

# Healthy Heart, Healthy Family

A Community Health Worker's Manual for the Filipino Community



U.S. Department of Health and Human Services  
National Institutes of Health  
National Heart, Lung, and Blood Institute

# Healthy Heart, Healthy Family

A Community Health Worker's Manual for the Filipino Community



**U.S. Department of Health and Human Services**  
National Institutes of Health



**National Heart  
Lung and Blood Institute**  
People Science Health

NIH Publication No. 08-6339  
September 2008



# Table of Contents

Dear Community Health Worker Letter..... v

## **introduction**

The Role of the Community Health Worker ..... vii  
Acknowledgments..... viii  
About the “Healthy Heart, Healthy Family” Manual..... xiv  
How To Use This Manual..... xv

## **session 1**

Knowledge Is Power: Know Your Risk for Heart Disease ..... 1

## **session 2**

Act in Time to Heart Attack Signs ..... 29

## **session 3**

Get Energized! Say YES to Physical Activity..... 57

## **session 4**

Help Your Heart: Control Your High Blood Pressure ..... 95

## **session 5**

Be Heart Smart: Keep Your Cholesterol in Check ..... 143

## **session 6**

Keep The Beat: Aim for a Healthy Weight ..... 193

## **session 7**

Protect Your Heart: Prevent and Control Diabetes..... 233

## **session 8**

Welcome Heart Healthy Eating Into Your Home ..... 283



## **session 9**

Eat in a Heart Healthy Way—Even When Time or Money Is Tight ..... 325

## **session 10**

Take Control of Your Health: Enjoy Living Smoke Free ..... 361

## **session 11**

Review and Graduation ..... 401

## **session 12**

Use Evaluation To Track Your Progress  
(*Especially for Community Health Workers*) ..... 435

## **appendix**

Activities for Training Community Health Workers ..... 495

**for more information**..... 524

## Dear Community Health Worker:

Cardiovascular disease (CVD) is the #1 killer of all Americans and is one of the leading causes of death among Filipino Americans. High blood pressure, high blood cholesterol, overweight/obesity, smoking, not being physically active, and diabetes are all factors that increase a person's risk of CVD. The good news is that people can lower their risk by making some lifestyle changes, and community health workers like you can help. The "Healthy Heart, Healthy Family" manual can guide you as you begin this journey.

"Healthy Heart, Healthy Family" is a heart health manual created especially for Filipino American communities by the National Heart, Lung, and Blood Institute (NHLBI) at the National Institutes of Health (NIH), U.S. Department of Health and Human Services (DHHS). The manual is taught by community health workers and focuses on helping people build skills to make practical, lasting changes to help fight heart disease and to improve their health. You will notice that cultural adaptations are used to make the manual more appealing and relevant to Filipino American communities.

The "Healthy Heart, Healthy Family" manual provides all the information you need to put this heart health project into action in your community. This manual can be used to train community health workers as well as to educate members of the Filipino American community, or it can serve as the basis for other community activities.

"Healthy Heart, Healthy Family" is dedicated to community health workers like you who devote time and energy to help others improve their health and live longer. Thank you for making a difference.

Much success,

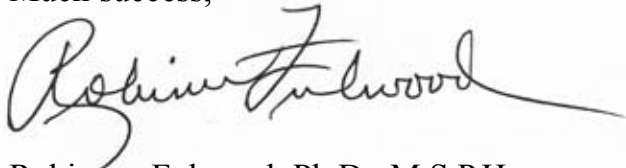

Robinson Fulwood, Ph.D., M.S.P.H.

Chief

Enhanced Dissemination and Utilization Branch

Division for the Application of Research Discoveries

National Heart, Lung, and Blood Institute



# i n t r o d u c t i o n

---

## **The Role of the Community Health Worker**

Community health workers play a key role in promoting better health in Filipino American communities. They help people learn about health issues and show them ways to live healthier lives. Without them, many Filipino Americans might not receive such vital information.

Successful community health workers have special qualities. They know their communities well. They are dedicated to improving the health of their communities. They enjoy teaching others, feel comfortable in front of a group, and know how to work with a group. Successful community health workers are also:

- Good listeners
- Caring
- Patient
- Fair
- Helpful
- Willing to try new ways to improve their own health
- Nonjudgmental
- Pleasant
- Approachable
- Openminded
- Confident

## **Let's Hear From You!**

We thank you for your interest and efforts to help Filipino Americans take steps to protect their hearts. We invite you to give us your feedback on how you are using the manual in your community.

Your feedback will help promote the expansion of the project in the United States and abroad and contribute to the growth of the Healthy Heart, Healthy Family network. Establishing a large network is important to keep the project going strong!

### **You may also send your feedback to:**

Healthy Heart, Healthy Family Project  
NHLBI/Division for the Application of  
Research Discoveries  
31 Center Drive, MSC 2480  
Bethesda, Maryland 20892-2480  
woov@mail.nih.gov.

# Acknowledgments

The “Healthy Heart, Healthy Family” manual was developed with the dedication of many people. NHLBI gratefully acknowledges the contributions of community health workers, families, individuals, groups, institutions, and organizations to the success of this manual. We appreciate the time they dedicated to reviewing the manual, sharing their knowledge, and providing continuous support:

Noilyn Abesamis-Mendoza, M.P.H.  
Center for the Study of Asian  
American Health  
New York University School of Medicine  
New York, NY

Also representing:  
Kalusugan Coalition, Inc.  
Queens, NY, and Jersey City, NJ

Nina Agbayani, R.N.  
Association of Asian Pacific Community  
Health Organizations (AAPCHO)  
Oakland, CA

David Aguilar, M.A.  
Project AsPIRE  
Center for the Study of Asian  
American Health  
New York University School of Medicine  
New York, NY

Also representing:  
Kalusugan Coalition, Inc.  
Queens, NY, and Jersey City, NJ

Sharonne Ancheta  
Kokua Kalihi Valley Comprehensive  
Family Services  
Honolulu, HI

Marcia Aquino, R.N.  
Association of Philippine Physicians  
in Maryland (APPM)  
Baltimore, MD

Gloria Balaiz  
Kokua Kalihi Valley Comprehensive  
Family Services  
Honolulu, HI

Norma Benzon  
Volunteer  
Sugar Land, TX

Michael Byun, M.P.A.  
Asian Service in Action  
Akron, OH

Sefie Cabiao  
International Community Health Services  
Seattle, WA

Yoyie Carlos-Castillo, R.N.  
Volunteer  
Hasbrouck Heights, NJ

Norma Castillo, M.D.  
Association of Philippine Physicians in  
Maryland (APPM)  
Baltimore, MD

Hong Chartrand, M.P.A., M.A.  
Asian Pacific Community in Action  
Phoenix, AZ

Merlita Compton  
Kokua Kalihi Valley Comprehensive  
Family Services  
Honolulu, HI

Ofelia Dirige, Dr.P.H., R.D.  
Kalusugan Community Services  
National City, CA

Chin Du, M.P.H., M.Ed.  
Health Promotion Council of Southeastern  
Pennsylvania, Inc.  
Philadelphia, PA

Lien Du  
Vietnamese Association of Illinois  
Chicago, IL

Diep N. Duong, R.N., Ph.D.  
Lt. Col., USAF, NC  
HQ PACAF/XPH  
Pacific International Health Affairs  
South East Asia Desk (Burma, Cambodia,  
Laos, Viet Nam)  
Hickam AFB, HI

Rico Foz  
Project AsPIRE  
Center for the Study of Asian  
American Health  
New York University School of Medicine  
New York, NY

Also representing:  
Kalusugan Coalition, Inc.  
Queens, NY, and Jersey City, NJ

Purificacion Gac, M.D.  
Volunteer  
Honolulu, HI

Jesus Guarin  
Kokua Kalihi Valley Comprehensive  
Family Services  
Honolulu, HI

Beverly J. Quan Gor, Ed.D., R.D., L.D.,  
C.D.E.  
Center for Research on Minority Health  
University of Texas  
M.D. Anderson Cancer Center  
Houston, TX

John Paul Jael  
Asian Human Services  
Chicago, IL

Edwin Jocson  
West Bay Filipino Multi-Service Center  
San Francisco, CA

Miyong T. Kim, R.N., Ph.D., FAAN  
School of Nursing  
Johns Hopkins University  
Baltimore, MD  
Tana M. Le  
West Seventh Community Center, Inc.  
St. Paul, MN

Marichu Lee  
Volunteer  
Honolulu, HI

Harvey Lee  
Institute for Family Enrichment  
Honolulu, HI

Donna R. Lew  
American Heart Association  
San Francisco, CA

Maria Macatumbas  
Kokua Kalihi Valley Comprehensive  
Family Services  
Honolulu, HI

Potri R. Manis, R.N.  
Project AsPIRE  
Kalusugan Coalition, Inc.  
Queens, NY, and Jersey City, NJ

Carmen Lavilla-Cortez, Ph.D.  
Kalusugan Coalition, Inc.  
Queens, NY, and Jersey City, NJ

Estrella B. Manio, M.S., R.N., P.N.P.  
Chair, Filipino Community  
Health Council  
American Heart Association  
San Francisco, CA

Melen McBride, R.N., Ph.D.  
Stanford Geriatric Education Center  
Center for Education in Family and  
Community Medicine  
Stanford University School of Medicine  
Palo Alto, CA

Mary Cheryl B. Nacionales, M.P.H.,  
CHES  
Women's Health Partnership Director  
Community Health Partnership  
San Jose, CA

Vilma Nafarrete-Braga, L.M.S.W.  
Filipino American Human Services, Inc.  
Jamaica, NY

Phi-Loan Nguyen  
Boat People SOS  
Washington, DC

Phi-Nhung (Nina) Nguyen  
Boat People SOS  
Washington, DC

Thang D. Nguyen, Ph.D.  
Boat People SOS  
Falls Church, VA

Thoa Nguyen  
Vietnamese Community Health Promotion  
Project–UCSF  
Health is Gold!  
San Francisco, CA

Mario Oliveros  
Volunteer  
Santa Clara, CA

Leo Pandac, Ph.D.  
Pacific Asian Alcohol and Drug Program  
Los Angeles County Refugee  
Service Center  
Los Angeles, CA

Dung Pham  
Vietnamese Social Services of Minnesota  
(VSSMN)  
Vietnam Center  
St. Paul, MN

Melga R. Rodriguez, M.A.Ed.  
Department of Public Health  
City and County of San Francisco  
Bicol University  
Legazpi City, Philippines

Teodulfo V. Rodriguez  
Volunteer  
Baypoint, CA

La Sarmiento, L.M.T.  
Volunteer  
Washington, DC

Fe Seligman  
Operation Samahan Health Clinic  
National City, CA

Henry Soliveres  
Project AsPIRE  
Center for the Study of Asian  
American Health  
New York University School of Medicine  
New York, NY  
Also representing:  
Kalusugan Coalition, Inc.  
Queens, NY, and Jersey City, NJ

Ho L. Tran, M.D., M.P.H.  
Asian & Pacific Islander American Health  
Forum (APIAHF)  
San Francisco, CA

Rhodora Ursua, M.P.H.  
Project AsPIRE  
Center for the Study of Asian  
American Health  
New York University School of Medicine  
New York, NY  
Also representing:  
Kalusugan Coalition, Inc.  
Queens, NY, and Jersey City, NJ

Mila Velasquez, M.N., R.N., C.S.,  
APRN, BC  
Philippine Nurses Association of America  
Cerritos, CA

Dia Kim Vu  
Vietnamese Social Services of Minnesota  
(VSSMN)  
St. Paul, MN

Candice Wong, M.D., Ph.D.  
University of California, San Francisco  
Department of Physiological Nursing  
San Francisco, CA

Jing Zhang, Ph.D.  
Asian Human Services, Inc.  
Chicago, IL



## Special Recognition

NHLBI extends special recognition to the following individuals and organizations for assisting NHLBI in helping make the material culturally appropriate and for sampling selected sessions and/or activities of the manual with the community:

- Theresa P. Castillo, M.A., C.H.E.S.  
Public Health Fellow  
U.S. Department of Health and Human Services  
Emerging Leaders Program  
Bethesda, MD
- Center for the Study of Asian American Health  
New York University School of Medicine  
New York, NY
- American Heart Association  
Asian Cultural Health Initiatives  
San Francisco, CA
- Kalusugan Coalition, Inc.  
Queens, NY, and Jersey City, NJ

May the “Healthy Heart, Healthy Family” manual lead to a new cycle of action to strengthen and sustain heart health in the Filipino American communities.

## **NHLBI Staff**

Matilde Alvarado, R.N., M.S.N.  
Coordinator  
Minority Health Education and  
Outreach Activities  
Division for the Application of  
Research Discoveries  
Bethesda, MD

Janet de Jesus, M.S., R.D.  
Nutrition Education Specialist  
Division for the Application of  
Research Discoveries  
Bethesda, MD

Robinson Fulwood, Ph.D., M.S.P.H.  
Chief  
Enhanced Dissemination and  
Utilization Branch  
Division for the Application of  
Research Discoveries  
Bethesda, MD

Madeleine Wallace, Ph.D.  
Public Health Analyst  
Division for the Application of  
Research Discoveries  
Bethesda, MD

Terri Williams, M.S.A.  
Production Manager  
Division for the Application of  
Research Discoveries  
Bethesda, MD

Violet Ryo-Hwa Woo, M.S., M.P.H.  
Public Health Advisor  
Division for the Application of  
Research Discoveries  
Bethesda, MD

## **Contract Support**

IQ Solutions, Inc.  
Rockville, MD

# About the “Healthy Heart, Healthy Family” Manual

To teach the “Healthy Heart, Healthy Family” manual, the following materials are needed:

- “Healthy Heart, Healthy Family” manual and picture cards
- “Filipinos Take It to Heart: A ‘How-To’ Guide for Bringing Heart Health to Your Community” highlights steps that can be taken to implement successful awareness-raising and health-promoting activities in the community to prevent and control cardiovascular risk factors.
- Six easy-to-read bilingual booklets on heart healthy living:
  - Are You at Risk for Heart Disease?
  - Help Your Heart: Control Your High Blood Pressure
  - Keep the Beat: Aim for a Healthy Weight
  - Be Heart Smart: Keep Your Cholesterol in Check
  - Protect Your Heart: Prevent and Control Diabetes
  - Be Heart Healthy: Enjoy Living Smoke Free

Ordering information for these materials appears in the Appendix.

# How To Use This Manual

**Community health workers, this manual is for you!** The “Healthy Heart, Healthy Family” manual can be used to train community health workers. After you have been trained, you can conduct your own trainings and teach others how to be community health workers.

The “Healthy Heart, Healthy Family” manual consists of 12 sessions that include step-by-step instructions on how to teach 11 fun and educational sessions to community residents or patients. Each session is taught in motivational and interactive ways to keep the attention of the group members. Each session helps people learn what they can do to prevent heart disease. The manual includes worksheets and handouts for project participants (group members) to take home to read and share with family and friends.

It also includes a special session for community health workers on how to evaluate completed projects. This session helps community health workers determine how successful they have been in implementing their training and educational activities and helping community residents to adopt heart healthy habits. The Appendix features special training activities and teaching tips and explains how to start a project in their own communities. (See pages 495–525.)

## “Healthy Heart, Healthy Family” Sessions

1. Knowledge Is Power: Know Your Risk for Heart Disease
2. Act in Time to Heart Attack Signs
3. Get Energized! Say YES to Physical Activity
4. Help Your Heart: Control Your High Blood Pressure
5. Be Heart Smart: Keep Your Cholesterol in Check
6. Keep The Beat: Aim for a Healthy Weight
7. Protect Your Heart: Prevent and Control Diabetes
8. Welcome Heart Healthy Eating Into Your Home
9. Eat in a Heart Healthy Way—Even When Time or Money Is Tight
10. Take Control of Your Health: Enjoy Living Smoke Free
11. Review and Graduation
12. Use Evaluation To Track Your Progress (*Especially for Community Health Workers*)

## Session Outline

Each session begins with a summary page that explains:

- What you want group members to do or learn
- Materials and supplies that you will need
- Worksheets and materials that you will hand out
- The session outline

Each session also includes five major parts:

### ■ Part 1—Introducing the Session

- Welcome the group members.
- Review the information from the last session.
- Ask the group members to talk about their pledges. (See Part 5, Pledge for Life!)
- Explain what you will talk about in today's session.

### ■ Part 2—Conducting the Session

- Present new information.
- Lead the group in fun and educational activities.
- Ask the group members questions.
- Let the group members ask questions about what they have heard.

### ■ Part 3—Review of Today's Key Points

- Ask questions to help the group members review what they have just learned.
- Emphasize the important points.

## ■ Part 4—Lola’s Life Lessons: A Time To Reflect

- Lola shares her wisdom and the heart health changes she made to her lifestyle behavior.
- She shares how she inspired heart health changes in her family and friends.

## ■ Part 5—Pledge for Life!

- Help group members choose at least one activity to make healthy lifestyle changes that relate to the information they have learned during the session.

## ■ Part 6—Closing

- Tell the group members that you enjoyed holding the session, and wish them luck in meeting their pledges.
- Thank the group members for attending the session.
- Ask the group members what they thought of the session.

## Symbols

The following symbols are used throughout the manual to let you know quickly what comes next:



Do an activity.

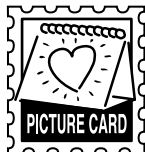

Use a picture card.



Give out a handout.



Help group members create a pledge for heart health.



Give out a recipe.



Do a training activity.

## Picture Cards

You will use the “Healthy Heart, Healthy Family” picture cards with the manual to help present the information for each session. When you see the picture card symbol in the manual, you will know to show a picture that relates to the information you will be talking about. On the back of each picture card is a script in English and in Tagalog that you can read aloud while you show the picture card.

## Breaks and Refreshments

You should take a short break about halfway through each session. You may want to use the time to do some easy stretches (see the “Stretching Activities” handout on pages 86-88). Another option is to serve a small healthy snack with water during the break. Snack ideas include light yogurt or fruit, or vegetables with low-fat dip, and water. Or you can make one of the recipes from this manual and have group members taste it.

## Getting Started

### At Least 6 Weeks in Advance

1. **Find a location.** Find a place to teach “Healthy Heart, Healthy Family” sessions in your area that people can get to easily. Call local clinics, schools, churches, and community centers. Reserve a room at a time when community members can attend.
2. **Tell people about the project.** Let community leaders and others know that you are offering the course. Ask clinic personnel, clergy, and caseworkers to recommend it.

## ■ Say:

These are some of the benefits of the course:

- The course can help participants and their families find out their own risk for heart disease and learn how to lead healthier lives.
  - Participants will learn low-cost cooking techniques, as well as how to eat healthy foods, prevent heart disease, become more physically active, keep a healthy weight, prevent and control diabetes, and quit smoking.
  - The course is also for participants who have risk factors for heart disease or are under the care of a doctor because of heart disease. This course will guide participants to take steps to protect and improve their heart health.
  - Participants will learn that, whatever your age or current health status, it is never too late to take steps to protect your heart.
3. **Advertise the sessions.** Post flyers at health fairs and in community sites, such as clinics, grocery stores, churches, and other places in your community. (See the sample flyer on pages xxiii and 505.) Place course announcements in local media outlets.
  4. **Class size.** A small group of about 10 to 12 people is best. Try to get about 20 people to sign up, because some may not show up for the class, and others may drop out.

## At Least 1 Week Before Each Session

1. **Read through the sessions, picture cards, and handouts.** Read through these materials two or three times to be prepared.
2. **Carefully read the information that you will present to the group members.** Practice what you will say in front of a mirror or to a friend or family member. Be sure to use the picture cards. Also practice making a few healthy changes in your own life.
3. **Review the instructions for each activity.** Make a list of things you need to do before the session, such as making a food display or getting a videocassette recorder (VCR)/video home system (VHS), or DVD, and TV monitor. For some sessions, you will need to create lists of places where people can get their blood pressure, blood glucose (test for diabetes), or blood cholesterol checked.



4. **Pay attention to the “More Information” boxes.** This extra information helps you answer questions from the group.
5. **Ask a health educator, registered dietitian, nurse, or doctor to explain any information you do not understand.** Contact these health professionals at your local hospital or neighborhood clinic.
6. **Review the list of handouts, materials, and supplies you will need for each session.**
  - Make enough copies of the handouts for all group members.
  - Gather all the materials and supplies needed to conduct the session.

## **The Day of the Session**

1. **Review the list of materials, supplies, and handouts.** Make sure that you have everything.
2. **Arrive 30 to 60 minutes ahead of time.** This will allow you to set up the room, VCR/VHS, or DVD and TV monitor.
3. **Tell group members when sessions will meet and how often.**

## **Working With Your Group**

### **Leading the Group**

- **Get to know the members of your group.** They may have different backgrounds, interests, and needs.
- **Use words and terms that are familiar to the people in your group.**
- **Encourage group members to ask questions.** Asking questions helps group members apply the information to their own lives and remember what they have learned.
- **Keep the sessions flowing smoothly so everyone is interested and involved.**
  - Be ready to deal with people who talk too much. Thank these people for sharing their opinions. Then quickly ask if anyone else has something to share.

- Help group members who do not read or write well in a way that will not bring attention to them.
- Offer help, but do not force anyone to accept help.
- Change the activity to a group discussion.

■ **Be observant.** Watch for clues from group members who do not understand or do not want to share their thoughts, and try to give the information in a different way if you see these clues:

- Puzzled looks
- Wrinkled foreheads
- Looking away from you
- Being quiet

## Motivating Group Members

■ **Praise or reward group members' efforts in order to keep them motivated.**

- Give praise when it is deserved. This gives more meaning to what you are teaching.
- Praise people in front of others. This can help them stay committed.

■ **Encourage group members to share their opinions.**

- Show interest in group members and what they have to say.
- Be patient. Some people may not speak because they have never been asked to share their opinions in a group setting.
- Try to involve everyone in the discussion and activities, but do not force anyone to speak. People will speak up when they become used to the group.

■ **Encourage participants to take small steps toward change.**

- People are more likely to develop new habits if you promote small changes slowly. This brings more success.

## Getting People To Come

■ **Remind the group members that it is important to come to all the sessions.**

Tell them that they will:

- Learn something new at each session.
- Help family members.
- Socialize and meet new people.

■ **Ask people to team up and call one another as a reminder to attend the sessions.** This encourages people to attend.

■ **Remind them of the meeting time and how long the sessions will last.**

## Answering Hard Questions

Remember that it's okay not to know all the answers! Say that you will have the correct answer by the next session. Call a local health educator, registered dietitian, or nurse to find out the correct information.

## Keeping People on Track

Give the correct information when a group member gives incorrect or incomplete information. Give the person credit for any part of his or her answer that is correct. Say that people often receive incorrect information and believe it to be true. Tell the group members that this is one important reason why they are taking the course—to get correct information.

## And Finally . . .

Have a good time. You are doing an important service for yourself and your community. Thank you!

# Did You Know...

**Heart disease is one of the leading causes of death among Asians and Native Hawaiians and other Pacific Islanders.**

**In the Healthy Heart, Healthy Family project, you will:**

- ✓ Learn how to keep your heart and your family's hearts healthy.
- ✓ Find ways to increase your physical activity, eat in a heart healthy way, keep a healthy weight, and not smoke.
- ✓ Learn how to talk to your family, neighbors, and friends about heart disease.
- ✓ Enjoy videos, games, role playing, and other activities that make learning fun.
- ✓ Get take-home materials that you can share with others.

**Classes meet once a week for 11 weeks.**

Sponsored by: \_\_\_\_\_

Location: \_\_\_\_\_

Day/Time: \_\_\_\_\_

Classes begin on: \_\_\_\_\_

For more information or to register, contact: \_\_\_\_\_

**An Ounce of Prevention Is Worth a Pound of Cure!**

**The course is free.**



**Everyone who completes the classes will receive a certificate.**



**U.S. Department of Health and Human Services**  
National Institutes of Health



**National Heart  
Lung and Blood Institute**  
People Science Health

## **Begin With a Heart**

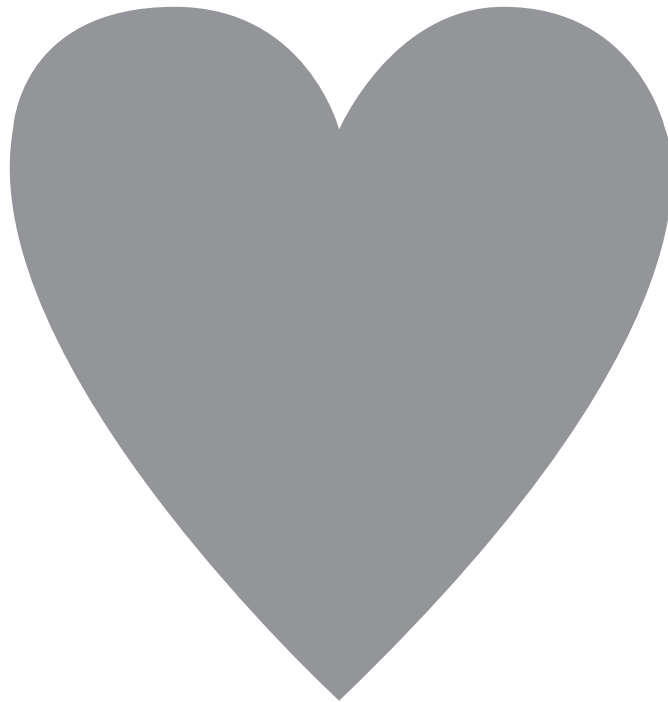

Use this shape to cut out the heart.  
You will use these heart shapes in Session 1. (See page 3.)

# Knowledge Is Power: Know Your Risk for Heart Disease

---

## Objectives

By the end of this session, group members will:

- Know about the Healthy Heart, Healthy Family project.
- Know how the heart works and its importance.
- Know that heart disease is a serious health problem for Filipinos and is one of the leading causes of death.
- Know that heart disease can be prevented.
- Be able to name six risk factors for heart disease that can be prevented.
- Know other group members.

---

## Materials and Supplies

To conduct this session, you will need:

- “Healthy Heart, Healthy Family” manual and picture cards
- Name tags
- Hearts cut from red felt (try to get the kind that has a sticky backing) or red construction paper. Use the shape on page xxiv to cut out the heart.
- Safety pins if not using felt with sticky backing

- Map of the Philippines
  - Pushpins
  - Blackboard and chalk or several large pieces of paper, a marker, and tape
  - Clear container that is filled with 1 liter (about 4 cups) of water
- 

## **Handouts**

**Give each group member these handouts during this session:**

- “Map of the Philippines” (page 22)
  - “Meet the de la Cruz Family” (page 23)
  - “Are You at Risk for Heart Disease?” (page 24)
  - A Day With the de la Cruz Family (pages 25–26)
  - “Lola’s Life Lessons: Session 1” (page 27)
- 

## **Session Outline**

### **Introducing the Session**

1. Welcome
2. Project Overview
3. Course Rules

### **Conducting the Session**

1. Getting To Know Each Other
2. Getting To Know the Strength of the Heart
  - A. How the Heart Works
  - B. The Heart’s Structure

3. Facts About Heart Disease
4. Risk Factor Activity
5. A Day With the de la Cruz Family (*Optional*)

## Review of Today's Key Points

### Closing



**Note:** Read the “More Information” chart on pages 17–21 to be ready to answer questions from group members.

## Introducing the Session

---

### 1. Welcome

- **Introduce** yourself as people walk in.
- **Ask** each person his or her name. **Write** it on a name tag. **Give** each person a name tag and a felt or paper heart.
- **Ask** group members to wear the name tags on their shirts. **Ask** them to place the felt or paper hearts where their own hearts are found.
- **Welcome** group members to the session. **Tell** them that you are very happy to see them.

### 2. Project Overview

- **Say:**

Heart disease is the #1 reason why people die in this country. The National Heart, Lung, and Blood Institute, part of the National Institutes of Health, created the Healthy Heart, Healthy Family project to help Filipinos prevent heart disease.



■ **Say:**

Together, we will learn about the risk factors for heart disease. We will also learn things that you and your family can do to have healthy hearts.

■ **Show** the names of the 11 sessions on the blackboard or on a large piece of paper taped to the wall.

1. “Knowledge Is Power: Know Your Risk for Heart Disease”
2. “Act in Time to Heart Attack Signs”
3. “Get Energized! Say YES to Physical Activity”
4. “Help Your Heart: Control Your High Blood Pressure”
5. “Be Heart Smart: Keep Your Cholesterol in Check”
6. “Keep The Beat: Aim for a Healthy Weight”
7. “Protect Your Heart: Prevent and Control Diabetes”
8. “Welcome Heart Healthy Eating Into Your Home”
9. “Eat in a Heart Healthy Way—Even When Time or Money Is Tight”
10. “Take Control of Your Health: Enjoy Living Smoke Free”
11. “Review and Graduation”

■ **Say:**

Please come to all of the sessions. I will lead the sessions, but I need each of you to participate. This will help you learn the information and enjoy the sessions more. Please feel free to ask questions. Your questions also help others to learn.

■ **Say:**

For some, the knowledge or information we cover may be as straightforward and simple as tying your shoe.

To others, the sessions may introduce lots of new information. This may be as challenging as taking care of a sampaguita plant in cold weather so it grows into a strong, beautiful flower.

If there is something you do not understand, please ask a question. Your questions also help others to learn.

Hearing information, especially new information, is not the same as carrying out what the information says. I hope what you learn will help you and your family take action to prevent heart disease.

### 3. Course Rules



**Note:** This section will help group members feel comfortable with each other at these sessions. It also will make it easier for you to lead the sessions.

■ **Say:**

Everyone will feel more at ease if they know what to expect from this project. Before we begin, let's talk about the best way to run the sessions. Let's agree as a group on a few basic rules.

■ **Say:**

This course takes effort and time from each group member. It is important for you to attend each session and to arrive on time. Each of the sessions is about 2 hours long.

■ *Optional* (if you are able to make changes) **Ask:**

- How often do you want to meet (once a week, twice a week, etc.)?
- Is this a good time to meet?



**Note:** If not, set a meeting time and location that is best for most of the group.

■ **Ask:**

Is this a good place to meet?



**Note:** If not, decide on a location that is best for most of the group.

■ **Say:**

Here are some things you can do to help you learn the most from the sessions.

1. Feel free to ask questions.
2. Share your personal experiences. This will make the project mean more to all of us.
3. Try to stay on the subject. We have a lot of information to talk about in a short time.
4. *(Optional)* Call me at [telephone number] if you have questions or concerns about this course. I am here to help you in any way that I can.

■ **Say:**

Because you will share your experiences and opinions, we need to agree on a few things.

■ **Ask:**

- Do you agree to keep other group members' comments to yourself?
- Do you agree not to judge others?
- Do you agree to try to come to all of the sessions?

■ **Ask:**

Do you have other rules that you would like to talk about?



**Note:** Allow a few minutes for group members to respond.

■ **Ask:**

How many of you have heard this Ilocano proverb? The proverb reads, “*Ang karunungan ay kayamanan mo, na di maaring manakaw sa iyo,*” which means, “Knowledge is wealth that cannot be stolen.”

■ **Ask:**

Would someone like to share what this proverb means to you?



**Note:** Allow 2 to 3 minutes for group members to respond.

■ **Say:**

With knowledge, you can make positive changes in your life to keep your heart healthy. Later in this session, you will meet the de la Cruz family, and they will share with us their journey to heart health.

## Conducting the Session

---

### 1. Getting To Know Each Other

■ **Say:**

We will begin today's session by introducing ourselves and getting to know each other a little better.



**Note:** Before the session, post the map in a central place in the room. Keep the pushpins nearby for this activity.

- **Give** group members the “My Family Is From...” handout (page 22), and **show** the map of the Philippines.



- **Ask** group members to:

- Give their names and tell one or two things about themselves (for example, where in the Philippines their families are from, or how long they have been living in the United States).
- Tell why they came to this course and what they hope to learn.



**Note:** Start this activity by going first. Tell the group where your family is from in the Philippines and why you are interested in heart health. Be honest, and talk about your own personal experience. Give each group member a chance to answer. Use the pushpins to mark on the map where the group members' families come from in the Philippines.

■ **Say:**

While our families may come from different parts of the Philippines, we all view the family as the backbone of support, knowledge, and love. You can help your family and friends by being a good example, sharing with them what you learn, and encouraging them to live healthier lives. Thank you for making this effort.

■ **Say:**

I would like to introduce you to another family that will help guide us through each of these sessions, the de la Cruz family.

- **Give** each group member the “Meet the de la Cruz Family” handout (page 23). **Ask** for a volunteer to read.



## 2. Getting To Know the Strength of the Heart

■ **Say:**

Now that we know a little bit about each other and the de la Cruz family, let's get to know a few facts about the heart.

### A. How the Heart Works

■ **Say:**

The heart is a gift that represents strength, life, and love. The heart is an amazing part of the body. It can pump approximately 5 liters of blood every minute. It beats about 100,000 times a day.



**Note:** **Hold up** a clear container that has 1 liter (about 4 cups) of water in it. **Remind** the group that the heart pumps five times this amount of blood each minute.

■ **Say:**

The heart sends blood to the lungs to pick up oxygen. Then it delivers oxygen to all the cells in the body.

■ **Say:**

You can feel the beat of your heart by taking your pulse. To find your pulse, gently place the index and middle fingers of one hand on the inside wrist of your other hand. Slide your two fingers toward the thumb side of your wrist until you feel a slight beating.

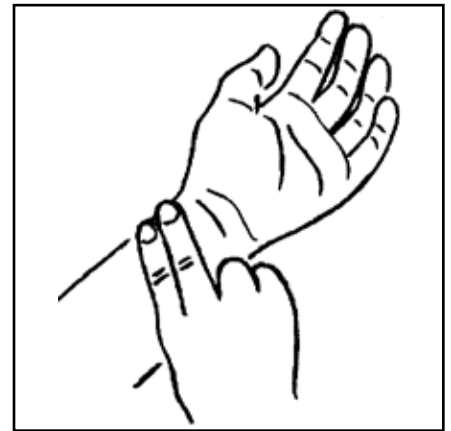

■ **Show** group members how to do this.

## **B. The Heart's Structure**

■ **Show picture card 1.1.**

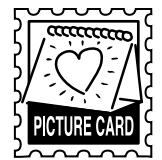

■ **Say:**

The heart is a hollow, muscular, cone-shaped organ, about the size of a fist.

■ **Hold up** your fist for the group members to see.

■ **Point** out each part of the heart on the picture card.

■ **Say:**

- The heart has two upper chambers and two lower chambers.
- The upper chambers (right atrium and left atrium) receive blood.
- The lower chambers (right ventricle and left ventricle) pump blood.

■ **Show picture card 1.2.**

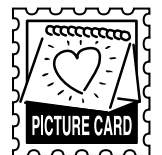

■ **Say:**

- The heart is located in the middle of the chest. Did you place your felt or paper heart in the correct spot?
- The heart is one of three main components of the circulatory system. The others are blood vessels and the blood.
- The circulatory system is very important for sustaining life and is made of all the vessels that carry the blood throughout the body.

- Blood vessels are long, hollow tubes of tissue, much like drinking straws. There are various kinds of blood vessels. The main ones are called arteries (shown in red), veins (shown in blue), and capillaries (not shown).
- The circulatory system delivers oxygen and nutrients to cells in your body and removes carbon dioxide and other waste products.

■ **Show picture card 1.3.**

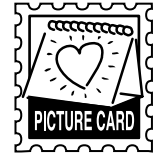

**Note:** Point to each artery and vein. Describe the following two steps while pointing to pictures 1 and 2.

■ **Say:**

Let's go over the major veins and arteries.

1. Blood (with little oxygen) enters the right top chamber of the heart through the largest veins in your body. These veins are called the superior and inferior vena cava.
2. Blood then flows down to the right lower chamber so it can be pumped out to the lungs through the pulmonary arteries. In the lungs, waste (carbon dioxide) is removed from the blood. The blood then gathers more oxygen.

■ **Show picture card 1.4.**

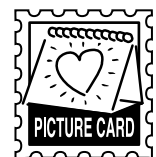

**Note:** Describe the two steps while pointing to pictures 3 and 4.

■ **Say:**

3. The blood, rich with oxygen, returns to the heart and enters the upper left chamber through the pulmonary vein.
4. The blood then flows down to the lower left chamber and is pumped out of the aorta to the rest of your body. Your left and right coronary arteries carry oxygen-rich blood to all parts of your heart.

■ **Say:**

Heart disease is a condition that affects the heart muscle, heart valves, or the vessels of the heart. The major form of heart disease is coronary heart disease. Because the heart is such an important organ, you want to keep it free from heart disease. When the heart stops, life stops. So when you take care of your heart, you take care of your life.

### 3. Facts About Heart Disease



**Note:** Before the session, read the “More Information” chart on pages 17–21. This chart lists the risk factors for heart disease that you can do something about. It gives you steps you can take to prevent or lower those risk factors.

■ **Say:**

Now that we know how important the heart is, let’s talk about heart disease and what we can do to protect our hearts.

■ **Ask:**

Do you know someone who has heart disease?



**Note:** Allow about 2 minutes for group members to respond.

■ **Show picture card 1.5.**

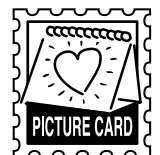

■ **Say:**

Heart disease is a serious health problem for Filipinos.

- It is one of the leading causes of death among Filipinos in the United States.
- Filipino women have higher rates of blood pressure compared to other Asian American women.
- In the Philippines, approximately 23 percent of Filipino adults (or one in four adults) have high blood pressure (140/90 millimeters of mercury [mmHg] or more).



■ **Say:**

- Many people believe that a heart attack or stroke happens suddenly, because of a scary experience, getting bad news, stress caused by work, family problems, worries, or having strong feelings such as anger.
- A heart attack or stroke may seem sudden, but the truth is that heart disease develops over many years. It often starts when you are very young.
- Taking steps to prevent heart disease is important at any age. It is like performing regular service on a car (for instance, changing the oil and checking the fluids and the tires). Car maintenance helps keep the engine running smoothly so that the car won't break down on the road. In the same way, you need to take steps to care for your body so you can lower your chances of getting heart disease.
- This course will show you the steps you and your family can take to have healthier hearts.

■ **Show picture card 1.6.**

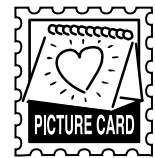

■ **Say:**

In many sessions, you will hear about something called a “risk factor.” Risk factors are traits or habits that make a person more likely to get heart disease. Some risk factors—such as age, family history, and gender—are things you cannot change. But the good news is that you can do something about some risk factors:

- High blood pressure
- High blood cholesterol
- Cigarette smoking
- Diabetes
- Overweight
- Not being physically active

## 4. Risk Factor Activity



- Give each group member the “Are You at Risk for Heart Disease?” handout (page 24). **Read** aloud each risk factor. As you read each one, **ask** group members to check off the risk factors they have.



- **Say:**

The more risk factors you have checked, the greater your risk for heart disease and stroke. Talk to your doctor about your risk.

- **Say:**

This session will explain how these risk factors affect the health of the heart. It will also teach you ways that you and your family can prevent or control those risk factors. You will learn how to:

- Lose weight if you are overweight.
- Be physically active.
- Cut down on salt and sodium.
- Eat foods that are lower in saturated fat and trans fat.
- Eat more fruits and vegetables and low-fat milk and milk products.
- Get your blood pressure, blood cholesterol, and blood glucose (blood sugar) levels checked.
- Take prescribed medications as your doctor tells you.
- Quit smoking if you smoke.



*(Optional) Note:* You can share information on *The Heart Truth* campaign described in the Appendix on page 506.

## 5. A Day With the de la Cruz Family (Optional)

### ■ Ask:

How did you feel when you learned that you or your loved one(s) have risk factors for heart disease?



**Note:** Allow 3 minutes for group members to answer.

- **Give** each group member the “A Day With the de la Cruz Family” handout (pages 25–26).



### ■ Say:

People act in different ways when they learn they must make changes in their habits to lower their risk for heart disease. Let’s read the examples from the “A Day With the de la Cruz Family” handout.

- **Ask** a volunteer to read the handout.



**Note:** You can make puppets to represent each member of the de la Cruz family from socks or paper bags. Use glue, markers, and other craft scraps to give your puppets features and costumes.

- **Add** these answers if they are not mentioned:

- Which family member do you identify with the most?
- What reasons do you have to improve your health?
- What barriers keep you from making daily changes?
- What can you do to reduce these barriers?

## Review of Today’s Key Points

### ■ Ask:

What are the risk factors for heart disease that we can prevent or control?

■ **Add** these answers if they are not mentioned:

- Overweight and obesity
- Not being physically active
- High blood pressure
- High blood cholesterol
- Diabetes
- Smoking

■ **Say:**

It may be hard to change old, unhealthy habits and learn new healthy ones. This course will teach you what you need to know and how to make these changes slowly. Seeing you make healthy changes may make others want to make these changes, too.

## Lola's Life Lessons: A Time To Reflect

---

■ **Ask:**

How did you feel (or how would you feel) when you learned that you or your loved ones have risk factors for heart disease? Allow 3 minutes for group members to answer.

■ **Say:**

In the de la Cruz family, Lola Idad will show us how she made healthy lifestyle changes.



**Note:** Give each group member the “Lola’s Life Lessons: Session 1” handout (page 27). **Ask** a volunteer to read the handout.



■ **Say:**

Please take a few minutes to reflect on Lola’s advice and how this applies to your life. At the bottom of the handout, there is a space called “A Time To Reflect.” Use this section to record your thoughts and feelings about this week’s session. Remember, this is for you and no one else.



**Note:** Give each group member 2 to 3 minutes to write down their thoughts.

## Closing

---

■ **Ask:**

Do you have any questions about the project?



**Note:** Give group members a moment to respond.

■ **Say:**

Thank you for coming today. What did you think of today’s session?



**Note:** Allow a moment for group members to respond.

■ **Say:**

In the next session, we are going to discuss the warning signs of a heart attack.



**Note for Educator:** Think about today’s session. What worked and what didn’t? Did the session help group members learn about their risk for heart disease?

## More Information

### Heart Disease Risk Factors You Can Do Something About

RISK FACTORS	FACTS YOU NEED TO KNOW	TAKE THESE STEPS TO PREVENT HEART DISEASE																		
<p><b>High blood pressure</b> High blood pressure (or hypertension) is called the silent killer because it often has no symptoms, yet it can cause very serious illness.</p> <p><b>Prehypertension</b> You do not have high blood pressure yet, but are likely to develop it in the future unless you adopt healthy lifestyle changes.</p>	<p>When your blood pressure is high, your heart works harder than it should to move blood to all parts of the body. If not treated, high blood pressure can lead to stroke (brain attack), heart attack, eye and kidney problems, and death.</p> <p><b>Check your blood pressure numbers (mmHg*):</b></p> <table border="1" style="width: 100%; border-collapse: collapse;"> <thead> <tr> <th style="width: 33%;">Level</th> <th style="width: 33%;">Systolic</th> <th style="width: 33%;">Diastolic</th> </tr> </thead> <tbody> <tr> <td>Normal</td> <td>Less than 120</td> <td>Less than 80</td> </tr> <tr> <td>Prehypertension</td> <td>120–139</td> <td>80–89</td> </tr> <tr> <td>High Blood Pressure</td> <td>140 or higher</td> <td>90 or higher</td> </tr> </tbody> </table> <p>*Millimeters of mercury</p>	Level	Systolic	Diastolic	Normal	Less than 120	Less than 80	Prehypertension	120–139	80–89	High Blood Pressure	140 or higher	90 or higher	<ul style="list-style-type: none"> <li>• Check your blood pressure once a year. Check it more often if you have high blood pressure.</li> <li>• Aim for a healthy weight.</li> <li>• Be physically active on most days.</li> <li>• Choose and prepare foods with less salt and sodium.</li> <li>• Eat more fruits, vegetables, and low-fat dairy products.</li> <li>• If you drink alcohol, do so in moderation.</li> <li>• If your doctor gives you blood pressure medicine, take it the way the doctor tells you.</li> </ul>						
Level	Systolic	Diastolic																		
Normal	Less than 120	Less than 80																		
Prehypertension	120–139	80–89																		
High Blood Pressure	140 or higher	90 or higher																		
<p><b>High blood cholesterol</b> Cholesterol in your arteries is like rust in a pipe.</p> <p>Low-density lipoprotein (LDL) is known as the “bad” cholesterol. Too much LDL cholesterol can clog your arteries, which increases the risk of heart disease and stroke.</p> <p>High-density lipoprotein (HDL) is known as the “good” cholesterol. HDL carries cholesterol away from your arteries.</p>	<p><b>Check your total blood cholesterol number (mg/dL*):</b></p> <table border="1" style="width: 100%; border-collapse: collapse;"> <thead> <tr> <th style="width: 60%;">Level</th> <th style="width: 40%;">Value</th> </tr> </thead> <tbody> <tr> <td>Desirable</td> <td>Less than 200</td> </tr> <tr> <td>Borderline High</td> <td>200–239</td> </tr> <tr> <td>High</td> <td>240 or higher</td> </tr> </tbody> </table> <p><b>Check your LDL cholesterol number† (mg/dL):</b></p> <table border="1" style="width: 100%; border-collapse: collapse;"> <thead> <tr> <th style="width: 60%;">Level</th> <th style="width: 40%;">Value</th> </tr> </thead> <tbody> <tr> <td>Desirable</td> <td>Less than 100</td> </tr> <tr> <td>Near Desirable/Above Desirable</td> <td>100–129</td> </tr> <tr> <td>Borderline High</td> <td>130–159</td> </tr> <tr> <td>High</td> <td>160 or higher</td> </tr> </tbody> </table> <p>*Milligrams per deciliter</p> <p>†The goal for LDL cholesterol is different for everyone. Your doctor can help you set your LDL goal.</p> <hr/> <p><b>Check your HDL cholesterol number (mg/dL):</b> HDL levels of 60 mg/dL or higher help lower your risk of heart disease. HDL levels below 40 mg/dL are a major risk factor for heart disease.</p> <hr/> <p><b>Check your triglyceride level (mg/dL):</b> A normal triglyceride level is below 150.</p>	Level	Value	Desirable	Less than 200	Borderline High	200–239	High	240 or higher	Level	Value	Desirable	Less than 100	Near Desirable/Above Desirable	100–129	Borderline High	130–159	High	160 or higher	<ul style="list-style-type: none"> <li>• Get a blood test called a lipid profile at your doctor’s office. This test measures all your cholesterol levels (total, LDL, and HDL) and triglycerides.</li> <li>• Get your blood cholesterol levels checked every 5 years if you are age† 20 or older.</li> <li>• Learn what your cholesterol numbers mean. If they are high, ask your doctor how you can lower them.</li> <li>• Choose foods that are lower in saturated fat, <i>trans</i> fat, and cholesterol.</li> <li>• Aim for a healthy weight.</li> <li>• Be physically active.</li> </ul> <p>Take these other steps to control triglycerides:</p> <ul style="list-style-type: none"> <li>• Limit candy, sweets, regular soda, juice, and other beverages high in sugar.</li> <li>• Avoid smoking and alcohol. Smoking raises triglycerides and lowers HDL cholesterol. Excess alcohol also raises triglycerides.</li> </ul>
Level	Value																			
Desirable	Less than 200																			
Borderline High	200–239																			
High	240 or higher																			
Level	Value																			
Desirable	Less than 100																			
Near Desirable/Above Desirable	100–129																			
Borderline High	130–159																			
High	160 or higher																			

## More Information

### Heart Disease Risk Factors You Can Do Something About *(continued)*

RISK FACTORS	FACTS YOU NEED TO KNOW	TAKE THESE STEPS TO PREVENT HEART DISEASE										
<p><b>Overweight/Obesity</b></p> <p>Overweight/obesity occurs when extra fat is stored in your body. It increases your risk of developing high blood pressure, high blood cholesterol, heart disease, stroke, and diabetes.</p>	<p>Check your body mass index (BMI) and waist measure:</p> <table border="1" style="margin-left: 20px;"> <thead> <tr> <th>Category</th> <th>BMI</th> </tr> </thead> <tbody> <tr> <td>Underweight</td> <td>&lt;18.5</td> </tr> <tr> <td>Normal</td> <td>18.5–24.9</td> </tr> <tr> <td>Overweight</td> <td>25–29.9</td> </tr> <tr> <td>Obese</td> <td>30 or greater</td> </tr> </tbody> </table> <ul style="list-style-type: none"> <li>• A waist measurement greater than 35 inches (88 cm) for a woman and greater than 40 inches (102 cm) for a man increases the risk of heart disease.</li> <li>• Other reports indicate that the BMI cutoffs for overweight (&gt;23.0 kg/m<sup>2</sup>) and obesity (&gt;25.0 kg/m<sup>2</sup>) in the Asian-Pacific region are lower than these current standards (Clinical Guidelines on the Identification, Evaluation, and Treatment of Overweight and Obesity in Adults).</li> </ul>	Category	BMI	Underweight	<18.5	Normal	18.5–24.9	Overweight	25–29.9	Obese	30 or greater	<ul style="list-style-type: none"> <li>• Get your BMI and waist measured every 2 years or more often if your doctor recommends it.</li> <li>• Aim for a healthy weight. Try not to gain extra weight.</li> <li>• If you are overweight, try to lose weight slowly. Lose 1 to 2 pounds (0.45 kg to 0.91 kg) a week.</li> <li>• Eat smaller portions and be physically active for at least 60 minutes daily.</li> </ul>
Category	BMI											
Underweight	<18.5											
Normal	18.5–24.9											
Overweight	25–29.9											
Obese	30 or greater											
<p><b>Diabetes</b></p> <p>When the sugar in the blood is high, your body cannot use the food you eat for energy.</p> <p><b>Prediabetes</b></p> <p>Prediabetes is when blood glucose levels are higher than normal, but not yet high enough to be diagnosed as diabetes. People with prediabetes are at higher risk of cardiovascular disease.</p>	<ul style="list-style-type: none"> <li>• Diabetes is serious. You may not know you have it. It can lead to heart attacks, blindness, amputations, and kidney disease.</li> <li>• Being overweight is a major risk factor for type 2 diabetes.</li> <li>• Filipino Americans are at higher risk for type 2 diabetes than the non-Hispanic Caucasian population.</li> </ul>	<ul style="list-style-type: none"> <li>• Find out if you have diabetes.</li> <li>• Get your blood glucose (blood sugar) level checked at least every 3 years, beginning at the age of 45. You should be tested at a younger age and more often if you are at risk for diabetes.</li> </ul>										
<p><b>Not being physically active</b></p> <p>Not being physically active can double your chances of heart disease and take years off your life.</p>	<ul style="list-style-type: none"> <li>• Adults should do at least 30 minutes of moderate physical activity on most days, preferably every day of the week.</li> <li>• Many adults need 60 minutes of moderate (medium-level) to vigorous (high-level) activity on most days, preferably every day of the week, to prevent unhealthy weight gain.</li> <li>• Adults who used to be overweight need 60 to 90 minutes of moderate physical activity every day to avoid regaining weight.</li> <li>• Children and adolescents need at least 60 minutes of moderate to vigorous physical activity on most days.</li> </ul>	<ul style="list-style-type: none"> <li>• Stay active. You can build up to 60 minutes of exercise each day by being active for 20 minutes three times a day.</li> <li>• Try walking, dancing, or playing basketball.</li> </ul>										
<p><b>Smoking</b></p> <p>You put your health and your family's health at risk when you smoke.</p>	<ul style="list-style-type: none"> <li>• Cigarette smoking is addictive. It harms your heart and lungs. It can raise your blood pressure and blood cholesterol and those of others around you.</li> </ul>	<ul style="list-style-type: none"> <li>• Stop smoking now, or cut back gradually.</li> <li>• If you cannot quit the first time, keep trying.</li> <li>• If you do not smoke, do not start.</li> </ul>										

## Karagdagang Impormasyon

### Mga Kadahilanan ng Peligro sa Sakit sa Puso na Maaari Mong Gawin

MGA KADAHILANAN NG PELIGRO	MGA KATOTOHANANG DAPAT MONG MALAMAN	GAWIN ANG MGA HAKBANG NA ITO UPANG MAIWASAN ANG SAKIT SA PUSO														
<p><b>Alta presyon</b> Ang mataas na presyon ng dugo (o alta presyon) ay tinatawag na tahimik na mamamatay tao sapagkat madalas na wala itong mga sintomas, ngunit maaari itong magsanhi ng napakaseryosong karamdaman.</p> <p><b>Pauna sa alta presyon</b> Hindi pa mataas ang presyon ng dugo mo, ngunit malamang na magkaroon nito sa hinaharap maliban kung nagamit mo ang mga malulusog na pagbabago sa uri ng pamumuhay.</p>	<p>Kapag mataas ang presyon mo sa dugo, nagtatrabaho nang husto ang iyong puso kaysa sa dapat nitong gawin upang mapaandar ang dugo sa lahat ng mga bahagi ng katawan. Kung hindi magagamot, maaaring humantong sa stroke ang mataas na presyon ng dugo (atake sa utak), atake sa puso, mga problema sa mata at bato, at pagkamatay.</p> <p>Suriin ang mga bilang ng iyong presyon sa dugo (mmHg*):</p> <table border="1" style="width: 100%; border-collapse: collapse;"> <thead> <tr> <th style="text-align: center;">Antas</th> <th style="text-align: center;">Systolic</th> <th style="text-align: center;">Diastolic</th> </tr> </thead> <tbody> <tr> <td style="text-align: center;"><b>Normal</b></td> <td style="text-align: center;">Mas mababa sa 120</td> <td style="text-align: center;">Mas mababa sa 80</td> </tr> <tr> <td style="text-align: center;"><b>Paunang alta Presyon</b></td> <td style="text-align: center;">120–139</td> <td style="text-align: center;">80–89</td> </tr> <tr> <td style="text-align: center;"><b>Mataas na Presyon</b></td> <td style="text-align: center;">140 o mas mataas</td> <td style="text-align: center;">90 o mas mataas</td> </tr> </tbody> </table> <p>*Millimetro ng mercury</p>	Antas	Systolic	Diastolic	<b>Normal</b>	Mas mababa sa 120	Mas mababa sa 80	<b>Paunang alta Presyon</b>	120–139	80–89	<b>Mataas na Presyon</b>	140 o mas mataas	90 o mas mataas	<ul style="list-style-type: none"> <li>• Suriin ang iyong presyon ng dugo minsan sa isang taon. Suriin ito nang mas madalas kung mayroon kang mataas na presyon ng dugo.</li> <li>• Maglayon ng isang malusog na timbang.</li> <li>• Maging aktibong pisikal sa mga nakararaming araw.</li> <li>• Pumili at maghanda ng mga pagkaing kaunti ang asin at sodium.</li> <li>• Kumain ng mas maraming mga prutas, gulay, at <i>low-fat</i> na mga produktong <i>dairy</i>.</li> <li>• Kung umiinom ka ng alcohol, gawin ang gayon nang katamtaman.</li> <li>• Kung binigyan ka ng iyong duktor ng gamot para sa presyon ng dugo, inumin ito sa paraang sinabi sa iyo ng duktor.</li> </ul>		
Antas	Systolic	Diastolic														
<b>Normal</b>	Mas mababa sa 120	Mas mababa sa 80														
<b>Paunang alta Presyon</b>	120–139	80–89														
<b>Mataas na Presyon</b>	140 o mas mataas	90 o mas mataas														
<p><b>Kolesterol sa mataas na presyon</b> Ang kolesterol sa iyong mga ugat ay tulad ng kalawang sa isang tubo.</p> <p><b>Low-density lipoprotein</b> Ang (LDL) ay kilala rin bilang “masamang” kolesterol. Ang labis na LDL kolesterol ay maaaring makabara sa iyong mga ugat, na nagpapataas ng peligro ng sakit sa puso at stroke.</p> <p><b>High-density lipoprotein</b> Ang (HDL) ay kilala bilang “mabuting” kolesterol. Inilalayo ng HDL ang kolesterol sa iyong mga ugat.</p>	<p><b>Suriin ang bilang ng iyong kabuuang kolesterol sa dugo (mg/dL*):</b></p> <table border="1" style="width: 100%; border-collapse: collapse;"> <tbody> <tr> <td style="text-align: center;"><b>Kanais-nais</b></td> <td style="text-align: center;">Mas mababa sa 200</td> </tr> <tr> <td style="text-align: center;"><b>Mataas na hangganan</b></td> <td style="text-align: center;">200–239</td> </tr> <tr> <td style="text-align: center;"><b>Mataas</b></td> <td style="text-align: center;">240 o mas mataas</td> </tr> </tbody> </table> <p><b>Suriin ang bilang** ng iyong LDL kolesterol (mg/dL):</b></p> <table border="1" style="width: 100%; border-collapse: collapse;"> <tbody> <tr> <td style="text-align: center;"><b>Kanais-nais</b></td> <td style="text-align: center;">Mas mababa sa 100</td> </tr> <tr> <td style="text-align: center;"><b>Malapit sa Kanais-nais/</b></td> <td style="text-align: center;">100–129</td> </tr> <tr> <td style="text-align: center;"><b>Mataas sa Kanais-nais</b></td> <td style="text-align: center;">130–159</td> </tr> <tr> <td style="text-align: center;"><b>Mataas na hangganan</b></td> <td style="text-align: center;">160 o mas mataas</td> </tr> </tbody> </table> <p>*Milligramo sa bawat deciliter</p> <p>†Ang layunin sa LDL kolesterol ay magkakaiba para sa bawat isa. Maaaring makatulong ang iyoong duktor sa pagtatakda mo ng iyong layunin sa LDL.</p>	<b>Kanais-nais</b>	Mas mababa sa 200	<b>Mataas na hangganan</b>	200–239	<b>Mataas</b>	240 o mas mataas	<b>Kanais-nais</b>	Mas mababa sa 100	<b>Malapit sa Kanais-nais/</b>	100–129	<b>Mataas sa Kanais-nais</b>	130–159	<b>Mataas na hangganan</b>	160 o mas mataas	<ul style="list-style-type: none"> <li>• Kumuha ng pagsusuri sa dugong tinawag na isang <i>lipid profile</i> sa opisina ng iyong duktor. Ang pagsusuring ito ay sumusukat ng lahat ng mga antas ng kolesterol (kabuuan, LDL, at HDL) at mga triglyceride.</li> <li>• Ipasuri ang mga antas ng iyong kolesterol sa dugo tuwing 5 taon kung ikaw ay nasa gulang na 20 o mas matanda.</li> <li>• Alamin kung ano ang kahulugan ng mga bilang ng iyong kolesterol. Kung mataas ang mga ito, tanungin ang iyong duktor kung paano pababain ang mga ito.</li> <li>• Pumili ng mga pagkaing mas mababa sa <i>saturated fat</i>, <i>trans fat</i>, at kolesterol.</li> <li>• Maglayon ng isang malusog na timbang.</li> <li>• Maging aktibong pisikal.</li> </ul> <p>Isagawa ang ibang mga hakbang na ito upang makontrol ang triglycerides:</p> <ul style="list-style-type: none"> <li>• Limitahan ang kendi, matatamis, regular na <i>soda</i>, inuming pritas, at iba pang mga inuming mataas sa asukal.</li> <li>• Iwasan ang paninigarilyo at alcohol. Nagpapataas ng triglycerides ang paninigarilyo at nagpapababa ng HDL kolesterol. Ang labis na alcohol ay nagpapataas din ng triglycerides.</li> </ul>
<b>Kanais-nais</b>	Mas mababa sa 200															
<b>Mataas na hangganan</b>	200–239															
<b>Mataas</b>	240 o mas mataas															
<b>Kanais-nais</b>	Mas mababa sa 100															
<b>Malapit sa Kanais-nais/</b>	100–129															
<b>Mataas sa Kanais-nais</b>	130–159															
<b>Mataas na hangganan</b>	160 o mas mataas															



## Karagdagang Impormasyon

### Mga Kadahilanan ng Peligro sa Sakit sa Puso na Maaari Mong Gawin

MGA KADAHILANAN NG PELIGRO	MGA KATOTOHANANG DAPAT MONG MALAMAN	GAWIN ANG MGA HAKBANG NA ITO UPANG MAIWASAN ANG SAKIT SA PUSO										
	<p style="text-align: center;">-----</p> <p>Suriin ang bilang ng iyong HDL kolesterol (mg/dL): Mga antas ng HDL ng 60 mg/dL o mas mataas ay makakatulong na babaan ang iyong peligro sa sakit sa puso. Ang mga antas ng HDL na mas mababa sa 40 mg/dL ay isang pangunahing kadahilanan ng peligro para sa sakit sa puso.</p> <p style="text-align: center;">-----</p> <p><b>Suriin ang iyong antas ng triglyceride (mg/dL):</b></p> <p>Ang isang normal na antas ng triglyceride ay mas mababa sa 150.</p>											
<p><b>Labis sa timbang/Sobrang katabaan</b></p> <p>Nangyayari ang paglabis sa timbang/sobrang katabaan kapag ang labis na taba ay naipon sa iyong katawan. Dinadagdagan nito ang iyong peligro sa pagkakaroon ng mataas na presyon ng dugo, kolesterol sa mataas na presyon ng dugo, sakit sa puso, stroke, at diyabetis.</p>	<p><b>Suriin ang iyong index sa bigat ng katawan (body mass index [BMI]) at sukat ng baywang:</b></p> <table border="1" style="width: 100%; border-collapse: collapse;"> <thead> <tr> <th style="text-align: left;">Kategorya</th> <th style="text-align: left;">BMI</th> </tr> </thead> <tbody> <tr> <td><b>Kulang sa timbang</b></td> <td>&lt;18.5</td> </tr> <tr> <td><b>Normal*</b></td> <td>18.5–24.9</td> </tr> <tr> <td><b>Labis sa timbang*</b></td> <td>25–29.9</td> </tr> <tr> <td><b>Sobra sa katabaan*</b></td> <td>30 o mas mataas</td> </tr> </tbody> </table> <ul style="list-style-type: none"> <li>• Ang isang sukat ng baywang na higit sa 35 pulgada (88 cm) para sa isang babae at higit sa 40 pulgada (102 cm) para sa isang lalaki ay nagpapataas ng peligro sa sakit sa puso.</li> </ul> <p>*Ipinapahiwatig ng iba pang mga ulat na ang hangganan ng BMI para sa labis sa timbang (&gt;23.0 kg/m<sup>2</sup>) at sobra sa katabaan (&gt;25.0 kg/m<sup>2</sup>) sa rehiyong Asya-Pasipiko ay mas mababa kaysa sa mga kasalukuyang pamantayan (Mga Tagubilin Pangklinika sa Pagkakakilala, <i>Pagsusuri, at Paggamot ng Labis sa Timbang at Sobra sa Katabaan sa Mga Nasa Hustong Gulang</i>).</p>	Kategorya	BMI	<b>Kulang sa timbang</b>	<18.5	<b>Normal*</b>	18.5–24.9	<b>Labis sa timbang*</b>	25–29.9	<b>Sobra sa katabaan*</b>	30 o mas mataas	<ul style="list-style-type: none"> <li>• Sukatin ang iyong BMI at baywtuwing 2 taon, o mas madalas kung inirekumanda ito ng duktora.</li> <li>• Maglayon ng isang malusog na timbang. Subukang huwag magdagdag ng timbang.</li> <li>• Kung labis ka sa timbang, subukang magbawas ng timbang nang dahan-dahan. Magbawas ng 1 hanggang sa 2 libra (0.45 kg hanggang sa 0.91 kg) sa isang linggo.</li> <li>• Kumain ng mas maliit na mga takal at maging aktibong pisikal nang hindi bababa sa 60 minuto araw-araw.</li> </ul>
Kategorya	BMI											
<b>Kulang sa timbang</b>	<18.5											
<b>Normal*</b>	18.5–24.9											
<b>Labis sa timbang*</b>	25–29.9											
<b>Sobra sa katabaan*</b>	30 o mas mataas											
<p><b>Diyabetis</b></p> <p>Kapag mataas ang asukal sa katawan, hindi magagamit ng iyong katawan ang pagkain sa lakas.</p> <p><b>Paunang diyabetis</b></p> <p>Ang paunang diyabetis ay kapag ang mga antas ng asukal sa dugo ay mas mataas sa normal, ngunit hindi pa rin sapat na mataas upang masuri bilang diyabetis. Ang mga taong may paunang diyabetis ay nasa mas mataas na peligro ng karamdaman sa cardiovascular.</p>	<ul style="list-style-type: none"> <li>• Ang diyabetis ay seryoso. Maaaring hindi mo alam na mayroon ka nito. Maaari itong humantong sa mga atake sa puso, pagkabulag, pagkaputol ng paa, at sakit sa bato.</li> <li>• Ang pagiging labis sa timbang ay isang pangunahing kadahilanan sa peligro para sa 2 uri ng diyabetis.</li> <li>• Ang mga Filipino American ay nasa mas mataas na peligro para sa 2 uri ng diyabetis kaysa sa populasyong hindi pang-Hispanikong Caucasian.</li> </ul>	<ul style="list-style-type: none"> <li>• Alamin kung mayroon kang diyabetis.</li> <li>• Ipasuri ang antas ng iyong asukal sa dugo (asukal sa dugo) nang hindi bababa sa minsan tuwing 3 taon, simula sa gulang na 45. Dapat kang masuri nang mas maaga at mas madalas kung nasa peligro ka ng diyabetis.</li> </ul>										

## Karagdagang Impormasyon

### Mga Kadahilanan ng Peligro sa Sakit sa Puso na Maaari Mong Gawin

MGA KADAHILANAN NG PELIGRO	MGA KATOTOHANANG DAPAT MONG MALAMAN	GAWIN ANG MGA HAKBANG NA ITO UPANG MAIWASAN ANG SAKIT SA PUSO
<p><b>Pagiging hindi aktibong pisikal</b></p> <p>Ang pagiging hindi aktibong pisikal ay maaaring magdoble ng iyong tsansa ng pagkakaroon ng sakit sa puso at maaaring makabawas ng taon ng iyong buhay.</p>	<ul style="list-style-type: none"> <li>• Ang mga nasa hustong gulang ay dapat na gumawa nang hindi bababa sa 30 minuto ng katamtamang aktibidad na pisikal sa nakararaming mga araw, nararapat araw-araw sa isang linggo.</li> <li>• Maraming mga nasa hustong gulang ang nangangailangan ng 60 minuto ng katamtamang (katamtamang antas) sa matitinding (mataas na antas) aktibidad sa mga nakararaming araw—dapat araw-araw—ng linggo, upang maiwasan ang hindi malusog na pagdaragdag ng timbang.</li> <li>• Ang mga nasa hustong gulang na dating labis sa timbang ay nangangailangan ng 60 hanggang 90 minuto ng katamtamang pisikal na aktibidad araw-araw upang maiwasan ang muling pagdaragdag ng timbang.</li> <li>• Ang mga bata at tinedyer ay nangangailangan nang hindi bababa sa 60 minuto ng katamtaman hanggang sa matitinding pisikal na aktibidad sa nakararaming mga araw.</li> </ul>	<ul style="list-style-type: none"> <li>• Manatiling aktibo. Maaari kang makabuo ng hanggang sa 60 minuto ng ehersisyo sa bawat araw sa pamamagitan ng pagiging aktibo nang 20 minuto tatlong beses isang araw.</li> <li>• Subukang maglakad, magsayaw, o maglaro ng basketball.</li> </ul>
<p><b>Paninigarilyo</b></p> <p>Inilalagay mo sa peligro ang kalusugan mo at ng iyong pamilya kapag nagsigarilyo ka.</p>	<ul style="list-style-type: none"> <li>• Ang paninigarilyo ay nakaka-addict. Nakakasama ito sa iyong puso at mga baga. Maaari nitong taasan ang iyong presyon ng dugo at cholesterol sa dugo at ang mga iba pa sa paligid mo.</li> </ul>	<ul style="list-style-type: none"> <li>• Tumigil na ngayon sa paninigarilyo, o dahan-dahang itigil ang paninigarilyo.</li> <li>• Kung hindi mo maitigil sa unang pagkakataon, laging subukin.</li> <li>• Kung hindi ka naninigarilyo, huwag magsimula.</li> </ul>

# My Family Is From ...

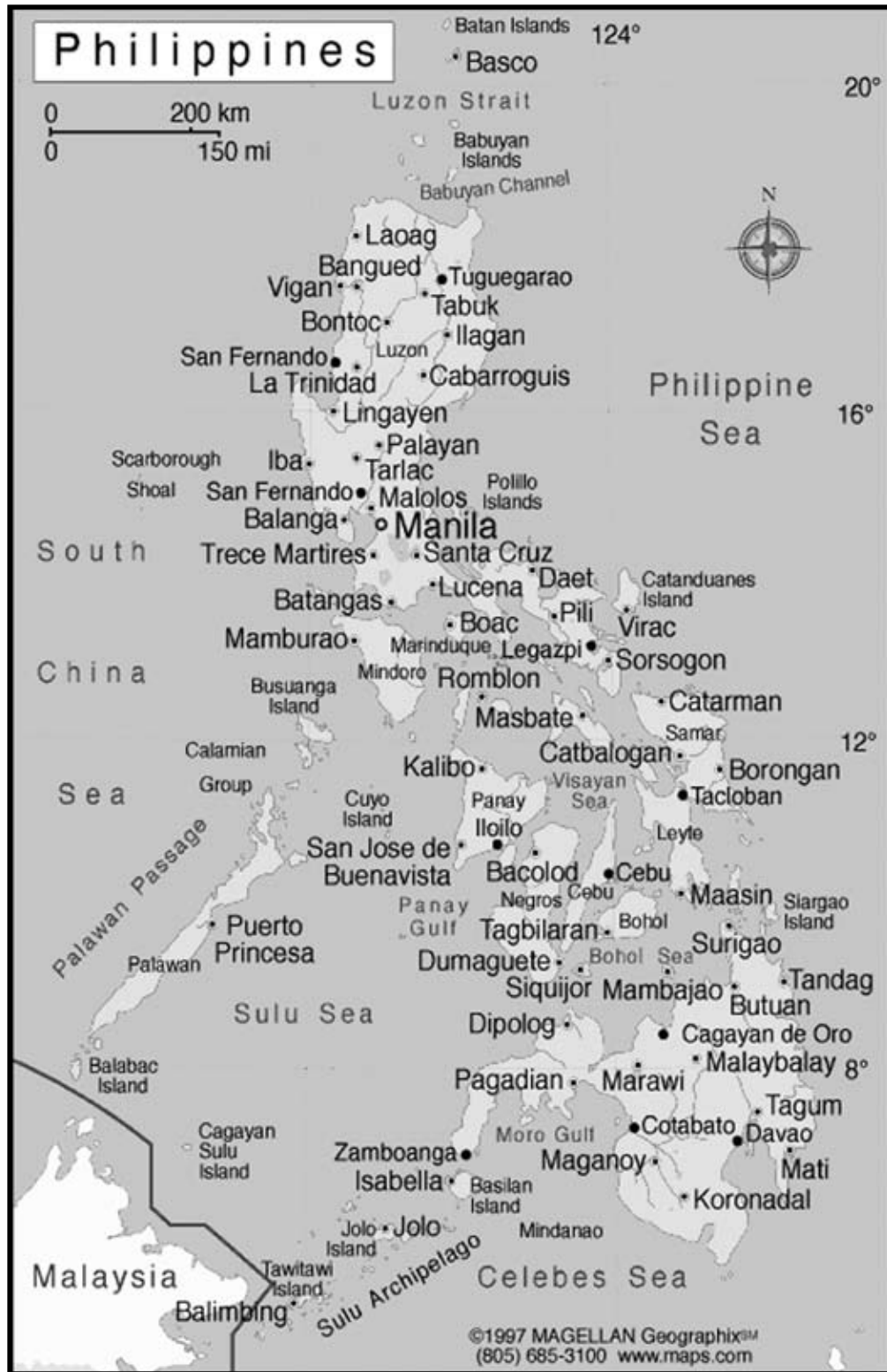

Source: Adapted from <http://i.infoplease.com/images/mphilipp.gif>.

# Meet the de la Cruz Family of Healthy Heart, Healthy Family

## A Filipino American Family's Journey



This manual tells the story of the de la Cruz family's successful journey to heart health. This family has encountered a lot of challenges since moving to the United States, but the de la Cruzes have found the strength to make positive changes in their lives.

With the grandmother's—*Lola Caridad's (Idad)\**— wisdom and determination, her family has achieved a healthy, well-balanced lifestyle. Lola wishes for all of her children to lead heart healthy lives. Only two of her children, Mila and Jose, and their families live close to her in the United States. Her other children still live in the Philippines, but they all visit each other and communicate often. Lola has learned from her mistakes that heart health is a gift to pass on to future generations, and she would like to share her knowledge with us as well.

Lola Idad will tell you the story of her family and show you how you can make the same journey to heart health. Although she knows the burden of heart disease can be overwhelming for a family, Lola will share practical steps that you can take to help keep your heart healthy. The sessions will help us learn from her family's example.

Respect the gift of heart health by choosing a healthy lifestyle for you and your family!

---

\* **“Lola”** is Tagalog for grandmother. Not only the family, but also the close network of community members respectfully addresses her as Lola. **“Idad”** is the nickname for her last name, Caridad.

# Are You at Risk for Heart Disease?

---

Name: \_\_\_\_\_

Risk factors are traits or habits that make a person more likely to develop heart disease. Read this list of risk factors for heart disease. Check the ones you have.

## Heart disease risk factors you can do something about:

✓ Check the ones you have:

- |  |                                   |
|--|-----------------------------------|
| <input type="checkbox"/> Being overweight            | <input type="checkbox"/> Not sure |
| <input type="checkbox"/> High blood pressure         | <input type="checkbox"/> Not sure |
| <input type="checkbox"/> High blood cholesterol      | <input type="checkbox"/> Not sure |
| <input type="checkbox"/> Diabetes                    | <input type="checkbox"/> Not sure |
| <input type="checkbox"/> Not being physically active |                                   |
| <input type="checkbox"/> Cigarette smoking           |                                   |



## Heart disease risk factors you cannot control:

✓ Check the ones that you have:

- Age (45 years or older for men and 55 years or older for women)
- Family history
  - Father or brother with heart disease before age 55
  - Mother or sister with heart disease before age 65

**The more risk factors you have checked, the greater your risk for heart disease. Talk to your doctor about your risk.**

# A Day With the de la Cruz Family

---

People react in different ways when they learn that they must make lifestyle changes to lower their chances of getting heart disease. Let's review how the de la Cruz family acts when they get the news about their risk.



■ **Ric: “I don’t really care.”**

Ric learns that he is at risk for heart disease but he is not concerned. He gets upset when reminded about changing his unhealthy habits. He has no intention of making changes for better health. “Whatever will be, will be,” claims Ric.



■ **Mila: “I am stuck.”**

Mila is worried because she knows that smoking is a risk factor for heart disease, and is aware of the effect that secondhand smoking has on asthma. She thinks about making changes but cannot get started. She feels trapped and is not motivated to take steps for better health. “You can bring a horse to water but you cannot make it drink,” ponders Mila.



■ **Rose: “I am making plans.”**

Rose learns that her husband is at risk for heart disease and thinks that she should make changes. Instead of putting off her efforts until tomorrow, she asks her friends and family for suggestions on how she can make heart healthy changes for her family. “Walking the walk is harder than talking the talk,” says Rose.



■ **Lola (Mrs. Caridad de la Cruz): “I am taking action.”**

Lola learns that she is at risk for heart disease and quickly starts doing something about it. She goes to classes to learn how to improve her health. She practices what she learns. Lola makes simple changes and helps others to do the same. “An ounce of prevention is better than a pound of cure,” says Lola.



■ **Jose: “I stay on the healthy path.”**

Jose is making changes and is motivated to stay on track to improve his health. He knows that it is easy to fall back into old habits. He makes plans to prevent setbacks and learns to start again if he needs to. He is positive toward life. He asks for help and does not give up. “Time is gold and health is priceless,” says Jose.

# A Day With the de la Cruz Family *(continued)*

---

Now, please answer these questions:

1. With which family member do you identify?

---

2. What reasons do you have to make changes for better health?

---

---

3. What are the barriers that keep you from making changes to improve your health?

---

---

4. What can you do to overcome these barriers?

---

---

# Lola's Life Lessons: Session 1

---

One of my favorite proverbs is:

*“Aanhin pa ang damo, kung patay na ang kabayo.”*

Translation: “What good is the grass if the horse is already dead?”

When the doctor told me I had high blood pressure, your Lola was surprised. I do not know of anyone in my family who had high blood pressure, but the doctor said my parents' generation might not have known about all of their health conditions.

When I first came to the United States, I thought I was lucky to be able to afford such good food here. I never thought about whether the foods had too much salt or too much fat. And since living in the United States, I do not walk everywhere like I did in the Philippines. But now, I realize that life is too valuable to overlook these things.

I decided that I have to change my eating and physical activity habits to keep the horse from dying. What good is it if I am here, but unhealthy or suffering? How will I play with my grandchildren and help them become healthy adults? I have learned that knowledge is wealth that cannot be stolen, and I now eat healthy and do physical activity regularly. If I can change my habits at this age, anyone can. It really brings a lifelong reward to yourself and your family.

## **A Time To Reflect...**

What things keep you from making lifestyle changes? What can you do to overcome these things?

(Use this space to write down your thoughts for this week's session.)





# Act in Time to Heart Attack Signs

---

## Objectives

**By the end of this session, group members will learn:**

- What a heart attack is
- Why it is important to seek treatment quickly if a heart attack happens
- The warning signs of a heart attack
- Why people delay seeking help for a heart attack
- The benefits of calling emergency medical services
- How to plan ahead

---

## Materials and Supplies

**To conduct this session, you will need:**

- “Healthy Heart, Healthy Family” manual and picture cards
- “Act in Time to Heart Attack Signs” video
- Blackboard and chalk or several large pieces of paper, markers, and tape
- Videocassette recorder (VCR)/video home system (VHS) and TV monitor



*(Optional) Note:* Arrange for a health professional to come to the session to discuss cardiopulmonary resuscitation (CPR).

---

## **Handouts**

**Give group members these handouts during this session:**

- “Learn What a Heart Attack Feels Like” (page 47)
- “Fast Action Saves Lives” (page 48)
- “Fast Action Saves Lives: Role Plays” (pages 49–51)
- “My Emergency Card” (pages 52–53)
- “Lola’s Life Lessons: Session 2” (page 54)
- “Pledge for Life! Session 2” (page 55)

---

## **Session Outline**

### **Introducing the Session**

1. Welcome
2. Review of Last Week’s Session
3. About This Session

### **Conducting the Session**

1. The Facts Don’t Lie
2. What Is a Heart Attack?
3. Importance of Rapid Treatment for a Heart Attack
4. What Are the Warning Signs of a Heart Attack?
5. Delay Can Be Deadly
6. The Role of Emergency Medical Services
7. How To Plan Ahead

## Review of Today's Key Points

### Lola's Life Lessons: A Time To Reflect

### Pledge for Life!

### Closing

# Introducing the Session

---

## 1. Welcome

- Welcome group members to the session.

## 2. Review of Last Week's Session

- Say:

At the last session, we talked about the risk factors for heart disease.

- Ask:

Who remembers the risk factors that we can prevent or control?



**Note:** Allow about 3 minutes for group members to respond.

- Add the following risk factors if they are not mentioned:

- Overweight and obesity
- Not being physically active
- High blood pressure
- High blood cholesterol
- Diabetes
- Smoking cigarettes

■ **Ask:**

Would any of you like to share what you are doing to improve your heart health?



**Note:** Allow about 2 minutes for group members to respond.

### **3. About This Session**

■ **Say:**

Heart disease develops over many years. Sometimes, despite our best efforts, heart disease can result in a heart attack. That is why it is important to know the warning signs of a heart attack and what to do if you experience them. In today's session, we will discuss the warning signs and the importance of taking quick action if you experience any warning signs. By the end of this session, you will know:

- How the heart functions
- What a heart attack is
- The importance of fast treatment for a heart attack
- The warning signs of a heart attack
- Why people delay seeking help for a heart attack
- The benefits of calling 9–1–1
- Steps you can take now to help you survive a heart attack
- How to prepare your emergency card

■ **Say:**

Lola Idad often says, “*Kung ano ang ginawa mo, ay siya ring babalik sa 'yo,*” which means, “The act of self goes back to self.”

This proverb reminds Lola that the decisions she makes now will affect her later in life.

# Conducting the Session

---

## 1. The Facts Don't Lie

### ■ Say:

- Each year about 1.2 million people in the United States will have a heart attack, and about half of these people will die.
- About half of the people who die of a heart attack will die before they reach the hospital.

### ■ Say:

To begin our session today, I would like to show a video about the importance of paying attention to heart attack warning signs.

### ■ Show “Act in Time to Heart Attack Signs” video (14 minutes).

### ■ Say:

Now that we have seen the video, let's talk about it.

### ■ Ask:

- What did you see in the video?
- What did you hear in the video?
- How did the video make you feel?



**Note:** Allow about 5 minutes for group members to respond.

## 2. What Is a Heart Attack?

### ■ Say:

In the video, you heard facts about heart attacks. Now let's talk about what a heart attack is and how one happens.

■ **Show picture card 2.1.**

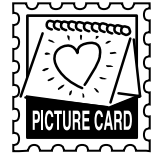

■ **Say:**

A normal artery allows blood to flow freely.

A heart attack occurs when the blood supply going to a portion of the heart through one of the coronary arteries is blocked. Here is how this happens:

- Heart disease, which can lead to a heart attack, develops over time. Fatty deposits build up on the inside of the coronary arteries. When this happens, the arteries become narrow and not enough blood, oxygen, and nutrients get through to meet the needs of the heart.
- The coronary arteries can become blocked, usually by a clot. When this happens, the blood flow is closed off and a heart attack happens.
- If the blockage continues, part of the heart muscle will start to die.

■ **Say:**

- When a heart attack occurs, medical treatment can restore the blood flow to the heart. This keeps the heart muscle from dying.
- Treatments work best if given as soon as possible, within 1 hour after warning signs of a heart attack begin.
- When a part of the heart muscle dies, nothing can be done to restore it.

■ **Ask:**

Are there any questions about what happens during a heart attack?



**Note:** Allow about 5 minutes for group members to respond.

### 3. Importance of Rapid Treatment for a Heart Attack

■ Say:

- Treatments for heart attacks have improved over the years. Twenty years ago, not much could be done to stop a heart attack.
- Today, there are treatments that can open up the heart's arteries and restore blood flow.
- “Clot-busting” medicines and other artery-opening treatments can break up the clots and quickly restore blood flow to the heart.

■ Show picture card 2.2.

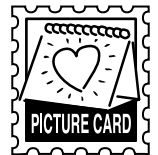

■ Say:

- There is also a treatment called angioplasty. A balloon is placed in the coronary artery and inflated to open the artery. This restores the blood flow.
- Sometimes with angioplasty, doctors will insert a stent. A stent is a wire mesh tube that is used to open the artery.
- The stent stays in the artery and keeps it open to improve blood flow to the heart.

■ Say:

- These treatments should be given as soon as possible, within 1 hour after warning signs of a heart attack start.
- The more heart muscle that is saved, the better chance a heart attack patient has of surviving and returning to a normal life.

### 4. What Are the Warning Signs of a Heart Attack?

■ Say:

It is important to know how to recognize a heart attack. This activity should help you learn the warning signs of a heart attack.



■ **Ask:**

What warning signs would make you think someone was having a heart attack?



**Note:** Write group members' responses on a blackboard or on a large piece of paper taped to the wall.

■ **Give** each group member the “Learn What a Heart Attack Feels Like” handout (page 47).



■ **Show picture card 2.3**, and review the handout.

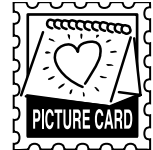

■ **Say:**

These are the warning signs most commonly reported by heart attack patients, both women and men:

- Discomfort in the center of the chest that lasts more than a few minutes—it can feel like uncomfortable pressure, squeezing, fullness, or pain.
- Discomfort in one or both arms or the back, neck, jaw, or stomach
- Shortness of breath, with or without chest discomfort
- Cold sweat
- Feeling light-headed
- Nausea or feeling sick to their stomach

■ **Say:**

One myth about heart attack is that it only happens to men and not women. This is not true—heart attacks occur in both men and women. The most common heart attack warning sign for men and women is chest pain or discomfort.

The warning signs mentioned are the most common ones, and most people experience more than one of them. Some signs occur together. For example, chest discomfort often occurs with shortness of breath. Also, arm pain, sweating, and nausea may occur together.

## ■ Say:

Many people think that all heart attacks happen the way you see in soap operas or in the movies—a person has crushing chest pain and falls to the floor. This is also a myth. The reality is that not all heart attacks happen this way. Many heart attacks start slowly, with signs gradually getting stronger.

- A heart attack is not always a sudden, deadly event. A variety of warning signs may signal that someone is in danger.
- Sometimes the pain or discomfort is mild, and the signs may come and go.

## ■ Ask:

What do you think are other reasons people do not recognize that they are having a heart attack?



**Note:** Allow about 5 minutes for group members to call out answers.

## ■ Add the following reasons if they are not mentioned:

- People may confuse the warning signs of a heart attack with the symptoms of other diseases or illnesses, such as asthma or flu.
- People may confuse heart attack signs with symptoms of a pulled muscle or indigestion.
- Some people do not believe they are at risk for having a heart attack. When they have warning signs, they ignore them or wait to see if the signs get worse before they call for help.

## 5. Delay Can Be Deadly

### ■ Say:

People often wait too long before they seek medical care for the warning signs of a heart attack.

- Some people wait 2 to 4 hours, or even a day or more, before getting help.
- If you think a heart attack is happening, the most important thing to remember is this: Call 9–1–1 in 5 minutes or less.

■ **Say:**

When people having heart attacks decide to seek help, they often do not call 9–1–1. Only half of all heart attack patients arrive at the hospital by ambulance.

- **Give** each group member the “Fast Action Saves Lives” handout (page 48).



■ **Say:**

Let’s go over how to take fast action when you think a heart attack is happening.

- **Ask** a volunteer to read the handout aloud.

■ **Ask:**

Think about yourself and your family—what might prevent you from calling 9–1–1 quickly if you think you are having a heart attack?



**Note:** Allow about 5 minutes for group members to respond. **Write** their answers on the blackboard or on a large piece of paper taped to the wall.

- **Add** these reasons if they are not mentioned:

- They did not think their symptoms were severe enough.
- They were unaware that calling 9–1–1 has many lifesaving advantages.
- They thought driving themselves to the hospital would be faster.
- They were concerned about being embarrassed when an emergency vehicle—ambulance or fire engine—showed up at their door.
- They were concerned about the cost of the ambulance and medical care.
- They were afraid of being embarrassed if the symptoms were a false alarm.

■ **Say:**

If you are having a heart attack, and you or someone else cannot call 9–1–1, have someone drive you to the hospital at once. Never drive yourself. You may pass out along the way, putting yourself and others in danger.

■ **Say:**

It is easy to talk about what to do when a heart attack happens, but it is not so easy to take the right action if you or someone you know is actually having symptoms.

■ **Say:**

Lola Idad has taken steps to educate her family and friends on the importance of calling 9–1–1. Let’s take a look at some of the situations that Lola and her family have encountered over the years. We will act out different scenarios to prepare you for a real situation.



**Note:** **Ask** for volunteers in the group to form three teams of two people each. **Give** each team one of the three different role plays in the “Fast Action Saves Lives: Role Plays” handout (pages 49–51).



**Note:** **Ask** the teams to take a few minutes to read the role play, decide who will play the characters, and think about what they will say. Then **ask** each team to present their “drama” to the group.

■ **Ask:**

Now that you have seen the three scenarios, what do you think is the **main action** you must take when someone is having the warning signs of a heart attack?



**Note:** Allow a moment for group members to call out the answer. If no one gives the correct answer, **say:**

The answer is to call 9–1–1 in 5 minutes or less.

## 6. The Role of Emergency Medical Services

■ **Say:**

Our actors did a great job of showing us why it is important to call 9–1–1 right away. Calling 9–1–1 is like bringing the hospital emergency department to your door.

■ **Ask:**

What are the benefits of calling emergency medical services?



**Note:** Allow 3 minutes for group members to respond.

■ **Add** these answers if they are not mentioned:

- Emergency personnel arrive fast and can start treatment right away. They may carry oxygen, heart medicine, pain relief medicine, aspirin, or other medications that can help in case of a heart attack.
- In many locations, emergency personnel are linked to the hospital. They can send information about a patient's condition to the emergency department before the patient arrives at the hospital.
- Heart attack patients who are brought by ambulance receive faster treatment than patients who have someone drive them to the hospital.
- Your heart may stop beating during a heart attack. Emergency personnel carry equipment to restart the heart if that happens.



**Note:** Most communities have the 9–1–1 system. However, if your community does not, **say:**

The best way to get the care you need is to call the local emergency medical number. In our community, that number is \_\_\_\_\_.

■ **Say:**

It is a good idea to plan ahead for who will take care of your family in an emergency. Emergency personnel will usually contact a relative or friend to make arrangements, if necessary.

■ **Ask:**

What would you plan to do if you suddenly had to go to the hospital in an ambulance?



**Note:** Allow about 5 minutes for group members to discuss their answers.

## 7. How To Plan Ahead

### ■ Say:

We have learned a lot today about heart attacks and what to do if one happens. Here's the good news: Planning ahead with your family can help you survive a heart attack. Here are things you can do now to prepare for a possible heart attack.

### ■ Show picture card 2.4.

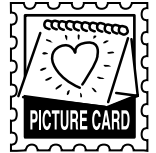

### ■ Say:

You now know the warning signs of a heart attack. Talk to your family and friends about these signs and the importance of calling 9–1–1 right away.

### ■ Show picture card 2.5.

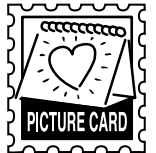

### ■ Say:

You and other adults in your family should talk to your doctor about your risk of a heart attack and how to lower it.

### ■ Show picture card 2.6, and give each group member the “My Emergency Card” handout (pages 52–53).

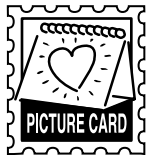

### ■ Say:

You and your family should have a plan of action in case of an emergency. This plan should include an emergency card. This card gives health care providers the information they need to know about you in case of an emergency.

Let's look at the emergency card. The emergency card includes the following information:

- Name, relationship, and phone number of emergency contacts who should be called if you have to go to the hospital
- Emergency numbers in your area
- Your health conditions
- Current medicines

- Known allergies
- Name and phone number of your doctor or clinic
- Any other important information

Make copies for all adults in your family and encourage them to fill them out.

- **Ask** for volunteers to tell you how they would explain to their family members the importance of making a survival plan.
- **Ask** group members to tell you how they would make sure that all of their family members (such as a grandparent, spouse, or uncle) know what to do in case of a heart attack.



**Note:** Allow 2 or 3 minutes for group members to respond.

### More Information

#### **Aspirin: Take With Caution**

A person who is thinking about using aspirin to treat or prevent heart problems should talk to a doctor first. If the doctor thinks that aspirin is a good choice, it is important to take the correct dose.

If a person has had a heart attack or stroke, aspirin can help lower the risk of a second one. It can also help keep arteries open in persons who have had heart surgery. It has also been shown that healthy women who take a low dose of aspirin every other day may prevent a first stroke. Aspirin may also prevent a first heart attack in women over the age of 65.

# Review of Today's Key Points

---

## ■ Say:

Let's review the main points that we learned today.

### **What is a heart attack?**

- A heart attack occurs when a coronary artery becomes blocked and blood flow is closed off.
- If the blood flow is stopped, parts of the heart muscle start to die.

### **What stops a heart attack?**

- Quick action and medical treatment restore blood flow and save heart muscle.

### **Why is it important to get treatment quickly?**

- Quick treatment can prevent the heart muscle from dying.
- It is best to receive treatment within 1 hour after warning signs start. This will improve chances of survival and will help save the heart muscle.
- “Clot-busting” and other medicines open up the artery and restore blood flow.
- Angioplasty opens the artery and restores blood flow.

### **What are the warning signs of a heart attack?**

- Your chest may hurt or feel squeezed.
- One or both of your arms, your back, or your stomach may hurt.
- You may feel pain in your neck or jaw.
- You may feel like you cannot breathe.
- You may feel light-headed or break out in a cold sweat.
- You may feel sick to your stomach.



## What should you do if you experience these warning signs?

- Call 9–1–1 in 5 minutes or less, even if you are not sure you are having a heart attack. Calling 9–1–1 gets you treated more quickly.
- Do not drive yourself to the hospital.

## Lola’s Life Lessons: A Time To Reflect

### ■ Say:

In the last session, Lola Idad reminded us that honesty and determination will help you make changes to prevent risk factors for heart disease.

### ■ Say:

Let’s see how Lola and the family have learned the signs of a heart attack and how important it is to call 9–1–1 immediately.

- **Give** each group member the “Lola’s Life Lessons: Session 2” handout (page 54). **Ask** a volunteer to read the handout.



### ■ Say:

Please take a few moments to reflect on Lola’s advice and how it applies to your life. At the bottom of the handout, there is a space called “A Time To Reflect.” Use this section to record your feelings about this week’s session. Please write down your thoughts. Remember, this is for you and no one else.

- **Give** group members 2 to 3 minutes to write down their thoughts.

# Pledge for Life!



■ **Say:**

You have learned a lot today about how to be prepared if a heart attack happens. Now let's think about how you can practice what you have learned. Please think of one change you can make. This will be your pledge for the week.

- **Give** each group member the “Pledge for Life! Session 2” handout (page 55).



■ **Say:**

Take the pledge for life with Lola Idad and try to do one thing this week to be prepared if a heart attack happens. Be specific about what you plan to do, how you plan to do it, and when you will start. Here are some examples:

- Within the next week, I will think about what to do if a heart attack happens at home, at work, in the middle of the night, or in other situations.
- I will talk with family and friends within the next week about the heart attack warning signs and the need to call 9–1–1 right away.
- I will set up an appointment within the next month to talk to my doctor about my heart attack risk.



**Note:** Allow 5 minutes for group members to think of a pledge.

■ **Say:**

Would anyone like to share his or her pledge with the group?



**Note:** Write down pledge ideas on the blackboard or on a large piece of paper taped to the wall.

# Closing

---

■ **Say:**

Thank you for coming today. What did you think of today's session?



**Note:** Allow a moment for group members to respond.

■ **Say:**

The next session is about physical activity. Please wear comfortable clothing and walking shoes.



**Note for Educator:** Think about today's class. What worked? What didn't work? Do you think the session helped group members learn the warning signs for a heart attack and to call 9-1-1 immediately?

# Learn What a Heart Attack Feels Like

**Act fast. Call 9-1-1.  
It could save your life.**

Clot-busting medicines and other treatments can stop a heart attack as it is happening. **These treatments work best if given within 1 hour of when heart attack signs begin.**

If you think you are having a heart attack, call 9-1-1 right away.

## **KNOW THE HEART ATTACK WARNING SIGNS:**

Your chest may feel pressure.



You may feel discomfort in one or both arms, or the back or stomach.



You may feel discomfort in your neck or jaw.



You may feel like you can't breathe.



You may feel light-headed or break out in a cold sweat.



You may feel sick to your stomach.

# Fast Action Saves Lives

## **YOU MAY NOT BE SURE IT IS A HEART ATTACK.**

A heart attack may not be sudden or very painful. You may not be sure what is wrong.  
**But it is important to check it out right away.**



## **ACT FAST. CALL 9-1-1.**

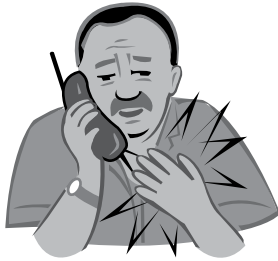

Call 9-1-1 in 5 minutes or less.  
Do not drive yourself to the hospital.



When you call 9-1-1, an emergency vehicle arrives  
right away. Medicines can be given at once.

## **TO HELP SURVIVE A HEART ATTACK, TAKE THESE STEPS:**

- Learn warning signs of a heart attack, and act fast if you feel them.
- Talk with family and friends about the warning signs and the need to call 9-1-1 right away.
- Ask your doctor about your heart attack risk and how to lower it.
- Complete the “My Emergency Card” handout.

# Fast Action Saves Lives: Role Plays

---

## Role Play 1: At Home

Lola Idad is at home. Lola lives with her daughter, Mila. Lola and her longtime friend, Ligaya, are chatting over their midday snack (*merienda*) at the kitchen table.

**Ligaya:** Idad, I am not feeling my best today. My arm hurts a little and it feels uncomfortable here. I feel a little light-headed.

**Lola:** You do not look well. I went to that meeting at the community center. Dr. Cabaya talked about what to do if you or someone else has signs of a heart attack. He stressed that the first thing we should do is call 9-1-1.

**Ligaya:** Oh, I am sure it's not anything serious. Maybe it's my ulcer acting up again. I have been worried about my sister lately. Never mind, I'm sure I am fine. Are we going to play mahjong tonight?

**Lola:** No! You have some of the signs of a heart attack. Dr. Cabaya said that even if you are not sure it's a heart attack, have it checked out immediately. Mila! Call 9-1-1 immediately while I stay with Ligaya. She needs an ambulance!

**Mila, Lola's daughter, enters the room panicked and calls 9-1-1.**

**Lola:** *Kumare* (friend), if it is a heart attack, fast medical treatment can prevent damage to the heart. Getting to the hospital quickly means that you can be treated right away. Calling 9-1-1 may save your life!

# Fast Action Saves Lives: Role Plays *(continued)*

---

## Role Play 2: At Work

Lola's son-in-law, Cesar, is at work one afternoon and sees that his coworker Rolando does not look well.

**Cesar:** Rolando, are you okay?

**Rolando:** I haven't been feeling well all morning. My stomach feels queasy and I feel light-headed. I don't think it's anything serious. Maybe it is just my morning breakfast—a little indigestion.

**Cesar:** Are you sure? You don't look good.

**Rolando:** It's okay. But my chest does feel heavy, and I have shortness of breath.

**Cesar:** You know, Rolando, those are signs of a heart attack. It is best to go to the hospital and get it checked out. I am going to call 9–1–1 right now!

**Rolando:** Cesar, how could I be having a heart attack? I am not even 50 yet! I'm still slim and I do physical activity regularly. I walk a lot. You are overreacting. If I still feel like this tomorrow, I will call my doctor for an appointment.

**Cesar:** Rolando, even if you are not 100 percent sure it's a heart attack, you should check it out immediately. If it is a heart attack, fast medical treatment can prevent damage to your heart. Getting to the hospital quickly could save your life! I am calling 9–1–1 now.

# Fast Action Saves Lives: Role Plays *(continued)*

---

## Role Play 3: At Night

Lola's daughter, Mila, is home reading a magazine when she suddenly starts to feel very sick. No one else is home, so she telephones her brother, Jose, who is a nurse. He is not home.

**Mila:** Hi, Rose, is Jose there?

**Rose:** No, he is out bowling tonight. What's wrong, *Ate*?\* You sound upset.

**Mila:** Cesar took Mama (Lola) to the market, and I'm worried because I do not feel well. My neck hurts, and I have been in a cold sweat. And it is hard for me to breathe. I think I should drive myself to the hospital. Can you watch the kids while I go to the hospital?

**Rose:** *Ate* Mila, it sounds like you are having a heart attack. Do not drive yourself to the hospital. Call 9-1-1 right now! The medical team will treat you and get you to the hospital quickly.

**Mila:** No, I do not want to wake up the neighborhood and cause a big scene with the siren and lights. Also, I do not want to scare the kids. It is easier to drive myself to the hospital.

**Rose:** *Ate*, no! Call 9-1-1 right now! Once the ambulance comes, the medical team can start medical care immediately. And people who arrive by ambulance tend to get faster treatment when they get to the hospital.

You may not think you are having a heart attack because you've never had one before, but your symptoms sound like those of a heart attack. Call 9-1-1 right now. I am coming over.

**Mila:** Okay, Rose. I will call. Thank you.

\* *Ate* refers to an elder sister.



# My Emergency Card

Cut along dotted lines. Fold card in half and paste with a glue stick (Fold 1).  
Fold in half again to make your own personal wallet card (Fold 2).

Family Doctor: \_\_\_\_\_  
 Phone: \_\_\_\_\_  
 Local Clinic/Hospital: \_\_\_\_\_  
 Phone: \_\_\_\_\_

**Emergency Numbers**

Fire Department: \_\_\_\_\_  
 Local Police Department: \_\_\_\_\_

## My Emergency Card

Name: \_\_\_\_\_  
 Date of Birth: \_\_\_\_\_ Home Phone: \_\_\_\_\_

Emergency Contacts:

Name	Relationship	Phone

**Do you have any of the following conditions?**

Heart Disease \_\_\_\_\_  Yes  No  
 Previous Heart Attack \_\_\_\_\_  Yes  No  
 High Blood Pressure \_\_\_\_\_  Yes  No  
 Diabetes \_\_\_\_\_  Yes  No  
 Other \_\_\_\_\_  Yes  No

Current Medications: \_\_\_\_\_  
 Known Allergies: \_\_\_\_\_  
 Other Information: \_\_\_\_\_  
 \_\_\_\_\_  
 \_\_\_\_\_

(Fold 1)

# Aking Card na Pangkagipitan

*Gupitin sa tuldok-tuldok na mga linya. Iupit sa kalahati ang card at idikit gamit ang isang glue stick (1 Tupi). Muling tupiin sa kalahati upang magawa ang iyong sariling pampersonal na card na pang-wallet (2 Tupi).*

(2 tupi)

## Aking Card na Pangkagipitan

Pangalan: \_\_\_\_\_  
 Kapanganakan: \_\_\_\_\_ Telepono sa Bahay: \_\_\_\_\_

Mga Contact na Pangkagipitan:

Pangalan	Kaugnayan	Telepono

Duktor ng Pamilya: \_\_\_\_\_  
 Telepono: \_\_\_\_\_  
 Panlokal na Klinika/Ospital: \_\_\_\_\_  
 Telepono: \_\_\_\_\_

### Mga Nunerong Pangkagipitan

Fire Department: \_\_\_\_\_

(1 tupi)

**Nayroon ka ba ng anumang mga sumusunod na kundisyon?**

Sakit sa puso  Oo  Hindi  
 Atake sa Puso Kamakailan  Oo  Hindi  
 Mataas na presyon ng dugo  Oo  Hindi  
 Diyabetis  Oo  Hindi  
 Iba pa \_\_\_\_\_

Mga kasalukuyang Paggagamot: \_\_\_\_\_  
 Mga Alam na Allergy: \_\_\_\_\_  
 Other Information: \_\_\_\_\_  
 \_\_\_\_\_  
 \_\_\_\_\_

# Lola's Life Lessons: Session 2

---

One of my favorite proverbs is:

*“Kung ano ang ginawa mo, ay siya ring babalik sa’yo.”*

Translation: The act of self goes back to self.

My *tatay* (father) used to say this proverb all the time. He believed that the choices we made early on in life would affect our future. Making the best choices may not be the easiest path to take, but we have the power to move our lives in the right direction. Last year, my youngest son in Manila had a heart attack. The hospital said we were lucky that Santiago’s friends called the ambulance right away.

I was shocked when I heard the news. The only thing I ever wanted in life was for my family to be safe and healthy. I felt it was my fault, and maybe I should have taken better care of him when he was younger. But the doctor told us that there are some things we cannot control and others that we can control.

So, our family made changes to those things that we can control, like being prepared in case of an emergency. We learned the heart attack signs, and we keep all of our emergency cards by the phone. The entire de la Cruz family—even the children—knows that calling 9–1–1 immediately can save a life. Always remember, “the act of self goes back to self.”

## **A Time To Reflect...**

Think about your daily routine. What choices have you made to lower your risk and your family’s risk of a heart attack? What are some new choices that can help you and your family act in time to heart attack signs?

(Use this space to write down your thoughts for this week’s session.)

# Pledge for Life! Session 2

---

Take the pledge for life with Lola Idad. Try to do at least one of these activities by yourself, with family, and/or share the activities with others.

- Learn the heart attack warning signs.
- Talk with family and friends about the warning signs and the need to call 9–1–1 in less than 5 minutes.
- Remind your family and friends that it is better to be cautious and call 9–1–1 than be embarrassed about a false alarm.
- Talk to your doctor about your heart attack risk.
- Share your emergency card with other family members and/or friends.
- Encourage family members and friends to have their own plans and emergency cards.
- Remind your family and friends that both men and women are vulnerable to heart attack.
- Check your blood pressure and cholesterol levels regularly.
- Try to learn about your family’s history regarding risk factors associated with heart disease and cause of death.
- Other \_\_\_\_\_



# Get Energized! Say YES to Physical Activity

---

## Objectives

**By the end of this session, group members will learn that:**

- Physical activity is good for the heart and overall health.
  - Adults should be physically active for 30 to 60 minutes on most days.
  - Children and adolescents should be physically active for about 60 minutes on most days, preferably daily.
  - Brisk walking is a simple activity that nearly everyone can do.
  - There are ways to fit more activity into a busy schedule.
- 

## Materials and Supplies

**To conduct this session, you will need:**

- “Healthy Heart, Healthy Family” manual and picture cards
  - Blackboard and chalk or several large pieces of paper, a marker, and tape
  - *(Optional)* Index cards for physical activity guessing game\*
  - *(Optional)* Videocassette recorder (VCR)/video home system (VHS) or DVD and television
- 

\* Prepare before the session.

- Cool drinking water and cups
  - *(Optional)* Music for walking activity and tape or CD player
- 

## **Handouts**

### **Give group members these handouts during this session:**

- “Role Play: Mila and Cesar Dance Their Way to Heart Health” (page 80)
  - “Getting Started With Physical Activity” (page 81)
  - “Getting Started With Physical Activity: Lola Idad’s Answers” (page 82)
  - “Take Heart—Say Yes to Physical Activity” (pages 83–84)
  - “Lola’s Tips for Staying Motivated” (page 85)
  - “Stretching Activities” (pages 86–88)
  - “Tips on Physical Activity” (page 89)
  - “Make Physical Activity Part of Your Life—My Personal Record” (pages 90–91)
  - “Sample Walking Program” (page 92)
  - “Lola’s Life Lessons: Session 3” (page 93)
  - “Pledge for Life! Session 3” (page 94)
- 

## **Session Outline**

### **Introducing the Session**

1. Welcome
2. Review of Last Week’s Session
3. About This Session

## Conducting the Session

1. Facts About Physical Activity
2. Benefits of Physical Activity
3. Types of Physical Activity
4. *(Optional)* Physical Activity Guessing Game
5. Getting Started: Important Things To Know
6. Finding Time To Be Physically Active
7. Walking: An Activity for Almost Everyone\*
  - A. Discussion and Stretching
  - B. Walking Activity

## Review of Today's Key Points

## Lola's Life Lessons: A Time To Reflect

## Pledge for Life! Session 3

## Closing



**Note:** If you have time, include a 30-minute activity, such as walking, at the beginning or end of each of the remaining sessions.

---

\* Prepare for the walking activity by reading the “Tips for Preparing for the Walking Activity” box on page 73.



# Introducing the Session

---

## 1. Welcome

- Welcome group members to the session.

## 2. Review of Last Week's Session

- Say:

At the last session we talked about the heart attack warning signs. Who remembers the warning signs of a heart attack?



**Note:** Allow about 3 minutes for group members to respond. **Write** their answers on the blackboard or on a large piece of paper taped to the wall.

- **Add** these signs if they are not mentioned:

- Your chest may hurt or feel squeezed.
- You may feel pain in your neck or jaw.
- One or both of your arms, your back, or your stomach may hurt.
- You may feel like you can't breathe.
- You may break out in a cold sweat.
- You may feel sick to your stomach.
- You may feel light-headed.

- **Ask:**

Who remembers what you should do if you feel these symptoms?



**Note:** Allow 3 minutes for group members to respond.

■ **Say:**

The answers are:

- Call 9–1–1 in 5 minutes or less, even if you are not sure you are having a heart attack. Calling 9–1–1 gets you treated more quickly.
- Do not drive yourself to the hospital.

■ **Say:**

At the end of the session, we pledged to do one thing to be prepared if a heart attack happens. Please share with the group what you did.



**Note:** Allow 2 to 3 minutes for group members to respond.

### **3. About This Session**

■ **Say:**

During today’s session, we will discuss physical activity and how important it is to your heart health. When the session ends, you will know:

- How physical activity can help you and your family
- What kinds of activities are good for you and for your heart
- How much activity you should do
- How you can find time to be physically active



**Note:** “Physical activity” and “exercise” mean the same thing.

■ **Say:**

- Physical activity keeps you strong and healthy, both physically and mentally.
- Sometimes, it may seem hard to find the time for regular physical activity. In the beginning, you may not look forward to it. Lola Idad has found a number of ways to build physical activity into her daily lifestyle and enjoy it.

- Lola likes to say, “Walang mahirap na gawa pag dinaan sa tiyaga,” which means, “No undertaking is difficult if pursued with perseverance.”
- Lola now knows the value of including physical activity in her and her family’s daily routines.

## Conducting the Session

### 1. Facts About Physical Activity

#### ■ Say:

Not getting enough physical activity is a major health risk for people today.

- Not being physically active puts you at risk for heart disease. The good news is that you can do something about this risk factor.
- Approximately one-third of Asians in the United States takes part in regular physical activity.
- Filipino residents in the state of Hawaii do less physical activity compared to the other Asian and Native Hawaiian residents.
- In the Philippines, approximately 15 percent of Filipinos participate regularly in vigorous physical activity.
- In the Philippines, less than 8 percent of students aged 13 to 15 years old are physically active for at least 60 minutes per day.
- As a person gets older, having little or no physical activity can lead to health problems.

### 2. Benefits of Physical Activity

#### ■ Ask:

How do you think physical activity can help you?



**Note:** Allow about 5 minutes for group members to respond. **Write** their answers on the blackboard or on a large piece of paper taped to the wall.

■ **Show picture card 3.1.**

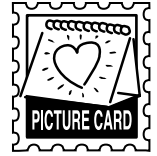

■ **Say:**

Physical activity can help you:

- Strengthen your heart and lungs.
- Build and maintain healthy bones, muscles, and joints.
- Control your weight.
- Have more energy.
- Feel better about yourself.
- Lower your stress.
- Reduce feelings of depression and anxiety.
- Sleep better.

■ **Show picture card 3.2.**

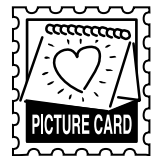

■ **Say:**

Physical activity can also help you:

- Lower your blood pressure.
- Control your blood cholesterol.
- Lower your risk of getting heart disease, diabetes, and some types of cancer.

■ **Show picture card 3.3.**

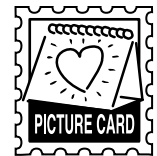

■ **Say:**

People feel better when they are active. Physical activity may help you maintain a healthy weight or lose weight if you are overweight.

■ **Say:**

Let's look at how Mila and Cesar found a physical activity group that fit their schedule and that they enjoy.



**Note:** Ask for three volunteers to act out the role play, “Mila and Cesar Dance Their Way to Heart Health” handout (page 80). **Give** the three volunteers a copy. As the trainer, you can **read** the introduction.

### 3. Types of Physical Activity

■ **Ask:**

What do you do to be physically active?



**Note:** Allow about 5 minutes for group members to respond. **Write** their answers on the blackboard or on a large piece of paper taped to the wall.

■ **Say:**

There are different types of physical activity. Physical activity includes some of the things that you probably do each day, like walking, climbing stairs, or doing household chores.

■ **Show picture card 3.4.**

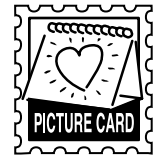

■ **Say:**

You may want to start with **moderate** (medium-level) activities. Moderate activities should require you to make some physical effort, but you should be able to have a conversation comfortably while doing them. **Examples of moderate activities include:**

- Walking at a brisk pace
- Gardening (mowing, raking)
- Dancing (ballroom, line, or folk dancing)
- Making home repairs (painting)
- Washing and waxing a car
- Scrubbing floors and washing windows
- Weightlifting
- Practicing tai chi or yoga
- Playing stickball or softball
- Bowling
- Doing floor exercises (pushups, situps)
- Playing with a hula hoop
- Doing chair exercises (for seniors or persons with disabilities)

■ **Show picture card 3.5.**

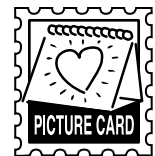

## ■ Say:

After a while, you will be able to do more **vigorous** (high-level) activities. Vigorous activities require hard physical effort and make your heart rate and breathing much faster. You usually cannot carry on a conversation comfortably while you are doing vigorous activities. **Vigorous activities that you might enjoy include:**

- Playing basketball, baseball, or kickball
- Playing tennis
- Running or jogging
- Bicycling fast or uphill
- Doing aerobics or floor exercises (calisthenics)
- Swimming laps
- Practicing martial arts (arnis, dumog/harimaw buno, karate)
- Jumping rope
- Roller skating
- Performing heavy construction work

## 4. (Optional) Physical Activity Guessing Game



**Note:** You can play a physical activity guessing game. Ahead of time, **write** the names of the 8 medium-level physical activities on index cards of one color and the 10 high-level activities on index cards of a different color (listed on page 84).

- **Divide** participants into two groups, and **give** each person a card.
- **Ask** the medium-level activity group to go first. One by one, each person will act out the physical activity on his or her card. **Ask** the rest of the participants to guess the activity.

Follow the same process for the high-level activity group.

## ■ Say:

All types of physical activity are good for you. Aerobic activities, such as brisk walking that speeds your heart rate and breathing, help your heart. Other activities, such as weightlifting and stretching, can help improve strength and flexibility.

■ **Say:**

Start slowly. Then move on to higher-level activities. For example, when you are comfortable walking, gradually begin to jog. You will feel great!

■ **Ask:**

How much physical activity do you think you need to do each day to improve your health?



**Note:** Allow 1 to 3 minutes for group members to answer.

■ **Say:**

- Adults should have at least 30 minutes of moderate physical activity on most days, preferably every day, to lower their chances of getting heart disease.
- Some adults need up to 60 minutes of moderate physical activity on most days to prevent unhealthy weight gain.
- Adults who used to be overweight need 60 to 90 minutes of moderate physical activity every day to avoid regaining weight.
- Children and adolescents need at least 60 minutes of moderate to vigorous physical activity on most days, preferably daily.

■ **Show picture card 3.6.**

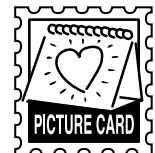

■ **Say:**

If you cannot set aside 30 to 60 minutes at one time to be active, you can break your activity into shorter periods of 10 minutes or longer. It is the total time of physical activity that is important. Just make sure that the total time adds up to 30 to 60 minutes on most days.

■ **Say:**

For example, if you can only do 30 minutes of physical activity a day:

- Practice tai chi or yoga for 10 minutes before you go to work ..... 10
  - Take a 10-minute walk with your kids after work ..... +10
  - Practice dancing for 10 minutes later in the day ..... +10
- 
- 30 minutes

■ **Show picture card 3.7.**

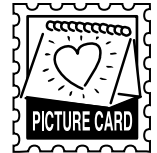

■ **Say:**

If you have more time, you can build up to 60 minutes a day with activities like these:

- Practice tai chi or yoga for 10 minutes before you go to work ..... 10
  - Take a 15-minute walk with coworkers during your lunch break ..... 15
  - Walk the dog after dinner ..... 10
  - Do housework for 15 minutes (carry out trash bags, vacuum floors, put away groceries, scrub the bathtub) ..... 15
  - Practice dancing for 10 minutes later in the day ..... +10
- 
- 60 minutes

■ **Ask:**

Add it up: Do you get 30 to 60 minutes of physical activity during your workday?

- If so, that's great!
- If not, start to do more physical activity to improve your heart health today!



## More Information

### Just Move It

- Physical activity is important in weight control.
- Try to be physically active for 30 to 60 minutes on most days.

**Here are some examples of how many calories you can burn from various activities for 30 minutes.**

<b>Activity</b>	<b>Calories burned per 30 minutes*</b>
Weightlifting	110
Walking (briskly), 3½ miles per hour	140
Gardening	165
Raking leaves	165
Dancing	240
Bicycling (slowly), 10 miles per hour	145
Playing basketball	220
Jogging, 5 miles per hour	295

\*For a healthy 154-pound person. A lighter person burns fewer calories; a heavier person burns more.

Source: "The Compendium of Physical Activities Tracking Guide," University of South Carolina, 2002.

## 5. Getting Started: Important Things To Know



**Note:** This session provides information for people who are just starting to be active. It also helps people add more activity to what they already do.

■ **Say:**

There are a few things you should know before starting to be physically active.

- **Give** each group member the “Getting Started With Physical Activity” handout (page 81).



■ **Say:**

It’s very important to know when to talk with a doctor before starting a physical activity program. In the list on your handout, check which people should see a doctor before they begin physical activity.

**Read** the passages below while the group members check off the boxes.

- Manuel is 65 years old and had a heart attack 10 years ago, but he is fully recovered.
- Valentina is 32 years old and had a healthy baby 8 months ago.
- Francisco is 38 years old and has diabetes, but he controls his condition very well with medication.
- Roselle is 35 years old and wants to start being more physically active to lower her high blood pressure and help herself to quit smoking.
- Bella is 27 years old and in good health, and she wants to start running.
- Roberto is 57 years old and broke his leg 2 years ago, but it healed very well. He walks every day but wants to start jogging.



**Note:** Allow a few minutes for group members to discuss.

- **Give** each group member the “Getting Started With Physical Activity: Lola Idad’s Answers” handout (page 82).



■ **Say:**

Let's look at the handout to see what Lola Idad has to say about this.



**Note:** Go over the answers with the group.

■ **Say:**

These are Lola Idad's answers:

- Manuel **should** see a doctor before starting a physical activity program, because he has had a heart attack. Even though he is fully recovered, he should still check with his doctor.
- Valentina **does not need** to see a doctor before starting a physical activity program. Having a baby is not a risk factor, and she is young.
- Francisco **should** see a doctor before starting a physical activity program, because he has diabetes. Even though he is young and he controls his condition very well with medication, he should still check with his doctor.
- Roselle **should** see a doctor before starting a physical activity program, because she has two risk factors: high blood pressure and smoking.
- Bella **does not need** to see a doctor before starting a physical activity program. Even though she wants to start a harder activity, such as running, she is young (under 50 years old) and in good health.
- Roberto **should** see a doctor before starting a physical activity program. His broken leg is not a factor, but he should check with the doctor first, because he wants to start a harder physical activity program, and he is more than 45 years old.

■ **Say:**

Here are some other things you should know before starting a physical activity program:

1. Start slowly. Build up the time and effort that you put into any activity. You should not be tired the next day.

2. Drink plenty of fluids before, during, and after physical activity, even if you are not thirsty. Drink water. Water has no calories and will prevent you from becoming dehydrated. Special sports drinks are not needed.
3. Wear shoes and socks that give your feet support. Shoes with thick soles will cushion your feet and absorb shock.
4. Wear comfortable clothing. You do not need to buy fancy outfits.
5. **Never** wrap your body in plastic or wear clothing that is too heavy. This will not help you lose fat, but it can:
  - Make you sweat too much.
  - Make your body temperature rise.
  - Make your heart beat too fast.
  - Make you sick to your stomach.
  - Cause you to pass out.
  - Cause damage to your organs.

■ **Ask:**

Does anyone have any questions?



**Note:** Give the group 2 to 3 minutes to ask questions.

■ **Say:**

You should also know that some people who are very overweight may face special challenges in trying to be physically active, but they, too, have good options.

Start with these activities:

- Weight-bearing activities, such as walking, involve lifting or pushing your own body weight.

- Nonweight-bearing activities, such as swimming and water workouts, put less stress on your joints because you do not have to lift or push your own weight. If your feet or joints hurt when you stand, nonweight-bearing activities may be best for you.
- Lifestyle activities, such as gardening, do not have to be planned.



**Note:** For more information on being active at any size, visit the Weight-control Information Network at <http://win.niddk.nih.gov/publications/active.htm>, or call 1-800-946-4627 (toll free).

■ **Ask:**

Does anyone have any questions?



**Note:** Give the group 2 to 3 minutes to ask questions.

## 6. Finding Time To Be Physically Active

■ **Say:**

I know that all of you have busy lives. You may be wondering how you will ever find time to be physically active. Let's look at some ways.

- **Give** each group member the “Take Heart—Say Yes to Physical Activity” handout (pages 83–84). **Read** the handout aloud.



■ **Ask:**

What are some other ways to become more active even when you don't have much time?



**Note:** Allow about 5 minutes for group members to answer. **Write** their answers on the blackboard or on a large piece of paper taped to the wall.

- **Add** these ways if group members do not mention them.

- Take a 15- to 20-minute walk during your lunch break at work or after dinner with your family.
- Jump rope a few minutes each day. Work up to jumping for 10 minutes.
- Dance with your children. You'll burn calories and have fun together.

■ **Say:**

Spend more time being active and cut down on watching TV and movies, using the computer, and playing video games.

- **Give** each group member the “Lola’s Tips for Staying Motivated” handout.



## 7. Walking: An Activity for Almost Everyone

### Tips for Preparing for the Walking Activity

#### Before the start of this session:

- **Review** the “Stretching Activities” handout (pages 86–88).
- **Practice** until you know each part well enough to teach it to the group.
- **Practice** a brisk walk. Take long strides, swinging your arms.



#### When leading this activity, remember:

- Music can get people in the mood for being active. Use a lively song for the warmup exercises, a faster beat for the walking, and a relaxing song for the cooldown period. Make sure that no one objects to the music.
- Be enthusiastic. Group members will pick up on your enthusiasm and feel good about exercising.
- Lead the walk in a circle if you have to walk indoors or if space is limited.
- Have plenty of cool drinking water available before and after the activity.

## A. Discussion and Stretching

### ■ Say:

Brisk walking is an excellent form of physical activity. It's easy to do and you do not need special equipment. All you need are shoes for support and socks for cushioning.

### ■ Say:

Walking can be done outdoors or indoors. If you do not feel safe walking in your neighborhood, a school or churchyard may be a safer place to walk. Walk in well-lit areas at night. Many shopping malls let people walk inside the mall before the stores open. Some malls even have walking clubs that meet every day.

### ■ Say:

It's important to spend time warming up and cooling down each time you are physically active. Although the risk of injury from walking is low, the warmup gets your leg muscles ready for the activity. The cooldown lets your heart rate slowly return to normal. This keeps your leg muscles from getting stiff.



**Note:** Ask the group members to stand up and spread out, with at least 3 feet between them and other group members. Then, **start** the music.

### ■ Say:

It is important to warm up your muscles and stretch before you begin physical activity. First, we will warm up our muscles, and then we will stretch. Let's walk in place slowly for 3 minutes.

### ■ Say:

Now, I am going to show you some stretching activities. Watch me, and then try doing them yourselves. Some are easier to do than others. With time and practice, you will be able to do them all. If you have a bit of trouble at first, just do your best. You will receive a handout that tells you how to do these stretching activities. Use the handout to help you do them at home.

## B. Walking Activity



**Note:** After the stretching activities, **lead** the group members on a 15- to 20-minute walk. **Walk** slowly for the first 5 minutes. Then **show** them how to do a brisk walk for 5 to 10 minutes. During the last 5 minutes, **slow** your pace.

### ■ Say:

We are slowing down now so that our bodies can gradually relax. This important part is called the cooldown period. It's usually recommended that you gradually slow your pace during the last 5 minutes of an activity. Doing a few stretching exercises to loosen the muscles should also be part of your cooldown.

### ■ Say:

For example, runners or joggers may cool down by walking for a few minutes and then stretching their leg muscles before they stop entirely.

### ■ Ask:

How do you feel? Do you think you could continue to walk like this? Why or why not?



**Note:** Allow 3 to 5 minutes for group members to respond.

### ■ Say:

If you already walk three or more times a week, add other activities to become more fit. Try jogging, jumping rope, or dancing.

### ■ Say:

One of the hardest parts of being more active is staying motivated. Many people find that having a partner helps them stay active. A partner can be a family member, neighbor, or friend. The benefits of having a partner are:

- You can motivate each other. You can set goals together and help each other meet them.
- It makes the time go by faster. You focus on talking rather than on the activity.



■ **Say:**

Walking clubs are a great way to enjoy physical activity and make friends.



**Note:** See pages 507–509 in the Appendix for tips on how to organize a walking club, so you can share the tips with group members.

■ **Ask:**

- What would help you stay motivated so that you continue being physically active?
- Where are some safe places in your neighborhood to be active?



**Note:** Allow about 3 minutes for group members to answer. **Write** their answers on the blackboard or on a large piece of paper taped to the wall.

- **Give** each group member the following handouts: “Stretching Activities” (pages 86–88), “Tips on Physical Activity” (page 89), “Make Physical Activity Part of Your Life—My Personal Record” (pages 90–91), and “Sample Walking Program” (page 92).



■ **Say:**

Use the “Make Physical Activity Part of Your Life—My Personal Record” handout to track your daily progress.

## Review of Today’s Key Points

---

■ **Say:**

Let’s review what we have learned today.

**What are some of the benefits of regular physical activity?**

Regular physical activity can help:

- Strengthen your heart and lungs.
- Build and maintain healthy bones, muscles, and joints.
- Help you lose excess weight and prevent weight gain.

- Control blood cholesterol and lower blood pressure.
- Help you sleep better, reduce stress, increase energy, and reduce feelings of depression.
- Lower your chances of heart disease, diabetes, and some types of cancer.

**What is an activity that just about everyone can do?**

- Brisk walking

**What are simple ways to become more active throughout the day?**

- Take a walk.
- Get off the bus early and walk.
- Dance to your favorite music.

**What is the minimum amount of physical activity recommended for you to do every day?**

- Adults need at least 30 minutes, and children and adolescents need at least 60 minutes daily.

## Lola’s Life Lessons: A Time To Reflect

■ **Say:**

In the last session, Lola Idad reminded us that reflection can help us make heart healthy choices for the future. Although the choices may be hard, do not give up! If you stay with it, you can make lifestyle changes.

- **Give** each group member the “Lola’s Life Lessons: Session 3” handout (page 93). **Ask** a volunteer to read the handout.



■ **Say:**

Please take a few moments to reflect on Lola’s advice and how it applies to your life. At the bottom of the handout, there is a space called “A Time To Reflect.” Use this section to record your thoughts and feelings about this week’s session. Remember, this is for you and no one else.

■ **Give** each group member 2 to 3 minutes to write down some thoughts.

■ **Say:**

Changing from **not being** physically active to **being** physically active may take several attempts. It does not matter how many times you try, fail, and start again; the key is not to give up. Keeping a positive attitude will help you to continue taking steps toward a more physically active and healthy lifestyle.

## Pledge for Life!



■ **Give** each group member the “Pledge for Life! Session 3” handout (page 94).



■ **Say:**

You have learned a lot today about how you can become more physically active. Now, let’s think about how you can apply what you have learned. Please think of one change you can make in your everyday life to increase your level of physical activity. This will be your pledge for the week.

■ **Say:**

Be specific about **what** you plan to do, **how** you plan to do it, and **when** you will start. Examples include:

- I will talk to family members and friends this weekend about taking regular walks together.
- I will start walking for at least 20 minutes during my lunch break at work, starting tomorrow.

■ **Say:**

Write your pledge on the “Pledge for Life! Session 3” handout. Keep this handout in a special place so you can review your pledges and keep your goal in mind.



**Note:** Allow 5 minutes for group members to think of a pledge and write it down.

■ **Say:**

Would anyone like to share his or her pledge with the group?



**Note:** Write down pledge ideas on the blackboard or on a large piece of paper taped to the wall.

■ **Say:**

We will talk about how you did with your pledges at the next session. Remember to keep working on your pledges to be prepared if a heart attack happens.

## Closing

---

■ **Say:**

Thank you for coming today. What did you think of today’s session?



**Note:** Allow a moment for group members to respond.

■ **Say:**

I am looking forward to seeing you at the next session. The next session will be about how to cut back on salt and sodium to prevent and control high blood pressure.



**Note for Educator:** Think about today’s class. What worked? What didn’t work? Did the session motivate group members to include physical activity in their lifestyles?

# Role Play: Mila and Cesar Dance Their Way to Heart Health

---

Cesar and Mila's two daughters take a folk dancing class. Their friend Helena's son, Jun, also takes the class. Mila, Cesar, and Helena are talking while waiting for the children to finish folk dance practice.

**Helena:** This is Jun's first time performing on stage. He is a little nervous about dancing at next month's festival—and so am I!

**Mila:** Yes, but it is good for the kids. They love coming to practice, because they get to see their friends. And they learn about the Philippine culture. But I really like these classes, because once the kids have finished practicing, we adults get to dance!

**Cesar:** Yes! We usually do line or ballroom dancing. We have had so much fun that we asked the dance teacher to make it weekly.

**Helena:** Really? Aren't we too old for that?

**Mila:** Oh, no! It gets us in shape for all the parties—the cotillions, weddings, and formal parties. Sometimes, the kids even join the line dancing.

**Helena:** That sounds like fun, but I do not have a lot of time.

**Cesar:** It is not really a lot of time. Since we are already here for the kids, it works out perfectly. We get to catch up with everybody and be a little physically active, too. The children love seeing us dance!

**Mila:** I was shy about getting started, but now I cannot wait for dance practice. This is a great physical activity that Cesar and I love doing! My doctor told me I need to stay physically active, and this is a great way to get your heart pumping and have fun, too.

**Cesar:** Please join us, Helena! Dancing will keep your heart and spirit young. The steps are simple. I will go slowly.

**Helena:** I do like this song—and I have always wanted to learn the steps. Okay—I will try it!

# Getting Started With Physical Activity

---

It's very important to know whether to talk with a doctor before starting a physical activity program.

In the list below, check which people should see a doctor before they begin a physical activity program.

- Manuel is 65 years old and had a heart attack 10 years ago, but he is fully recovered.
- Valentina is 32 years old and had a healthy baby 8 months ago.
- Francisco is 38 years old and has diabetes, but he controls his condition very well with medication.
- Roselle is 35 years old and wants to start being more physically active to lower her high blood pressure and help herself to quit smoking.
- Bella is 27 years old and in good health, and she wants to start running.
- Roberto is 57 years old and broke his leg 2 years ago, but it healed very well. He walks every day but wants to start jogging.



# Getting Started With Physical Activity: Lola Idad's Answers

---

- Manuel **should** see a doctor before starting a physical activity program, because he has had a heart attack. Even though he is fully recovered, he should still check with his doctor.
- Valentina **does not need** to see a doctor before starting a physical activity program. Having a baby is not a risk factor, and she is young.
- Francisco **should** see a doctor before starting a physical activity program, because he has diabetes. Even though he is young and he controls his condition very well with medication, he should still check with his doctor.
- Roselle **should** see a doctor before starting a physical activity program, because she has two risk factors: high blood pressure and smoking.
- Bella **does not need** to see a doctor before starting a physical activity program. Even though she wants to start a harder activity, such as running, she is young (less than 50 years old) and in good health.
- Roberto **should** see a doctor before starting a physical activity program. His broken leg is not a factor, but he should check with the doctor first because he wants to start a harder physical activity program, and he is more than 45 years old.



# Take Heart—Say Yes to Physical Activity

Regular physical activity can help your heart and lungs work better; lower your blood pressure, blood cholesterol, and blood glucose (blood sugar); and help you control your weight. It can also help you relax, feel less tense, sleep better, have more energy, and feel better about yourself. Physical activity can reduce your risk for diabetes and some types of cancer.



**Make staying active part of your life.**

**Lola Idad has learned that the more physical activity you do, the easier it gets.**

I do not wait until the end of the day when I am too tired to do any physical activity. I am active throughout the day. I take the stairs instead of the elevators and walk everywhere I can. Now I am up to walking 60 minutes a day with my friend Victoria. It helps to walk with someone. We are so busy talking, we walk even longer.





# Take Heart—Say Yes to Physical Activity *(continued)*

**Keep moving. Start slowly and work your way up!**

Try to do at least 30 minutes of activity every day. If you're short on time, try three or more 10-minute periods.

## **Start with light activities**

- Slow walking
- Watering the lawn or garden
- Light house cleaning
- Fishing



## **Move to moderate activities**

- Walking at a brisk pace
- Gardening (mowing, raking)
- Dancing
- Doing home repairs
- Practicing tai chi or yoga
- Washing windows and scrubbing floors
- Playing baseball
- Bowling



## **Increase to vigorous activities**

- Playing tennis
- Playing basketball
- Practicing martial arts
- Running or jogging
- Bicycling fast or uphill
- Doing aerobics
- Swimming laps
- Jumping rope
- Roller skating
- Doing heavy construction work



## **Other things to do to help you and your family get started:**

- Leave a pair of walking shoes in your car.
- Set a date and time with a coworker to begin walking.



Lola and her family have all increased their physical activity. They now dance and go for walks at the local park on weekends. Cesar, Ric, and Antonio have started a community basketball league at the local community center.

**Your health and your family's health are priceless. Value it!**

# Lola's Tips for Staying Motivated

---

Staying physically active is challenging, but do not give up! Use this sheet to help you plan your physical activity.

**Choose a physical activity that fits your lifestyle.**

The physical activity I chose is \_\_\_\_\_.

**Set goals.**

My short-term goal is to \_\_\_\_\_ times a week.

My long-term goal is to \_\_\_\_\_ times a week.

**Start slowly.**

My comfortable pace is \_\_\_\_\_.

**Get some support.**

I will ask \_\_\_\_\_ to join me in physical activity.

**Have fun!**

**Add variety.**

Different activities that I can do to stay physically active are \_\_\_\_\_

\_\_\_\_\_.

**Be flexible.**

I will take time to rest when I feel \_\_\_\_\_.

**Track your success.**

I will keep a record of my progress in a \_\_\_\_\_.

**Reward yourself.**

My reward for doing physical activity regularly is \_\_\_\_\_.

My reward for reaching my physical activity goal(s) is \_\_\_\_\_.

Adapted from "Your Fitness Program: Tips for Staying Motivated," Mayo Clinic.

# Stretching Activities

Do these stretches gently and slowly. Do not bounce.

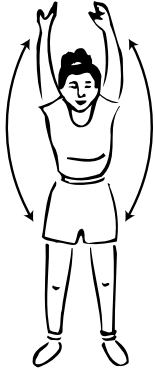

## 1. Deep Breathing

Arms up, breathe in.  
Arms down, breathe out.  
Two times each.

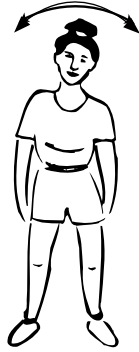

## 2. Neck Stretching

Side to side two times.



## 3. Shoulder Stretches

Up and down five times on each side.

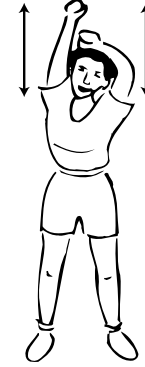

## 4. Side Stretches

Up and down five times in each direction.



## 5. Waist Stretches

Side to side three times in each direction.



## 6. Twists

Side to side three times in each direction.



## 7. Back and Leg Stretches

Down and up five times.

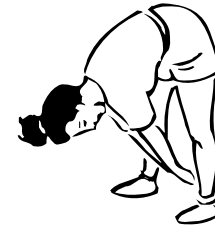

## 8. Back Stretch

Arms through legs six times.

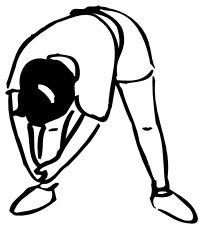

## 9. Leg Stretch 1

Hold onto ankle, four times on each side.



## 10. Leg Stretch 2

Down and up five times.

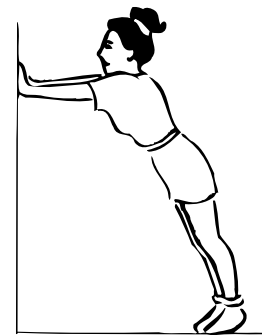

## 11. Leg Stretch 3

Move heels up and down six times.

# Magsimulang Kumilos Sa Mga Aktibidad sa Pag-uunat

Gawin ang mga pag-uunat na ito nang banayad at dahan-dahan. Huwag magpatalbug-talbog.

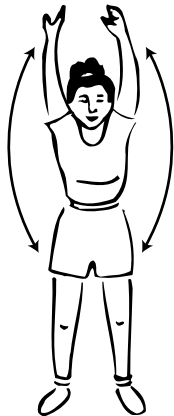

## 1. Malalim na Paghinga

Itaas ang mga braso, huminga paloob. Ibaba ang mga braso, huminga palabas. Dalawang beses bawat isa.

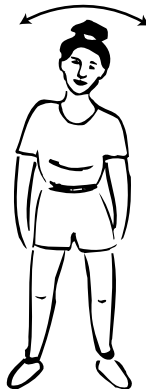

## 2. Pag-uunat ng Leeg

Gilid sa gilid dalawang beses.



## 3. Pag-uunat ng Balik

Itaas at ibaba limang beses sa bawat bahagi.

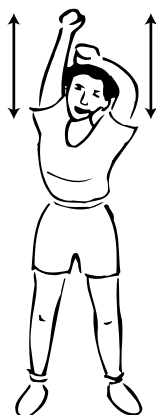

## 4. Mga Pag-uunat ng Gilid

Itaas at ibaba limang beses sa bawat bahagi.



## 5. Mga Pag-uunat ng Baywang

Gilid sa gilid tatlong beses sa bawat direksyon.

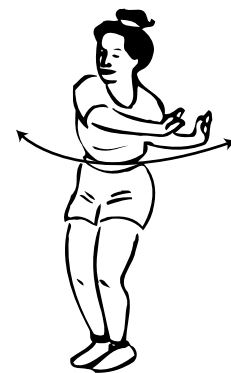

## 6. Mga Pagpipilipit

Gilid sa gilid tatlong beses sa bawat direksyon.

# Magsimulang Kumilos Sa Mga Aktibidad sa Pag-uunat *(continued)*

Gawin ang mga pag-uunat na ito nang banayad at dahan-dahan. Huwag magpatalbug-talbog.

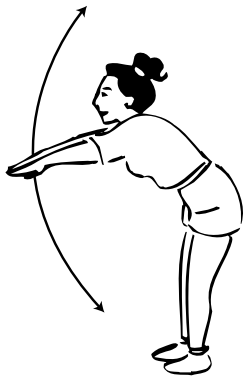

## 7. Mga Pag-uunat ng Likod at Binti

Pataas at pababa nang limang beses.



## 8. Pag-uunat ng Likod

Abutin ng mga braso ang mga binti nang anim na beses.

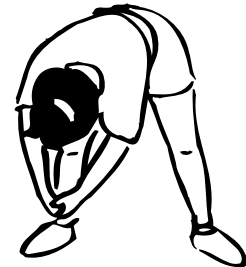

## 9. Pag-unat ng Binti 1

Hawakan ang bukung-bukong, apat na beses sa bawat bahagi.



## 10. Pag-unat ng Binti 2

Pataas at pababa nang limang beses.

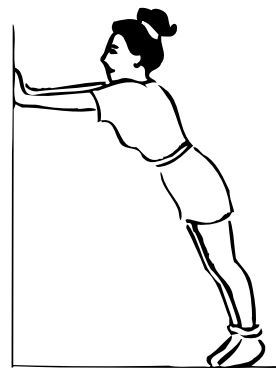
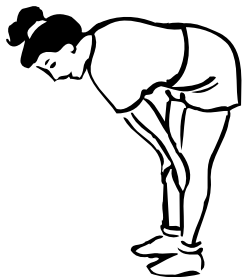

## 11. Pag-unat ng Binti 3

Igalaw ang mga sakong pataas at pababa nang anim na beses.

# Tips on Physical Activity

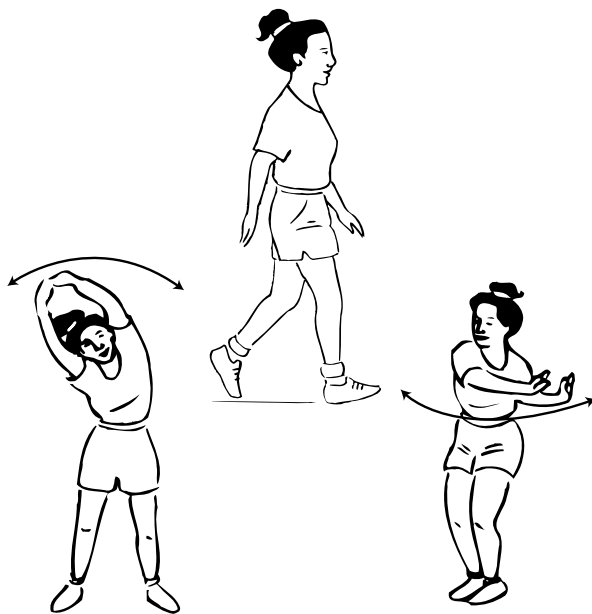

**1.** Walk slowly for 5 minutes. Then do stretching exercises. (See handout on stretching exercises.)

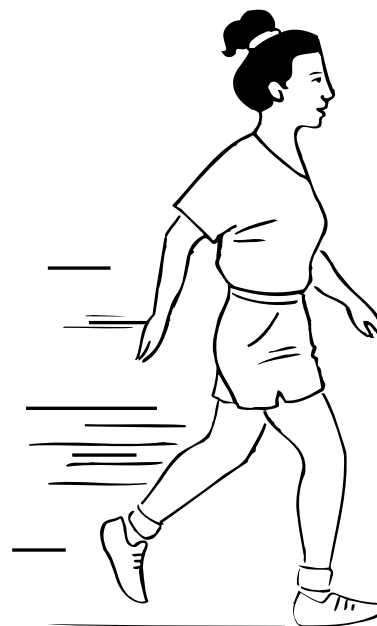

**2.** Walk briskly for 20 minutes.



**3.** Walk slowly for 5 minutes.

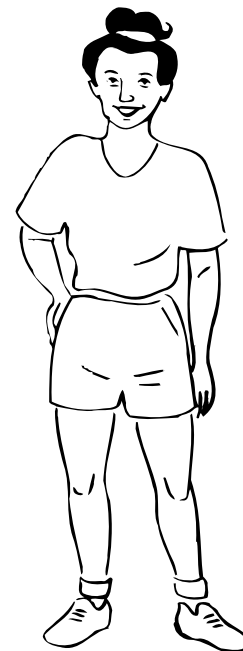

**4.** Relax!

# Make Physical Activity Part of Your Life—My Personal Record

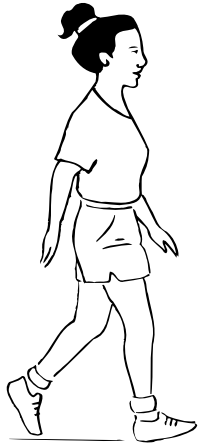

Name: \_\_\_\_\_

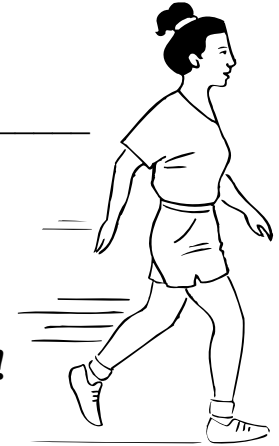

**Track your progress every day.  
Start out slowly.**

**Aim to reach 60 minutes or more each day!**

**Write down the number of minutes you are active each day.**

	Sunday	Monday	Tuesday	Wednesday	Thursday	Friday	Saturday
<b>Example</b>	<i>5min.</i>	<i>5</i>	<i>10</i>	<i>10</i>	<i>15</i>	<i>15</i>	<i>15</i>
<b>Week 1</b>							
<b>Week 2</b>							
<b>Week 3</b>							
<b>Week 4</b>							
<b>Week 5</b>							
<b>Week 6</b>							
<b>Week 7</b>							
<b>Week 8</b>							

# Gawing Bahagi ng Iyong Buhay ang Pisikal na Aktibidad—Aking Personal na Tala



Pangalan: \_\_\_\_\_

**Subaybayan ang iyong progreso araw-araw. Magsimula nang dahan-dahan.**

**Maglayong makaabot ng 60 o higit pa sa isang araw.**

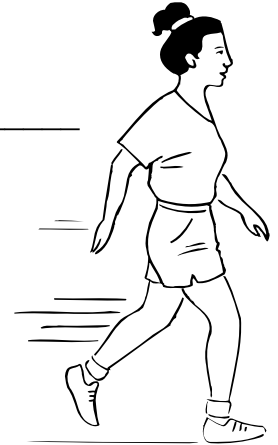

**Isulat ang bilang ng minutong aktibo ka sa bawat araw.**



	Linggo	Lunes	Martes	Miyerkoles	Huwebes	Biyernes	Sabado
<b>Halimbawang 1 Linggo</b>	<i>5 min.</i>	<i>5</i>	<i>10</i>	<i>10</i>	<i>15</i>	<i>15</i>	<i>15</i>
<b>Linggo 1</b>							
<b>Linggo 2</b>							
<b>Linggo 3</b>							
<b>Linggo 4</b>							
<b>Linggo 5</b>							
<b>Linggo 6</b>							
<b>Linggo 7</b>							
<b>Linggo 8</b>							

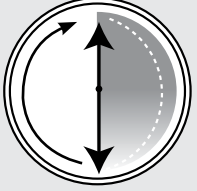

# Sample Walking Program\*

	 <b>Warm Up</b>	 <b>Walk</b>	 <b>Cool Down</b>	 <b>Total Time</b>
<b>Week 1</b>	Walk slowly 5 minutes	Walk briskly 5 minutes	Walk slowly 5 minutes	15 minutes
<b>Week 2</b>	Walk slowly 5 minutes	Walk briskly 10 minutes	Walk slowly 5 minutes	20 minutes
<b>Week 3</b>	Walk slowly 5 minutes	Walk briskly 15 minutes	Walk slowly 5 minutes	25 minutes
<b>Week 4</b>	Walk slowly 5 minutes	Walk briskly 20 minutes	Walk slowly 5 minutes	30 minutes
<b>Week 5</b>	Walk slowly 5 minutes	Walk briskly 25 minutes	Walk slowly 5 minutes	35 minutes
<b>Week 6</b>	Walk slowly 5 minutes	Walk briskly 30 minutes	Walk slowly 5 minutes	40 minutes
<b>Week 7</b>	Walk slowly 5 minutes	Walk briskly 35 minutes	Walk slowly 5 minutes	45 minutes
<b>Week 8</b>	Walk slowly 5 minutes	Walk briskly 40 minutes	Walk slowly 5 minutes	50 minutes

\*Do every day of the week.

# Lola's Life Lessons: Session 3

---

One of my favorite proverbs is:

*“Walang mahirap na gawa pag dinaan sa tiyaga.”*

Translation: “No undertaking is difficult if pursued with perseverance.”

Perseverance means to have courage and diligence. My doctor told me that physical activity is important to health. When he told me that physical activity can help control my high blood pressure, I knew I had to make some changes. I soon learned what the doctor meant. After I am physically active, my mind and body feel stronger. I feel balanced.

Your Lola has not always been this strong. Trying to become more physically active has been challenging! In the Philippines, I used to walk everywhere. I would even walk very far away to get to the market. But when I first came to the United States, I did not feel safe walking around. My friends are not nearby, and the U.S. does not have markets like the Philippines!

Now, I do my morning stretches and go for a walk every day. In the afternoons, I play with little Jo-Jo after he comes home from school. Sometimes we walk to the park, or we dance together while I sing karaoke. Every Thursday, I play mahjong at my friend's house. Mila used to drive me, but now we walk together since it is only five blocks away and in a safe neighborhood.

It has not always been easy, but I do not give up! Nothing is impossible with perseverance.

## **A Time To Reflect...**

What things keep you from being more physically active? What changes can you make in order to become more physically active?

(Use this space to write down your thoughts for this week's session.)

# Pledge for Life! Session 3

---

Take the pledge for life with Lola Idad. Try to do at least one of these activities by yourself and/or share the activities with others.

- Park the car a few blocks away and walk for 10 minutes.
- Play with your children at the local park.
- Start a weekly walking club or dance group.
- Take an interest in a new hobby like ballroom dancing or tai chi.
- Join a community garden project, or start your own garden.
- Take the stairs instead of the elevator or escalator.
- Take a 10-minute walk with a coworker during lunch.
- Start a weekly bowling night with your friends.
- Dance to some music!
- Walk, do not drive, to your friend's house.
- Other \_\_\_\_\_

# Help Your Heart: Control Your High Blood Pressure

---

## Objectives

By the end of this session, group members will learn:

- What blood pressure is
- That it is best to have a blood pressure below 120/80 mmHg (millimeters of mercury)
- That blood pressure between 120/80 and 139/89 mmHg is prehypertension
- That a blood pressure of 140/90 mmHg or greater is high
- What a stroke is and the warning signs of a stroke
- That eating less salt and sodium can lower the risk of developing high blood pressure
- That they can take steps to lower the amount of salt and sodium in their diets

---

## Materials and Supplies

To conduct this session, you will need:

- “Healthy Heart, Healthy Family” manual and picture cards
- Blackboard and chalk or several large pieces of paper, a marker, and tape
- Measuring spoons (1 teaspoon)

- Small amount of salt
- Colored plate or plastic test tube



*(Optional) Note:* Arrange for a health professional to come to the session to take blood pressure readings.

## Handouts

### Give these handouts to each group member during this session:

- List of places where group members can get their blood pressure checked\*
- “Know the Warning Signs of a Stroke. Act Quickly.” (pages 121–122)
- “Stroke Survival Tips” (page 123)
- “My Healthy Heart Wallet Card” (page 124)
- “Take Steps—Healthy Habits To Lower High Blood Pressure!” (page 125)
- *(Optional)* “Role Play: Lola’s Family Works Together To Control High Blood Pressure” (pages 126–127)
- “Read the Nutrition Facts Label for Sodium!” (page 128)
- “Ric’s Food Choices” (pages 129–131)
- “Sodium in Foods” (pages 132–133)
- “Keep Your Heart in Mind: Lola’s Tips To Eat Less Salt and Sodium” (pages 134–135)
- “Tips for Taking Medicine for High Blood Pressure” (pages 136–137)
- “Use Herbs and Spices Instead of Salt” (page 138)
- “Fish Cardillo Recipe” (page 139)

\* Prepare this list before the session. You may find information at your local health department, hospital, or clinic.

- “Lola’s Life Lessons: Session 4” (page 140)
  - “Pledge for Life! Session 4” (page 141)
- 

## **Session Outline**

### **Introducing the Session**

1. Welcome
2. Review of Last Week’s Session
3. About This Session

### **Conducting the Session**

1. The Facts Don’t Lie
2. Facts About Blood Pressure and Stroke
3. Lowering High Blood Pressure
4. Salt and Sodium—How Much Do We Need?
5. *(Optional)* Lola’s Family Works Together To Control High Blood Pressure  
Role Play
6. Nutrition Facts Label Activity—Sodium
7. Shake the Salt and Sodium Habit
8. Easy on the Alcohol
9. Manage Your Blood Pressure With Medicine
10. Fish Cardillo Recipe

### **Review of Today’s Key Points**

### **Lola’s Life Lessons: A Time To Reflect**

## Pledge for Life!

### *(Optional)* Blood Pressure Check

## Closing

# Introducing the Session

---

## 1. Welcome

- Welcome group members to the session.

## 2. Review of Last Week's Session

- Say:

Last week, we talked about why you should be physically active. **What** do you remember about the benefits of being physically active?



**Note:** Allow about 3 minutes for group members to respond. **Write** responses on the blackboard or on a large piece of paper taped to the wall.

- **Add** the following benefits if they are not mentioned.

### **Physical activity:**

- Strengthens your heart and lungs.
- Builds and maintains healthy bones, muscles, and joints.
- Helps you feel better about yourself.
- Helps you control your weight.
- Helps you lower your blood pressure.
- Helps you control your blood cholesterol.

- Helps you sleep better.
- Helps you reduce stress and feelings of depression and anxiety.
- Helps you have more energy.
- Helps lower your chances of developing diabetes (high blood sugar), heart disease, and cancer.

■ **Say:**

At the end of our last session, everyone made a pledge to be more active.



**Note:** Share with the group what you did and what barriers you faced.

■ **Ask:**

Would any of you like to share with the group what you did? What problems did you face (such as not having time or not getting family support)? How did you solve them?



**Note:** Allow about 5 minutes for responses.

### 3. About This Session

■ **Say:**

Today's session is about blood pressure and the steps you can take to lower your blood pressure or keep it from rising.

■ **Say:**

Last week, Lola Idad reminded us that staying strong and physically active comes from seeing the value of your goal and not giving up. She was able to get her family moving on the journey toward a healthier heart.

Lola strongly believes that “*Kung may itinanim, may aanihin,*” which means that if you plant, you will harvest. Lola has found that trying to reach a goal is like growing a plant. A plant needs care and nurturing beyond just potting it. In this session, Lola will share some useful tips based on her success in lowering her blood pressure.



# Conducting the Session

---

## 1. The Facts Don't Lie

### ■ Say:

- More than 65 million people (one in three) in the United States have high blood pressure, which is also called hypertension. Nearly a third of these people don't know they have high blood pressure.
- Another 59 million Americans have prehypertension, which means they are at risk for developing high blood pressure.
- Studies in California find that more Filipino Americans have hypertension than other Asians, Native Hawaiians and other Pacific Islanders, and Caucasians.
- Stroke is the third leading cause of death among Filipino Americans.

## 2. Facts About Blood Pressure and Stroke

### ■ Show picture card 4.1.

### ■ Say:

Blood pressure is the force of blood against the walls of your arteries. Blood pressure is needed to move the blood through your body.

### ■ Show picture card 4.2.

### ■ Say:

Blood pressure is recorded as two numbers—the systolic pressure (as the heart beats) over the diastolic pressure (as the heart relaxes between beats).

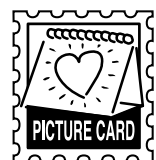
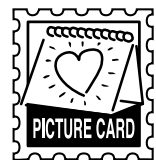

■ **Say:**

The measurement is written one above the other, with the systolic number on top and the diastolic number on the bottom. For example, a blood pressure measurement of 120/80 mmHg (millimeters of mercury) is expressed verbally as “120 over 80.”

■ **Say:**

It is important to keep track of your blood pressure numbers. Write down your numbers every time you have your blood pressure checked.

■ **Ask:**

Do you know your blood pressure numbers?



**Note:** Allow about 2 minutes for responses.



**Note:** Copy this chart on the blackboard or on a large piece of paper taped to the wall.

<b>Your Blood Pressure Numbers</b>			
<b>Level</b>	<b>First Number (mmHg)</b>	<b>Second Number (mmHg)</b>	<b>Results</b>
Normal	Below 120	Below 80	Good for you!
Prehypertension	120–139	80–89	Keep an eye on your blood pressure.  It is time to make changes in your eating and physical activity habits. Visit the doctor if you have diabetes.
High blood pressure	140 or greater	90 or greater	Ask your doctor or nurse how to control it.

■ **Say:**

A normal blood pressure is less than 120/80 mmHg. Blood pressure of 120/80 mmHg to 139/89 mmHg is prehypertension. This means that you do not have high blood pressure yet, but are likely to develop it in the future, unless you make changes in your health habits. Blood pressure is high when it is 140/90 mmHg or greater.

■ **Show picture card 4.3.**

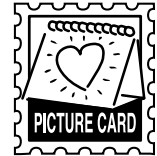

■ **Say:**

If you have high blood pressure or hypertension, it means your heart has to pump harder than it should to get blood to all parts of your body. High blood pressure raises your chances of having a stroke, heart attack, kidney problems, or becoming blind.

■ **Say:**

High blood pressure is known as the “silent killer” because it often has no symptoms. Most people who have it do not feel sick until they have a stroke, heart attack, or some other problem caused by high blood pressure.

■ **Say:**

High blood pressure is a major risk factor for stroke. Other risk factors that increase your chances of having a stroke include heart disease, smoking, diabetes, high blood cholesterol, and overweight/obesity.

■ **Ask:**

Do you know anyone who has had a stroke?



**Note:** Allow a few minutes for group members to respond.

■ **Give** group members the handout “Know the Warning Signs of a Stroke. Act Quickly.” (page 121).



■ **Show picture card 4.4.**

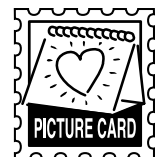

■ **Say:**

A stroke is also called a brain attack. A stroke happens when blood suddenly stops going to the brain and brain cells die. A stroke is very serious and can lead to disability and death.

■ **Say:**

The warning signs of a stroke happen suddenly. A person may have one or more warning signs. The warning signs of a stroke include:

- Numbness of the face, arm, or leg (especially on one side of the body)
- Confusion, trouble talking, and difficulty understanding others
- Trouble seeing with one or both eyes
- Trouble walking, dizziness, and loss of balance or coordination
- Severe headache

■ **Say:**

Ministrokes—or transient ischemic attacks (TIAs)—have the same symptoms as a stroke, but they do not last as long and usually do not cause brain damage. A ministroke is a warning that a stroke may happen in the future.

■ **Say:**

Ministrokes may last a few seconds or an entire day and then go away. These signs should not be ignored. As with a heart attack, act immediately if you or someone you know has stroke symptoms. Calling 9–1–1 right away will help prevent serious problems.

- **Give** group members the “Stroke Survival Tips” handout (page 123).

**Ask** a group member to read aloud.

- **Show picture card 4.5.**



■ **Say:**

Measuring blood pressure is easy and does not hurt. The best way to find out if you have high blood pressure is to have it checked at least once a year. Check it more often if you already have high blood pressure or prehypertension.

■ **Give** group members:

- A list of places (such as clinics and hospitals) to get blood pressure checked
- The “My Healthy Heart Wallet Card” handout (page 124)



■ **Say:**

Ask for your numbers each time you have your blood pressure checked. Keep a record of each reading on the wallet card.

### 3. Lowering High Blood Pressure

Ask group members to raise their hands if someone in their family has high blood pressure.

■ **Say:**

If a member of your family has high blood pressure, you are at greater risk of getting it, too. Even if you do not have high blood pressure now, you are still at greater risk if a family member has it.

■ **Say:**

The good news is that you can take steps now to lower your blood pressure or keep it from rising. Let's find out how.

■ **Give** each group member the “Take Steps—Healthy Habits To Lower High Blood Pressure!” handout (page 125).



■ **Read** aloud the steps to lower high blood pressure or keep it from rising.

■ **Ask:**

Which steps could you and your family take to prevent or lower high blood pressure?



**Note:** Allow 3 minutes for group members to respond.

## 4. Salt and Sodium—How Much Do We Need?



**Note:** For this activity, you will need a  $\frac{1}{4}$ -teaspoon measuring spoon, a 1-teaspoon measuring spoon, and some salt. Use a colored plate or plastic test tube to show the sodium levels.

■ **Say:**

Even though salt is commonly seen as a symbol of good luck, eating less salt and sodium can help you prevent or lower high blood pressure. You know what salt is, but you may wonder what sodium is. Sodium is a part of salt. It is also part of mixtures used to flavor and preserve foods.

■ **Say:**

Most people are eating much more than 500 milligrams of sodium every day.

■ **Say:**

You should cut back the amount of sodium you get from all foods and beverages to less than 2,300 milligrams of sodium—or about 1 teaspoon of salt—per day.



**Note:** Now **show** 1 teaspoon of salt.

■ **Say:**

If you have high blood pressure, it would be helpful to decrease your sodium intake to 1,500 milligrams of sodium per day.



**Note:** Now **show**  $\frac{2}{3}$  teaspoons of salt.

■ **Say:**

Most people in the United States eat about 4,000 to 6,000 milligrams of sodium each day, or about  $2\frac{1}{2}$  teaspoons.



**Note:** Now **show**  $2\frac{1}{2}$  teaspoons of salt.

■ **Say:**

This is about 8 to 12 times more sodium than the body needs. Eating this much salt and sodium may lead to high blood pressure.

■ **Show picture card 4.6.**

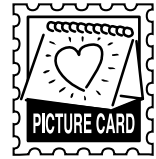

■ **Say:**

Let's talk about what foods are high in sodium.

- Most of the sodium that we eat comes from packaged foods, restaurants, and fast food. Examples of packaged foods are:
  - Sauces and seasonings, such as soy sauce, *patis* (fish sauce), *tuyo* (salty dried fish), and *bagoong alamang* (salted shrimp paste)
  - Regular canned soups and vegetables
  - Frozen dinners
  - Salty chips
  - Canned meat, such as pork and sausages, and fish and seafood, such as salmon, squid, and sardines
  - Meats high in sodium, such as hotdogs and bacon
- When you eat out, most of the food will be high in sodium. If you have high blood pressure, you should eat out less often.
- Sodium also comes from salt added during cooking or at the table.

## 5. (Optional) Lola's Family Works Together To Control High Blood Pressure Role Play

- Give group members the “Role Play: Lola’s Family Works Together To Control High Blood Pressure” (pages 126–127) handout.



**Note:** If you choose, **ask** four volunteers to act out the role play. As the trainer, you can **read** the introduction. After reading the role play, allow 3 to 5 minutes for open discussion.

■ **Say:**

The family helped Ric learn that he has to make some changes to lower his high blood pressure and lower his risk of a stroke.

■ **Ask:**

- What are some of the lessons we learned from this role play?
- Is there any part of the play that you can use in your own life?

■ **Give the following responses if they are not said:**

Jose teaches Ric that:

- High blood pressure often does not have symptoms and is called the “silent killer.”
- Changing his diet and level of physical activity can help Ric control or lower his high blood pressure and reduce his risk of a stroke.
- Jose’s friends made the right decision by calling 9–1–1 right away when he showed signs of a stroke.

## 6. Nutrition Facts Label Activity—Sodium



■ **Say:**

One way Lola has learned to control her high blood pressure is by reading the Nutrition Facts label on food products.

■ **Show picture card 4.7.**

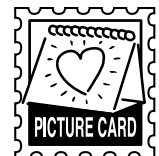

■ **Say:**

The Nutrition Facts label found on packaged foods is one of the best tools we have for choosing foods for a healthy diet. In this session, we will learn how to use the Nutrition Facts label to choose foods that are lower in sodium.

■ **Give group members the “Read the Nutrition Facts Label for Sodium!” handout (page 128).**





■ **Say:**

The Nutrition Facts label lists the serving size and number of servings in the container. It also gives the amount of calories, sodium, saturated fat, *trans* fat, and cholesterol in one serving of the food. We will talk about calories, saturated fat, *trans* fat, and cholesterol in the next two sessions. Today, we will concentrate on sodium.

■ **Point** to where the Percent Daily Value is located on the Nutrition Facts label.

■ **Say:**

The Percent Daily Value helps you compare products. It tells you if a food is high or low in various nutrients. Remember—it is easy to take in more than 2,300 milligrams of sodium. Choose foods with a lower Percent Daily Value for sodium. A Percent Daily Value of **5 or less is low**, and a Percent Daily Value of **20 or more is high**. Once you get into the habit of looking at Nutrition Facts labels, it will be easy.

■ **Say:**

More Asian grocery stores are now carrying products with Nutrition Facts labels, making it easier to choose foods, sauces, and seasonings that are lower in sodium.

■ **Say:**

Let's take a close look at the nutrition facts on an actual label to find the amount of sodium. Let's go back to the "Read the Nutrition Facts Label for Sodium!" handout.

■ **Point** again to picture card 4.7.

■ **Say:**

The Percent Daily Value for sodium in frozen peas and carrots is circled on the Nutrition Facts label.

■ **Say:**

The sodium content of the same food can vary depending on how it is packaged or what brand it is. Compare Nutrition Facts labels to choose foods that are lower in sodium.

■ **Say:**

Look at the bottom of the handout. Look at the Percent Daily Value for frozen peas and carrots and for canned peas and carrots. Which peas and carrots are lower in sodium?

■ **Say:**

Frozen peas and carrots are lower in sodium. One serving of frozen peas and carrots has only 5 percent of the Daily Value for sodium. One serving of canned peas and carrots has 15 percent of the Daily Value for sodium. In other words, the canned peas and carrots have three times more sodium than frozen peas and carrots. Rinsing the canned peas and carrots in cold water can help reduce the sodium content.

**More Information:  
Potassium, Calcium, and Magnesium**

The latest research shows that foods rich in potassium are important in protecting against high blood pressure. Foods rich in calcium and magnesium may help, too.

**Good Sources of Potassium, Calcium, and Magnesium:**

- **Potassium:** bananas, plantains, papayas, oranges, prunes, tomatoes, potatoes, spinach, and dry beans
- **Calcium:** low-fat milk; low-fat, reduced-sodium cheese; low-fat yogurt; calcium-fortified orange juice; leafy greens; and fresh or rinsed canned fish
- **Magnesium:** whole-grain breads and cereals, oatmeal, brown rice, beans, nuts, seeds, okra, and spinach

One eating plan that can lower blood pressure is Dietary Approaches to Stop Hypertension (DASH). By using the DASH plan, you can lower your blood pressure by eating:

- Lots of fruits and vegetables
- Fat-free or low-fat milk products
- Whole-grain products
- Fish, poultry, and lean meats
- Nuts, seeds, and dry beans

The DASH eating plan also includes:

- Less salt and sodium
- Small amounts of fats and oils
- Small amounts of sweets and beverages that are high in sugar

People with high blood pressure will get extra benefits from following the DASH eating plan and eating foods low in salt and sodium. This combination is also heart healthy for people who do not have high blood pressure.

■ **Say:**

Choosing and preparing foods that are lower in salt and sodium may help prevent or lower high blood pressure. Eating more fruits and vegetables, whole-grain breads and cereals, and fat-free or low-fat milk products, or fat-free or low-fat lactose-free products, also may help lower blood pressure.

■ **Say:**

Let's try an activity that will help us choose foods that are low in salt and sodium. First, I am going to describe a situation that may apply to you or to a member of your family. Then, using Nutrition Facts labels, we are going to learn how to choose lower-sodium foods.

- Give each group member the “Ric’s Food Choices” handout (pages 129–131). Read or ask a volunteer to read the story below.



### Ric’s Food Choices

Ric’s blood pressure was slightly higher the last time he visited his doctor. The doctor told him to cut back on the amount of sodium he eats. Use the Nutrition Facts labels to help Ric choose foods that will help him follow his doctor’s advice.

- Say:

Let’s go over some questions. Use the Nutrition Facts labels to choose the foods that are lower in sodium.

- Ask these questions. Give the correct answer after group members guess.

#### Questions

When buying juice, should Ric choose tomato juice or pineapple juice?

Pineapple juice

Should Ric buy soy sauce or light soy sauce?

Light soy sauce

Should Ric eat unsalted dry roasted peanuts or beef jerky?

Dry roasted peanuts, unsalted

Should Ric eat regular canned pork or chicken siopao?

Chicken siopao

Should Ric snack on pork rinds or low-sodium crackers?

Low-sodium crackers

## 7. Shake the Salt and Sodium Habit

- **Give** group members the “Sodium in Foods” handout (pages 132–133).



- **Ask:**

Does anyone see a food on the right side of the page that you eat often?

- **Ask** the person to name a lower-sodium food on the left side that he or she could eat instead.

- **Say:**

Let’s now review some practical tips that will help you cut back on salt and sodium.

- **Give** each group member a copy of the “Keep Your Heart in Mind: Lola’s Tips To Eat Less Salt and Sodium” handout (pages 134–135). **Review** the tips on how to cut back on salt and sodium when shopping, cooking, and eating.



- **Say:**

Here is Lola’s favorite tip to control high blood pressure. Gradually decrease the sodium in your diet, and cook with seasonings and sauces that are low in sodium.

- **Ask:**

Why is it hard for you to cut back on salt and sodium?



**Note:** Allow 3 minutes for group members to respond. **Write** their responses on the blackboard or on a large piece of paper taped to the wall. Then **write** down some possible solutions. See the “Examples” box for some problems and solutions.

## Salt Solutions Examples

### **Problems You May Encounter**

### **Solutions**

**Using fewer traditional sauces or seasonings is difficult.**

When preparing foods, use a smaller amount of the sauces and seasonings that are high in sodium. Replace some with light versions, such as light soy sauce, which has less sodium.

**The food has no flavor.**

Use herbs and spices to add flavor to foods. See the “Use Herbs and Spices Instead of Salt” handout (page 138).

**Family members will get upset.**

Cut back on salt slowly. Use less salt each time you cook, so family members can get used to the taste.

**Adding salt is a hard habit to break.**

Give yourself time to get used to using less salt. Choose brands that are lower in salt. Take the saltshaker off the table.

## 8. Easy on the Alcohol

### ■ Say:

Drinking too much alcohol can raise your blood pressure. It can also harm the liver, brain, and heart. Alcoholic drinks also contain calories. The extra calories can make it hard to control your weight.

If you do not drink alcohol, don't start. If you drink alcohol, drink only a moderate amount. That means:

- Men should have no more than two drinks a day.
- Women should have no more than one drink a day.
- Pregnant women should not drink any alcohol.

■ **Ask:**

What do you think counts as one drink?



**Note:** Allow a few minutes for group members to respond.

■ **Say:**

One drink is:

- 12 ounces of beer (regular—150 calories, light—100 calories)
- 5 ounces of wine (100 calories)
- 1½ ounces of liquor (100 calories)

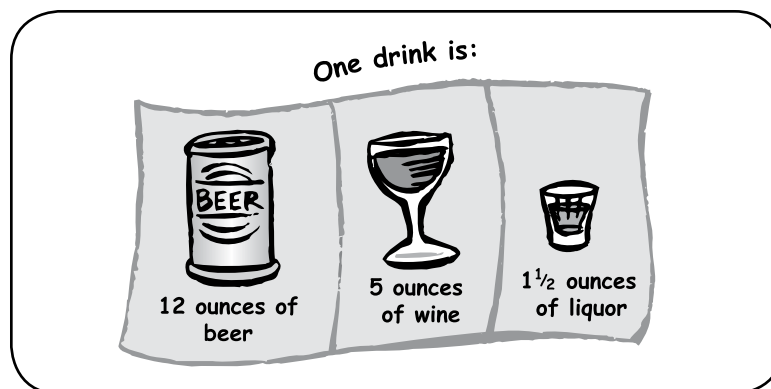

## 9. Manage Your Blood Pressure With Medicine



**Note:** The general term “medicine” refers to Western medicine.

■ **Say:**

If you have high blood pressure, making the lifestyle changes we just discussed may not be enough to lower your blood pressure. Medications are available to lower blood pressure. They work in different ways.

- **Give** group members the “Tips for Taking Medicine for High Blood Pressure” handout (pages 136–137).



■ **Ask:**

Do any of you take medicines for high blood pressure?

■ **Read** aloud the “Tips for Taking Medicine for High Blood Pressure” handout.

■ **Ask:**

If you are taking medication for high blood pressure, what are some things you can do to help your medicines work better?



**Note:** Allow a few minutes for group members to respond.

■ **Add** the following suggestions if they are not mentioned:

- Ask your doctor the name of your medicine and how to take it.
- Take your medicine the way the doctor tells you.
- Tell your doctor the names of all other medicines, home remedies, herbs, supplements, or any traditional Asian medicine you take.
- Tell your doctor if the medicine makes you feel strange or sick.
- Refill your prescription before you run out of medicine.
- Have your blood pressure checked to see if the medicine is working for you.
- Keep taking the medicine as your doctor tells you, even if your blood pressure is okay.

■ **Say:**

Some people use traditional medicine or home remedies instead of or in addition to Western medicine. Tell your doctor if you are using traditional Asian medicine or home remedies. The doctor needs to know if you are taking anything that does not work well with your prescribed medicine(s).



## More Information

### Medicine for High Blood Pressure

- Many people with high blood pressure take more than one medicine to keep their blood pressure low.
- Some medicines can cause side effects or reactions. If this happens, talk to your doctor.
- Eating more fruits and vegetables, cutting back on salt and sodium, starting an eating pattern of low saturated fat and low cholesterol, losing weight, and being physically active can help your medicines work better.

## 10. Fish Cardillo Recipe

- Give group members the “Use Herbs and Spices Instead of Salt” handout (page 138). Ask them to use some of the herbs and spices in place of salt when they cook this week.
- Give group members the “Fish Cardillo Recipe” handout (page 139). Ask them to prepare it during the coming week. Tell them that using this recipe will give them a chance to practice some of the ideas from the session.

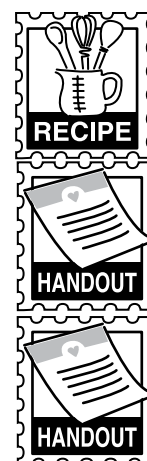

## Review of Today's Key Points

### ■ Say:

Let's review what we learned today.

### What is blood pressure?

- Blood pressure is the force of blood against the walls of your arteries. Blood pressure is necessary to move blood through your body.

### **What is a normal blood pressure?**

- A normal blood pressure is below 120/80 mmHg.

### **What is prehypertension?**

- Blood pressure of 120/80 to 139/89 mmHg is prehypertension. This means that you do not have high blood pressure yet, but you're likely to develop it in the future unless you make changes in your health habits.

### **What is high blood pressure?**

- High blood pressure is 140/90 mmHg or greater. Have your blood pressure checked. If it is 140/90 mmHg or greater, see your doctor.

### **Why is high blood pressure dangerous?**

- High blood pressure can lead to heart attack, stroke, kidney problems, eye problems, and death.

### **What can you do to help make your blood pressure medicine work better?**

- Eat more fruits and vegetables, cut back on salt and sodium, lose weight, and be more physically active. Take your medicine as your doctor tells you. Talk to your doctor about side effects.

### **Why should you cut back on salt and sodium in your food?**

- You should cut back on salt and sodium to help prevent or lower high blood pressure.

### **What are some ways to cut back on salt and sodium?**

- Use herbs and spices to season foods. Be careful! Some seasonings such as garlic salt and onion salt are high in sodium. Check the Nutrition Facts label to choose foods lower in sodium. Eat more fruits and vegetables for snacks instead of salty snacks such as nuts, pretzels, or chips.

### **How can drinking alcohol affect your blood pressure?**

- Drinking too much alcohol can raise blood pressure.

### What is a stroke?

- A stroke occurs when blood suddenly stops going to the brain. This can happen for different reasons. One reason is that a blood vessel bursts. Another is that a clot blocks the arteries. Either way, the result is the same: blood stops going to the brain, and brain cells die. Both types of stroke are very serious and can lead to disability and death.

### What is another name for a stroke?

- A stroke is also called a brain attack.

## Lola's Life Lessons: A Time To Reflect

---

### ■ Say:

In the last session, Lola Idad reminded us that setting goals and not giving up can help us make the necessary lifestyle changes. Perseverance must be combined with an awareness of your actions. It requires you to look at your habits and to plan for the future.

### ■ Say:

You have learned a lot today about how to prevent and control high blood pressure. You also learned how to cut back on salt and sodium. Now let's think about how you can practice what you have learned. Please think of one change you can make in your everyday life.

### ■ Say:

Be specific about **what** you plan to do, **how** you plan to do it, and **when** you will start. Here are some examples:

- I will get my blood pressure checked within the next month.
- I will read Nutrition Facts labels the next time I go to the store to help me choose canned vegetables that are lower in sodium, or I will prepare fresh or frozen vegetables without adding salt.

- I will rinse canned foods with water before I cook or eat them, starting tomorrow.
- I will take the saltshaker off the table, starting tomorrow.

- Give each group member the “Lola’s Life Lessons: Session 4” handout (page 140).



- Ask a volunteer to read the handout.

- Say:

Please take a few moments to reflect on Lola’s advice and how it applies to your life. At the bottom of the handout, there is a space called “A Time To Reflect.” Use this section to record your feelings about this week’s session. Please write down your thoughts. Remember, this is for you and no one else.

- Give each group member 2 to 3 minutes to **write** down some thoughts.

## Pledge for Life!



- Give each group member the “Pledge for Life! Session 4” handout (page 141).



- Say:

Take the pledge for life with Lola Idad. Lola and her family have taken the pledge to practice heart healthy eating daily. Take the step toward healthy eating and lowering your blood pressure. Pledge to do one thing on this list during the coming week. Now, let’s start by sharing our goals with each other.

- Say:

Would anyone like to share his or her pledge with the group?



**Note:** Write down pledge ideas on the blackboard or on a large piece of paper taped to the wall.

■ **Say:**

We will talk about how you did with your pledges at the next session.  
Remember to keep working on your pledges to be more physically active.

## Blood Pressure Check

---

*(Optional—Try to get a health professional to come to your session.)*

- **Tell** group members that a health professional will now check everyone's blood pressure.
- **Ask** group members to **write** their blood pressure numbers on the “My Healthy Heart Wallet Card” handout.

## Closing

---

■ **Say:**

Thank you for coming today. What did you think of today's session?



**Note:** Wait to see if group members respond.

■ **Say:**

I am looking forward to seeing you at the next session. The next session will be about how to prevent and control high blood cholesterol.



**Note for Educator:** Think about today's session. What worked and what didn't work? Have you decided to make any changes in your own lifestyle based on what was covered in today's session to control or prevent high blood pressure?

# Know the Warning Signs of a Stroke. Act Quickly.

A stroke happens when blood suddenly stops going to the brain and brain cells die. A stroke is very serious and can lead to disability and death.

## Signs of a stroke:

- Numbness of the face, arm, or leg (especially on one side of the body)
- Confusion, trouble talking, and difficulty understanding others
- Trouble seeing in one or both eyes
- Trouble walking, dizziness, and loss of balance or coordination
- Severe headache

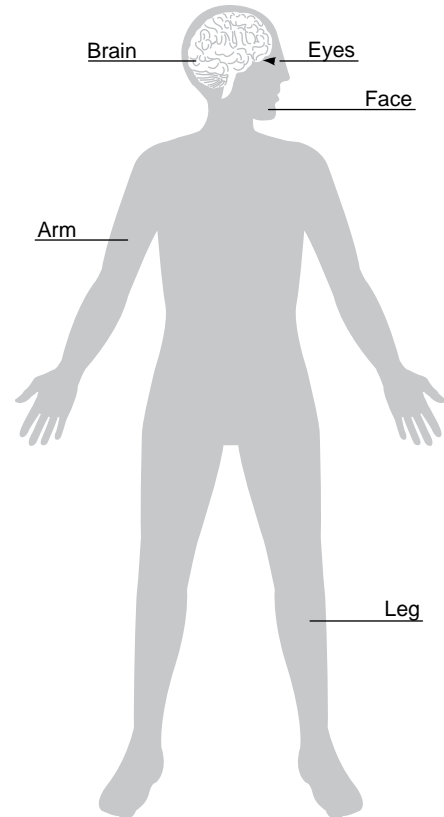

## A Stroke Is Serious. Every Second Counts.

- Learn the warning signs of a stroke, and teach them to your family and friends.
- Call 9–1–1 immediately if you have any of these stroke warning signs.
- Treatment can reduce the risk of damage from a stroke. You must get help within 3 hours of your first symptoms.

Adapted from the American Stroke Association, “Let’s Talk About Risk Factors for Stroke,” 1999–2003. A division of the American Heart Association.

# Alamin ang Mga Senyales ng Babala ng isang Stroke. Kumilos Kaagad.

Nangyayari ang isang stroke kapag biglang tumigil ang pagpunta ng dugo sa utak, at mamamatay ang mga selula sa utak. Ang isang stroke ay napakaseryoso at maaaring humantong sa pagkabaldado at pagkamatay.

## Mga Senyales ng Isang Stroke:

- Pamamanhid ng mukha, braso, o binti (lalo na sa isang bahagi ng katawan)
- Pagkalito, problema sa pagsasalita, at paghihirap sa pag-unawa sa iba
- Problema sa pagtingin sa isang mata o kapwa mga mata
- Problema sa paglalakad, pagkahilo, at kawalan ng balanse o koordinasyon
- Matinding sakit ng ulo

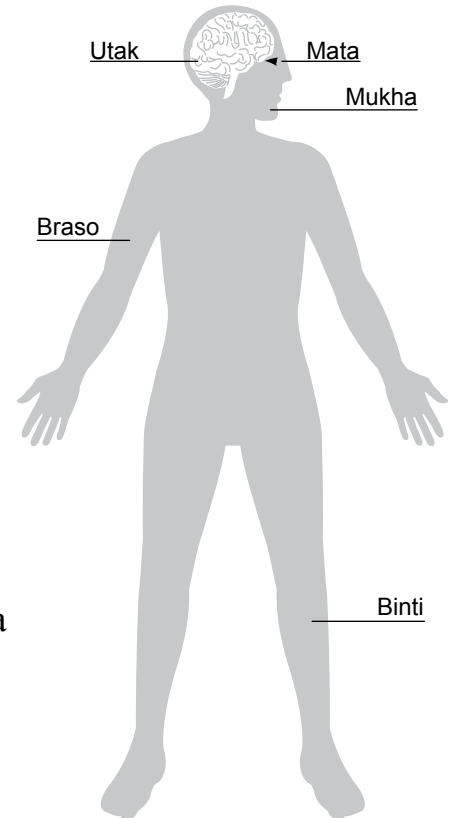

## Seryoso ang Isang Stroke. Ang Bawat Sandali ay Mahalaga.

- Alamin ang mga senyales ng babala ng isang stroke, at ituro ang mga ito sa iyong pamilya at mga kaibigan.
- Tumawag kaagad sa 9–1–1 kung mayroon kang alinman sa mga senyales ng babala ng stroke.
- Maaaring mabawasan ng paggagamot ang peligro ng pinsalang dulot ng isang stroke. Dapat kang humingi ng tulong sa loob ng 3 oras ng iyong unang sintomas.

Alinsunod sa American Stroke Association, “Let’s Talk About Risk Factors for Stroke,” 1999–2003. Isang dibisyon ng American Heart Association.

# Stroke Survival Tips

---

- Know the symptoms of a stroke. This can help you act quickly if you feel ill.
- Keep a card with emergency numbers and a list of your medications with you at all times. The information will allow emergency medical personnel to contact your doctor, a friend, or a relative who can provide information on medications you are taking.
- Keep a phone on a low table. This will help you if you fall during a stroke or are unable to walk to a telephone and call for help.
- Keep a clock in the bedroom, living room, and kitchen, or wear a watch. If you think you are having a stroke, check the time so you will know when the first symptom appeared.
- Place a pad and pen on your nightstand with a checklist of medicines. Keep your checklist of medicines updated. If you have a stroke, tell emergency medical personnel where to find the list. This will help the health professionals know how best to treat you.
- Give a spouse, family member, or neighbor a list of the warning signs of a stroke and your emergency numbers. They may be able to help you if you have a stroke or provide important information to emergency medical personnel.



Adapted from the National Council on Aging's "Stroke Survival Tips," 2003.



# My Healthy Heart Wallet Card

Cut along dotted lines. Fold the card in half and paste with a glue stick (fold 1).  
Fold in half again to make your own personal wallet card (fold 2).

## Try these tips for a healthy heart!

- More**  + fruits, vegetables, whole grains, and fat-free or low-fat milk products
- + physical activity 
- Less** - calories, saturated and *trans* fat, cholesterol, and sodium
- None**  - weight and waist measure  
0 cigarettes

= A healthy heart



U.S. Department of Health and Human Services  
National Institutes of Health



National Heart Lung and Blood Institute  
People Science Health

## Take Care of Your Heart



### Check your:

blood pressure, blood cholesterol, weight, waist measure, and blood glucose

Name \_\_\_\_\_

(FOLD 2)

(FOLD 1)

Front

### Blood Pressure

Less than 120/80 mmHg

**Total Cholesterol**

Less than 200 mg/dL

**LDL**

Less than 100 mg/dL—ideal

Less than 130 mg/dL—near ideal

**HDL**

More than 40 mg/dL

**Triglycerides**

Less than 150 mg/dL

### Blood tests to measure fats in the blood

Date				
Value				

Back

### Weight

Date				
Value				

### Waist measurements

Men: 40 inches or less

Women: 35 inches or less

Date				
Value				

### Blood tests to check sugar in the blood for diabetes

### Blood glucose (fasting)

Less than 100

Date				
Value				

### A1C

7% or less

Date				
Value				

Talk to your doctor about what these numbers mean!

# Take Steps—Healthy Habits To Lower High Blood Pressure!

## To prevent high blood pressure:

### 1. Maintain a healthy weight.

Try not to gain extra weight. Lose weight if you are overweight. Try losing weight slowly, about 1 to 2 pounds (0.45 to 0.91 kilogram) each week until you reach a healthy weight.



### 2. Be active every day for at least 30 minutes.

You can walk, dance, play sports, or do any activity you enjoy.



### 3. Eat less salt and sodium.

Buy foods marked “sodium free,” “low sodium,” or “reduced sodium.” Take the saltshaker off the table.

### 4. Eat more fruits and vegetables, whole-grain breads and cereals, and fat-free or low-fat milk products.

### 5. Cut back on alcohol.

Men who drink should have no more than one or two drinks each day. Women who drink should have no more than one drink a day. Pregnant women should not drink any alcohol.

## To lower high blood pressure:

### 1. Practice these steps:

- Maintain a healthy weight.
- Be physically active every day for at least 30 minutes.
- Eat fewer foods and sauces high in salt and sodium.
- Eat more fruits and vegetables, whole-grain breads and cereals, and fat-free or low-fat milk products.
- Cut back on alcoholic beverages.

### 2. Take your medicine the way your doctor tells you.

### 3. Have your blood pressure checked often.



# Role Play: Lola's Family Works Together To Control High Blood Pressure

---

Mila and Cesar are getting ready for bed. They are discussing Mila's younger brother, Ric, who lives with them and recently visited the doctor's office.

**Cesar:** Ric finally went to Dr. Cabaya for his annual checkup and found out that he has high blood pressure! The doctor told Ric that he has to eat fewer salty foods and become more physically active. I tried to tell him to follow Dr. Cabaya's advice, but he said he feels fine. He just does not want to change.

**Mila:** Do you think it would help him to talk to your brother Jose? Since his stroke, Jose has changed his eating habits and started walking regularly. Even he had a hard time getting started ... and he is a nurse!

**Cesar:** That's a good idea. Ric may listen to him. Let's invite Jose and his family over for dinner.

**Later that week, Jose and his family have dinner with Cesar, Mila, and Ric. Jose and Ric are talking before dinner.**

**Ric:** *Kuya*\* ("elder brother"), I hate going to the doctor. They always find something wrong! Now I have to eat foods low in sodium and do physical activity to control my high blood pressure. That makes no sense! I do not understand why I should be so concerned about this now. I feel fine.

**Jose:** It doesn't matter how you feel or look. Many people do not have symptoms when they have high blood pressure. That is why it is called the "silent killer."

**Ric:** Silent killer? What do you mean? I am strong.

\*It is common to address an older gentleman for whom you have a lot of respect as "*Kuya*," whether he is blood related or not.

# Role Play: Lola's Family Works Together To Control High Blood Pressure *(continued)*

---

**Jose:** It means that it can go undetected if you do not have it diagnosed by a health professional and try to lower it to within the normal range. Look, I am a nurse and even I did not try to lower my high blood pressure. Then I had a stroke, remember? I am lucky that my friends recognized the signs of a stroke and called 9–1–1 right away.

If I had lowered my blood pressure earlier, my chances of having the stroke would have been much lower. I wish I had not had the stroke, but it was a big wake-up call.

**Ric:** Yes, that was scary. I was surprised, because you are only 5 years older than I am. But I am not too heavy. I play basketball all the time.

**Jose:** Ric, that is good. Then you should make those changes to your lifestyle. Maybe you could lose a little weight—I have lost 20 pounds (9 kilograms) since I got serious about lowering my blood pressure. I also take blood pressure medicine as my doctor prescribes.

**Ric:** Okay, okay, okay. I see I need to make the changes now. Thanks, Kuya!

**Jose:** Let's eat. Mila made her fish *cardillo*.

# Read the Nutrition Facts Label for Sodium!



Nutrition Facts labels tell you what you need to know about choosing foods that are lower in sodium. Here is a Nutrition Facts label for frozen peas and carrots.

## Frozen Peas and Carrots

Nutrition Facts	
Serving Size ½ cup (121g)	
Servings Per Container 3	
Amount Per Serving	
Calories 50	Calories from Fat 0
% Daily Value*	
<b>Total Fat</b> 0g	0%
Saturated Fat 0g	0%
Trans Fat 0g	
<b>Cholesterol</b> 0mg	0%
<b>Sodium</b> 125mg	5%
<b>Total Carbohydrate</b> 9g	3%
Dietary Fiber 3g	12%
Sugars 4g	
<b>Protein</b> 2g	
Vitamin A 35%	Vitamin C 6%
Calcium 2%	Iron 2%

### Amount Per Serving

The nutrient amounts are for one serving. So, if you eat more or less than a serving, you need to add or subtract nutrient amounts. For example, if you eat 1 cup of peas and carrots, you are eating two servings.

### Nutrients

Listed are the amounts of sodium in one serving. These amounts are given in milligrams (mg).

### Serving Size and Number of Servings

The serving size is ½ cup. The package contains about three servings. Remember, the numbers on the label are for one serving, not the whole container.

### Percent Daily Value

The Percent Daily Value helps you compare products and quickly tells you if the food is high or low in sodium. Choose products with the lowest Percent Daily Value for sodium: 5 percent or less is low, and 20 percent or more is high.

## The Choice Is Yours—Compare!

### Which one would you choose?

Frozen peas and carrots are lower in sodium than canned. Read the labels, and choose foods that are lower in sodium to help keep your heart strong.

Calories 50	Calories from Fat 0
% Daily Value*	
<b>Total Fat</b> 0g	0%
Saturated Fat 0g	0%
Trans Fat 0g	
<b>Cholesterol</b> 0mg	0%
<b>Sodium</b> 125mg	5%

### Frozen Peas and Carrots

One serving (½ cup) of frozen peas and carrots has 125 mg of sodium and 5 percent of the Daily Value for sodium.

Calories 60	Calories from Fat 0
% Daily Value*	
<b>Total Fat</b> 0g	0%
Saturated Fat 0g	0%
Trans Fat 0g	
<b>Cholesterol</b> 0mg	0%
<b>Sodium</b> 360mg	15%

### Canned Peas and Carrots

One serving (½ cup) of canned peas and carrots has 360 mg of sodium and 15 percent of the Daily Value for sodium. That is almost three times the sodium found in a serving of frozen peas and carrots.

\* Percent Daily Values are based on a 2,000-calorie diet. Your Daily Values may be higher or lower depending on your calorie needs.

# Ric's Food Choices



Ric's blood pressure was slightly higher the last time he visited his doctor.

The doctor told him to cut back on the amount of sodium he eats.

Use the Nutrition Facts labels to help Ric choose foods that will help him follow his doctor's advice.

Write the number of your choice for each pair in the space between the labels.

## 1 – Tomato Juice

Nutrition Facts	
Serving Size ¾ cup (177 ml)	
Servings Per Container 1	
Amount Per Serving	
<b>Calories</b> 30	Calories from Fat 0
% Daily Value*	
<b>Total Fat</b> 0g	<b>0%</b>
Saturated Fat 0g	0%
Trans Fat 0g	
<b>Cholesterol</b> 0mg	<b>0%</b>
<b>Sodium</b> 660mg	<b>27%</b>
<b>Total Carbohydrate</b> 7g	<b>2%</b>
Dietary Fiber 0g	0%
Sugars 6g	
<b>Protein</b> 1g	
Vitamin A 6%	Vitamin C 0%
Calcium 0%	Iron 5%

## 2 – Pineapple Juice

Nutrition Facts	
Serving Size ¾ cup (177 ml)	
Servings Per Container 1	
Amount Per Serving	
<b>Calories</b> 85	Calories from Fat 0
% Daily Value*	
<b>Total Fat</b> 0g	<b>0%</b>
Saturated Fat 0g	0%
Trans Fat 0g	
<b>Cholesterol</b> 0mg	<b>0%</b>
<b>Sodium</b> 10mg	<b>0%</b>
<b>Total Carbohydrate</b> 22g	<b>7%</b>
Dietary Fiber 0g	0%
Sugars 20g	
<b>Protein</b> 1g	
Vitamin A 0%	Vitamin C 100%
Calcium 2%	Iron 2%

Lower sodium choice

## 3 – Soy Sauce

Nutrition Facts	
Serving Size 1 Tablespoon	
Servings Per Container 20	
Amount Per Serving	
<b>Calories</b> 10	Calories from Fat 0
% Daily Value*	
<b>Total Fat</b> 0g	<b>0%</b>
Saturated Fat 0g	0%
Trans Fat 0g	
<b>Cholesterol</b> 0mg	<b>0%</b>
<b>Sodium</b> 920mg	<b>38%</b>
<b>Total Carbohydrate</b> 0g	<b>0%</b>
Dietary Fiber 0g	0%
Sugars 0g	
<b>Protein</b> 2g	
Vitamin A 0%	Vitamin C 0%
Calcium 0%	Iron 0%

## 4 – Light Soy Sauce

Nutrition Facts	
Serving Size 1 Tablespoon	
Servings Per Container 20	
Amount Per Serving	
<b>Calories</b> 10	Calories from Fat 0
% Daily Value*	
<b>Total Fat</b> 0g	<b>0%</b>
Saturated Fat 0g	0%
Trans Fat 0g	
<b>Cholesterol</b> 0mg	<b>0%</b>
<b>Sodium</b> 600mg	<b>25%</b>
<b>Total Carbohydrate</b> 0g	<b>0%</b>
Dietary Fiber 1g	4%
Sugars 0g	
<b>Protein</b> 1g	
Vitamin A 0%	Vitamin C 0%
Calcium 0%	Iron 0%

Lower sodium choice

\* Percent Daily Values are based on a 2,000-calorie diet. Your Daily Values may be higher or lower depending on your calorie needs.

# Ric's Food Choices *(continued)*

## 5 – Dry Roasted Peanuts, Unsalted

Nutrition Facts	
Serving Size 1 oz	
Servings Per Container 16	
Amount Per Serving	
<b>Calories</b> 178	Calories from Fat 130
% Daily Value*	
<b>Total Fat</b> 14g	<b>22%</b>
Saturated Fat 2g	<b>10%</b>
<i>Trans</i> Fat 0g	
<b>Cholesterol</b> 0mg	<b>0%</b>
<b>Sodium</b> 0mg	<b>0%</b>
<b>Total Carbohydrate</b> 5g	<b>2%</b>
Dietary Fiber 2g	<b>8%</b>
Sugars 1g	
<b>Protein</b> 8g	
Vitamin A 2%	• Vitamin C 0%
Calcium 8%	• Iron 0%

Lower sodium choice

## 6 – Beef Jerky

Nutrition Facts	
Serving Size 1 ounce	
Servings Per Container 4	
Amount Per Serving	
<b>Calories</b> 80	Calories from Fat 10
% Daily Value*	
<b>Total Fat</b> 1g	<b>2%</b>
Saturated Fat 0g	<b>0%</b>
<i>Trans</i> Fat 0g	
<b>Cholesterol</b> 25mg	<b>8%</b>
<b>Sodium</b> 460mg	<b>19%</b>
<b>Total Carbohydrate</b> 6g	<b>2%</b>
Dietary Fiber 0g	<b>0%</b>
Sugars 4g	
<b>Protein</b> 10g	
Vitamin A 0%	• Vitamin C 0%
Calcium 0%	• Iron 6%

## 7 – Canned Pork, Regular

Nutrition Facts	
Serving Size 2 ounces (56g)	
Servings Per Container 1	
Amount Per Serving	
<b>Calories</b> 180	Calories from Fat 140
% Daily Value*	
<b>Total Fat</b> 16g	<b>25%</b>
Saturated Fat 6g	<b>30%</b>
<i>Trans</i> Fat 0g	
<b>Cholesterol</b> 40mg	<b>13%</b>
<b>Sodium</b> 300mg	<b>12%</b>
<b>Total Carbohydrate</b> 2g	<b>1%</b>
Dietary Fiber 0g	<b>0%</b>
Sugars 0g	
<b>Protein</b> 8g	
Vitamin A 0%	• Vitamin C 0%
Calcium 0%	• Iron 2%

Lower sodium choice

## 8 – Chicken Siopao (Steamed Bun With Chicken Filling)

Nutrition Facts	
Serving Size 1 Tablespoon	
Servings Per Container 20	
Amount Per Serving	
<b>Calories</b> 10	Calories from Fat 0
% Daily Value*	
<b>Total Fat</b> 0g	<b>0%</b>
Saturated Fat 0g	<b>0%</b>
<i>Trans</i> Fat 0g	
<b>Cholesterol</b> 0mg	<b>0%</b>
<b>Sodium</b> 600mg	<b>25%</b>
<b>Total Carbohydrate</b> 0g	<b>0%</b>
Dietary Fiber 1g	<b>8%</b>
Sugars 0g	
<b>Protein</b> 1g	
Vitamin A 0%	• Vitamin C 0%
Calcium 0%	• Iron 0%

\* **Percent Daily Values** are based on a 2,000-calorie diet. Your Daily Values may be higher or lower depending on your calorie needs.

# Ric's Food Choices *(continued)*

## 9 – Pork Rinds

<b>Nutrition Facts</b>	
Serving Size 1 ounce (15g)	
Servings Per Container 7	
Amount Per Serving	
<b>Calories</b> 80	Calories from Fat 45
% Daily Value*	
<b>Total Fat</b> 5g	<b>8%</b>
Saturated Fat 1.5g	<b>8%</b>
Trans Fat 0g	
<b>Cholesterol</b> 20mg	<b>7%</b>
<b>Sodium</b> 300mg	<b>13%</b>
<b>Total Carbohydrate</b> 1g	<b>0%</b>
Dietary Fiber 0g	<b>0%</b>
Sugars 0g	
<b>Protein</b> 8g	
Vitamin A 2%	• Vitamin C 0%
Calcium 0%	• Iron 2%

## 10 – Crackers, Low Sodium

<b>Nutrition Facts</b>	
Serving Size 5 crackers	
Servings Per Container 32	
Amount Per Serving	
<b>Calories</b> 60	Calories from Fat 10
% Daily Value*	
<b>Total Fat</b> 1g	<b>2%</b>
Saturated Fat 0g	<b>0%</b>
Trans Fat 0g	
<b>Cholesterol</b> 0mg	<b>0%</b>
<b>Sodium</b> 35mg	<b>2%</b>
<b>Total Carbohydrate</b> 10g	<b>3%</b>
Dietary Fiber 1g	<b>4%</b>
Sugars 0g	
<b>Protein</b> 1g	
Vitamin A 0%	• Vitamin C 4%
Calcium 2%	• Iron 4%

Lower sodium choice



\* **Percent Daily Values** are based on a 2,000-calorie diet. Your Daily Values may be higher or lower depending on your calorie needs.



# Sodium in Foods

## Choose MORE Often



### Foods LOWER in Sodium

- Low-sodium sauces, such as light soy sauce
- Chicken and turkey (with skin removed)
- Fresh seafood or rinsed canned fish, such as tuna\* or sardines 
- Canned foods packed in water
- Low-sodium or reduced-sodium cheeses
- Low-salt chips, nuts, seeds, and crackers 
- Plain noodles (pasta) or steamed rice
- Homemade, low-sodium, or reduced-sodium soups
- Fresh, frozen, “no-salt-added,” or rinsed canned† vegetables
- Spices, herbs, and flavorings, such as bay leaf, green onion or onion powder, fresh garlic or garlic powder, saffron, ginger, lemongrass, parsley, tamarind leaf, vinegar, and watercress



## Choose LESS Often

### Foods HIGHER in Sodium



- *Balut* (fertilized egg)
- Smoked and cured meats, such as bacon, ham, sausage, hotdogs, and bologna 
- Canned seafood,\* such as tuna, sardines, and squid (that are not rinsed†)
- Canned meat, such as pork, corned beef, and sausage
- Canned foods packed in broth or salt†
- Most cheeses 
- Salty chips, crackers, nuts, and pretzels
- Quick-cooking rice and boxes of mixed rice, potatoes, or noodles
- Regular canned and instant soups
- Regular canned vegetables and pickled vegetables†
- Condiments and seasonings, such as soy sauce, monosodium glutamate (MSG), fish sauce, salted shrimp paste, salty, dried fish, dried salty shrimp, dried squid, ketchup, garlic salt, seasoning salt, bouillon cubes, and meat tenderizer 

\* Pregnant and nursing mothers: Talk to your health care provider to find out the types of fish you can eat that are lower in mercury.

† Rinse canned foods to reduce the sodium.



# Asin sa Mga Pagkain

## Piliin nang MAS Madalas ng Mga Pagkaing MAS MABABA ang Asin

- Mga sarsang mababa sa asin, tulad ng light na toyo
- Manok at pabo (na tinanggalan ng balat)
- Sariwang pagkaing dagat o binanlawang de latang isda, tulad ng *tuna*,\* o mga sardinas 
- Mga de latang pagkaing inihanda sa tubig
- Mga kesong mababa sa asin o bawas na asin
- Mga low-salt sitsirya, *nut*, buto, at biskwit 
- Walang sangkap na mga *noodle (pasta)* o sinaing na kanin
- Gawang-bahay, mababa sa asin, o mga sopas na bawas ang asin
- Sariwa, nai-freeze, “walang idinagdag na asin,” o mga binanlawang de latang† gulay
- Mga pampalasa, herbs at panimpla, tulad ng laurel, berdeng sibuyas o pulbos na sibuyas, sariwang bawang o pulbos na bawang, saffron, luya, tanglad, parsley, dahon ng sampalok, suka, at *watercress*



## Piliin nang HINDI Gaanong Madalas ang Mga Pagkaing MAS MATAAS sa Asin

- Balut (binugok na itlog)
- Pinausukan at ibinabad na mga karne tulad ng *bacon*, hamon, longanisa, mga *hotdog*, at *bologna* 
- De latang pagkaing dagat,\* tulad ng *tuna*, sardinas, at pusit (na hindi nababanlawan)†
- De latang karne, tulad ng baboy, karne norte, at longanisa
- Mga de latang pagkaing naipaketeng may *broth* o asin†
- Karamihang mga keso 
- Mga maaalat na sitsirya, biskwit, *nut*, at *pretzel*
- Mabilis malutong kanin at nakakahong may halong kanin, patatas, o pansit
- Regular na de lata at mga *instant* na sopas
- *Regular* na de latang mga gulay at inatsarang gulay†
- Mga sawsawan at pampalasa, tulad ng toyo, betsin (monosodium glutamate, MSG), patis (sawsawang gawa sa isda), alamang (pinaalat na hipong sawsawan), tuyo (maalat, tuyong isda), hibi (pinatuyong maalat na hipon) o pusit (pinatuyong pusit), *ketchup*, asing bawang, pampalasang asin, mga *bouillon cube*, at pampalambot ng karne 

\* Ang ilang mga uri ng isda ay naglalaman ng mataas na antas ng *mercury*. Dapat iwasan ang ganitong uri ng isda ng mga buntis na kababaihan at nagpapasung ina. Para sa karagdagang impormasyon, tingnan ang [www.cfsan.fda.gov/~dms/admeHg3.html](http://www.cfsan.fda.gov/~dms/admeHg3.html).

† Banlawan ang mga de latang pagkain upang mabawasan ang dami ng asin.

# Keep Your Heart in Mind: Lola's Tips To Eat Less Salt and Sodium

## Do you know your blood pressure numbers?

- A normal blood pressure is below **120/80 mmHg**.
- If your blood pressure is between **120/80** and **139/89 mmHg**, you have **prehypertension**. This means that you do not have high blood pressure yet, but you are likely to develop it if you don't change your health habits.
- If your blood pressure is **140/90 mmHg** or higher, you have high blood pressure or hypertension. High blood pressure does not go away by itself. Ask your doctor for help in lowering it.
- Ask your doctor what your blood pressure is. Keep track of each reading on your wallet card.



Write down your blood pressure reading here:



## Spice it up!

Discover how much flavor you can add by using spices and herbs.

Lola Idad has learned that it is not hard to get your family to eat less salt and sodium.

Look for low-sodium or salt-free seasonings and sauces in the grocery store.

My family got used to foods with less salt when I learned to use fewer high-sodium sauces and add less salt to my foods. Now, I make food taste good by using vinegar, bay leaf, green onion, garlic, ginger, saffron, tamarind, lemongrass, and even a dash of hot pepper. If I need some *patis* (fish sauce) or *bagoong alamang* (salted shrimp paste) for the sauce, then I use only a small amount of it.



(continued)

## Take the lead and try these simple changes:

### When Shopping

1. Buy fresh, frozen, or no-salt-added canned vegetables. Choose food packed in water instead of broth or salt.
2. Buy fresh garlic or garlic powder instead of garlic salt. 
3. Choose foods labeled “low sodium,” “lite,” “light,” “sodium free,” or “no salt added.”

### When Cooking

1. Slowly cut back on the amount of salt added when cooking until you do not use any.
2. Reduce the amount of high-sodium sauces, paste, and seasonings.
3. Add no salt to the water when cooking beans, rice, noodles, and vegetables.
4. Cut back on smoked, cured, and processed beef, seafood, poultry, and pork, such as ham, sausage, and corned beef.
5. Rinse all canned products to reduce the amount of sodium.

### When Eating

1. Fill the saltshaker with a mixture of herbs and spices instead of salt. 
2. Slowly cut back on the amount of salt added at the table until you don't use any.
3. Choose fruits and vegetables instead of salty snacks such as chips, fries, and pork rinds.
4. Cut back on sauces that have a lot of sodium, like *bagoong* (salted fish paste) and *patis* (fish sauce).



Ric has learned to control his high blood pressure. He takes his blood pressure pills with breakfast every morning to make sure that he does not forget to take them. He walks daily, has stopped smoking, and has found that food can still taste good with less salt and sodium.

**Make your personal pledge to do what Ric has done! Look at these examples:**

### Breakfast

Cook oatmeal with fat-free or low-fat (1%) milk or soy milk, raisins, cinnamon, and no salt.

### Lunch

Use leftover roast beef to make a sandwich instead of using lunch meats, or have beef with leftover rice and vegetables.



### Dinner



Make your own fish cardillo with vegetables and half the usual amount of salt.

### Snack

Eat a mango instead of salty chips.

**Write the changes you will try to make this week:**

---



---



---



---



---



---



---

**Your health and your family's health are priceless. Value it!**

# Tips for Taking Medicine for High Blood Pressure

1. Make sure you take your medicine every day as your doctor tells you, not only on the days when you do not feel well.
2. Tell the doctor the names of all other medicines, home remedies, herbs, or supplements you take. Bring everything with you when you have a doctor's appointment.
3. Tell the doctor right away if the medicine makes you feel strange or sick. Ask the doctor about changing the dosage or switching to another type of medicine.
4. Refill your prescription before you run out of medicine.
5. Have your blood pressure checked often to see if the medicine is working for you.
6. Do not stop taking your medicine if your blood pressure is okay. That means the medicine is working.



## Questions To Ask the Doctor:

**When the doctor gives you medicine for high blood pressure, ask:**

What is the name of the medicine(s)? \_\_\_\_\_

How much of each medicine should be taken? \_\_\_\_\_

When should the medicine(s) be taken? \_\_\_\_\_

What may be eaten or drunk with the medicine(s)? \_\_\_\_\_

Can other medicines be taken safely at the same time? \_\_\_\_\_

\_\_\_\_\_

What number should be called immediately if problems occur? \_\_\_\_\_

# Mga Payo sa Pag-inom ng Gamot para sa Mataas na Presyon ng Dugo

1. Tiyaking iinom ka ng gamot araw-araw tulad nang sinabi sa iyo ng iyong duktur, hindi lamang sa mga araw na hindi maganda ang iyong pakiramdam.
2. Sabihin sa duktur ang mga pangalan ng lahat ng iba pang mga gamot, panlunas sa bahay, *herb*, o pandagdag na iniinom mo. Dalhin ang lahat kapag mayroon kang appointment sa duktur.
3. Sabihin kaagad sa duktur kung may kakaiba kang nararamdaman sa iyong gamot o nagkakasakit ka. Hilingin sa duktur ang pagbabago o paglipat sa isa pang uri ng gamot.
4. Punang muli ang iyong reseta bago ka maubusan ng gamot.
5. Ipasuri ang iyong presyon ng dugo nang madalas upang makita kung umeepekto sa iyo ang gamot.
6. Huwag tumigil sa pag-inom ng iyong gamot kung maayos na ang iyong presyon ng dugo. Iyon ay nangangahulugang tumatalab ang gamot.



## Mga katanungang dapat itanong sa duktur:

**Kapag binigyan ka ng duktur ng gamot para sa mataas na presyon ng dugo, tanungin:**

Ano ang pangalan ng (mga) gamot? \_\_\_\_\_

Dami ng iinuming gamot: \_\_\_\_\_

Kailan dapat inumin ang (mga) gamot? \_\_\_\_\_

Ano ang dapat kainin o inumin kasabay ng (mga) gamot: \_\_\_\_\_

Ligtas bang inumin ang ibang mga gamot nang sabay-sabay? \_\_\_\_\_

\_\_\_\_\_

Anong numero ang kaagad na matatawagan sa sandaling magkaroon ng problema:

\_\_\_\_\_

# Use Herbs and Spices Instead of Salt

---

**Anise:** Use in breads, snacks, soups, stews, vegetables, meats, and poultry.

**Annatto Seeds:** Use in vegetables, meats, poultry, and rice.

**Basil:** Use in soups, salads, vegetables, meats, and fish.

**Bay Leaf:** Use in soups, stews, meats, poultry, seafood, and sauces.

**Chili Powder:** Use in soups, salads, vegetables, and fish.

**Cilantro:** Use in stews, meats, sauces, and rice.

**Cinnamon:** Use in breads, snacks, salads, and vegetables.

**Clove:** Use in breads, snacks, soups, salads, and vegetables.

**Dill Weed and Dill Seed:** Use in soups, salads, vegetables, and fish.

**Garlic:** Use in soups, stews, salads, vegetables, meats, poultry, seafood, and sauces.

**Ginger:** Use in soups, salads, vegetables, meats, and seafood.

**Green Onion/Onion Powder:** Use in soups, salads, meats, poultry, and seafood.

**Lemongrass:** Use in soups, stews, meats, poultry, seafood, and sauces.

**Marjoram:** Use in soups, salads, vegetables, meats, poultry, and seafood.

**Nutmeg:** Use in breads, snacks, vegetables, and meats.

**Oregano:** Use in soups, salads, vegetables, meats, and poultry.

**Parsley:** Use in salads, vegetables, meats, poultry, and seafood.

**Rosemary:** Use in salads, vegetables, meats, and seafood.

**Saffron:** Use in breads, snacks, soups, stews, poultry, seafood, sauces, and rice.

**Sage:** Use in soups, salads, vegetables, meats, and poultry.

**Tamarind:** Use in soups, poultry, sauces, and rice.

**Thyme:** Use in salads, vegetables, poultry, and fish.

**Vinegar:** Use in soups, salads, vegetables, meats, and poultry.

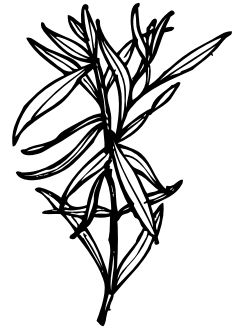

**Note:** To start, use small amounts of these herbs and spices to see if you like them.



# Fish Cardillo Recipe

This is a delicious low-cost recipe with low-sodium ingredients. Keep this recipe lower in fat by not adding meat fat (lard) or other fat.

1 pound (½ kg)	red snapper
4 teaspoons	corn oil for saute
¼ cup	flour
1 large	onion, sliced
3 or 4	medium-sized tomatoes, chopped
½ cup	egg whites, beaten
½ cup	water
A dash	ground pepper
15 stalks	green onions, chopped

1. Clean fish very well. Remove scales and gills, and wash thoroughly. Drain and set aside.
2. Slice the raw fish into six pieces.
3. Heat corn oil in frying pan.
4. Place the flour into a bowl or plastic bag. Place the raw fish in the flour and cover the outside of each fish with flour.
5. Saute fish until golden brown. Set aside on top of a paper towel.
6. Saute onion and tomatoes. Add ½ cup of water.
7. Add the beaten egg whites and fish. Cover and let it simmer for 5–10 minutes.
8. Season with ground pepper.
9. Sprinkle with chopped green onions.

## Quick Tip

This recipe is lower in salt and sodium than most because it uses:

- Fresh tomatoes instead of canned tomatoes
- Ground pepper and corn oil with no salt added
- Fresh onion and green onions
- Regular fish, not smoked or canned fish



Source: Philippine Heart Center's Healthy Heart Cookbook.

<b>Yield: 6 servings</b>	<b>Serving size:</b>
Calories	170
Total Fat	4 g
Saturated Fat	1 g
Cholesterol	45 mg
Sodium	115 mg
Total Fiber	3 g
Protein	20 g
Carbohydrates	13 g
Potassium	600 mg



# Lola's Life Lessons: Session 4

---

One of my favorite proverbs is:

*“Kung may itinanim, may aanihin.”*

Translation: “If you plant, you will harvest.”

Rewards will not come to you unless you work for them. Your mind may want to live a better, healthy life, but you need to make changes to reach that goal. My food choices were not always the best.

Of course, the Philippines is always in my heart. When I long for home, I remember the smells and foods of my province. But my favorite dishes have a lot of sodium. So Mila and I had to look for healthy and tasty ways to prepare Filipino dishes with less sodium. Now, I notice when something is too salty, and I do not even use the saltshaker at the table anymore! It takes time to change; you have to start with small steps first.

Look at my son Jose. He is a good nurse, but he is not a good patient. Jose did not try to control his high blood pressure, and he had a stroke! Do not wait for an emergency before you act. Take care of yourself and your family. Plan for the future. Love your life and make changes now. *Huli man daw at magaling, naihabol din.* It is never too late to offer anything that is good.

## **A Time To Reflect...**

What things keep you from using less sodium in your foods or choosing foods with less sodium? What changes can you make in your life to continue on your journey to heart health?

(Use this space to write down your thoughts for this week's session.)

# Pledge for Life! Session 4

---

Take the pledge for life with Lola Idad. Try to do at least one of these activities by yourself and/or share with others.

- Learn the stroke warning signs.
- Share the stroke survival tips with your family and friends.
- Know your family history of high blood pressure.
- Use Nutrition Facts labels to help you choose low-sodium food products.
- If available, choose low-sodium sauces and seasonings, or reduce the amount of sauces and seasonings that are high in sodium.
- Choose canned soups that are lower in sodium or prepare homemade soup without adding salt.
- Choose unsalted crackers for a snack instead of regular potato chips.
- Reduce the amount of salt you add to foods.
- Shop for fresh or frozen vegetables and fruits instead of canned vegetables and fruits.
- Try the fish cardillo recipe and other heart healthy recipes.
- Take the saltshaker off the table.
- If you use traditional Asian medicine or home remedies, share this information with your doctor.
- Other \_\_\_\_\_



# Be Heart Smart: Keep Your Cholesterol in Check

---

## Objectives

By the end of this session, group members will:

- Know what cholesterol is and how it affects the body.
  - Know what healthy cholesterol levels are.
  - Learn the steps they can take to lower their blood cholesterol levels.
- 

## Materials and Supplies

To conduct this session, you will need:

- “Healthy Heart, Healthy Family” manual and picture cards
- Blackboard and chalk or several large pieces of paper, markers, and tape
- How To Make an Artery Model (page 158)
- How To Explain the Artery Model (page 159)
- One empty paper towel roll
- Scissors
- Red construction paper and tape or red felt with sticky backing
- Red and yellow modeling clay

- Six paper plates
- Set of measuring spoons
- Can of shortening or lard
- Bottle of vegetable oil\*
- Choice of three of the following foods:\*

  - Coconut milk (canned)
  - Cream cheese
  - Snack cake (packaged cupcake)
  - Sardines, canned in olive oil (3.5 ounces)
  - Corned beef, canned
  - Guava, fresh
  - Soy milk, vanilla
  - Coconut oil

---

## Handouts

**Give each group member these handouts during this session:**

- *(Optional)* “List of Places Where Group Members Can Get Their Cholesterol Levels Checked”<sup>†</sup>
- “Take Action To Control Your Cholesterol” (pages 177–178)
- “Fats and Oils To Choose” (pages 179–180)

---

\* You can use pictures of these foods.

<sup>†</sup> Prepare this list before the session. You may find information at your local health department, hospital, or clinic.

- “Read the Nutrition Facts Label To Choose Foods Lower in Saturated Fat, *Trans* Fat, and Cholesterol” (page 181)
- “Mila’s Breakfast Choices” (pages 182–184)
- *(Optional)* “Mila Teaches Rose About Heart Healthy Cooking Role Play” (page 185)
- “Lola’s Tips To Eat Less Saturated Fat and Cholesterol” (page 186)
- “Guess the Fat Activity” (page 187)
- “Cooking With Less Saturated Fat” (pages 188–189)
- “Reduced-Fat *Adobong Manok* (Marinated Chicken) Recipe” (page 190)
- “Lola’s Life Lessons: Session 5” (page 191)
- “Pledge for Life! Session 5” (page 192)

---

## **Session Outline**

### **Introducing the Session**

1. Welcome
2. Review of Last Week’s Session
3. About This Session

### **Conducting the Session**

1. Facts About Blood Cholesterol
2. Cholesterol and Heart Disease
3. What Are Your Numbers?
  - A. What Are Triglycerides?
  - B. The Metabolic Syndrome and Your Health

4. Healthy Arteries Activity
5. Facts About Saturated Fat, *Trans* Fat, and Cholesterol
6. Nutrition Facts Label Activity—Fats
7. *(Optional)* Mila Teaches Rose About Heart Healthy Cooking Role Play
8. Guess the Fat Activity
9. Cooking With Less Saturated Fat Activity
10. Reduced-Fat *Adobong Manok* (Marinated Chicken) Recipe Activity

## **Review of Today’s Key Points**

### **Lola’s Life Lessons: A Time To Reflect**

### **Pledge for Life!**

### **Closing**

## Introducing the Session

---

### **1. Welcome**

- Welcome group members to the session.

### **2. Review of Last Week’s Session**

- Say:

Last week, we talked about salt and sodium.

■ Ask the questions below, and give the correct answers if group members do not.

**Q: Who remembers why you should try to limit the amount of salt and sodium in your diet?**

**A:** You should cut back on salt and sodium to help prevent or lower high blood pressure.

**Q: Does anyone remember some ways to reduce the amount of salt you eat?**

**A:** To cut back on salt and sodium, you can:

- Check the Nutrition Facts label to choose foods lower in sodium, such as light soy sauce (soy sauce with low sodium).
- Use fewer high-sodium sauces and ingredients, such as *patis* (fish sauce), *tuyo* (salty dried fish), *hibi* (salty, dried shrimp), and *bagoong* (fermented fish paste).
- Use herbs and spices instead of salt to season foods.
- Eat more fruits, vegetables, and fat-free or low-fat milk products for snacks.
- Choose low-sodium or unsalted nuts, pretzels, crackers, and popcorn.

■ Say:

At the end of our last session, you made a pledge to choose foods lower in salt and sodium. Share with the group what you did. What problems did you have? How did you solve them?



**Note:** Allow 5 minutes for group members to respond.

### 3. About This Session

■ Say:

Today we are going to talk about high blood cholesterol as a risk factor for heart disease. You will learn what you can do to keep your blood cholesterol levels low. We will also do some group activities that show how much saturated fat is in some foods and how to cook with less saturated fat. We will also learn how to keep *trans* fat and cholesterol intake low.



## ■ Say:

Last week, Lola’s family showed us that with courage and dedication, everyone can make changes so there will be less sodium in the foods they eat. Lola Idad encourages her family always to be thankful for and mindful of how they live their lives, including what they eat and how much. She often says, “*Bilisan mo ang gawain. Hinay-hinay sa pagkain.*” This means, “If it is work, do it fast; if it is food, eat it little by little.”

With Lola’s help, her family is now on the journey to heart health. In addition to watching their sodium intake, the de la Cruz family is lowering the amount of saturated fat they eat. Throughout this session, we will see examples of how the members of this family have made heart healthy changes to their eating habits.

# Conducting the Session

---

## 1. Facts About Blood Cholesterol

### ■ Say:

If a person’s blood cholesterol level is too high, he or she is more likely to get heart disease. Here are some facts about blood cholesterol:

- About 107 million American adults have total blood cholesterol levels that are above the desirable level. Of these, 38 million have high total blood cholesterol levels, meaning that they are at higher risk for clogged arteries and heart attack.
- Filipinas living in the United States have higher total cholesterol than Caucasian women.
- In the United States, Asians and Native Hawaiians and other Pacific Islanders are less likely than most ethnic groups to have their blood cholesterol checked.

## 2. Cholesterol and Heart Disease



**Note:** This section explains what cholesterol is, why the body needs it, how much cholesterol the body needs, and where cholesterol comes from.

■ **Say:**

Cholesterol is a soft, waxy, fat-like substance found in the body. Your body uses cholesterol to produce hormones and some vitamins.

■ **Show picture card 5.1.**

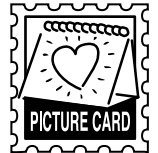

■ **Say:**

Cholesterol comes from two sources:

- Your liver makes all the cholesterol your body needs to keep you healthy. When cholesterol is produced, it goes into the bloodstream. The cholesterol that travels in your bloodstream is called blood cholesterol.
- Cholesterol also comes from the food you eat. Foods that come from animals have cholesterol. The cholesterol in the foods you eat is called dietary cholesterol. Other types of fat in foods that raise cholesterol are saturated fat and trans fat. Today we will learn how to lower your intake of these fats.

■ **Say:**

When too much cholesterol is in the blood, it increases the risk of a heart attack, stroke, and other health problems.

■ **Ask:**

Do you know anyone who has high blood cholesterol?



**Note:** Allow about 2 minutes for group members to respond.

■ **Say:**

Several things affect your blood cholesterol level. You cannot change some of them, such as your age, whether you are a man or a woman, or your family history (having family members with high blood cholesterol). But you can change the types of food you eat, the amount of physical activity you do, and your weight.

■ **Say:**

You can help prevent or lower high blood cholesterol by taking the following measures:

- Eating a heart healthy diet low in saturated fat, *trans* fat, and cholesterol.
- Being active every day.
- Maintaining a healthy weight.

■ **Show picture card 5.2.**

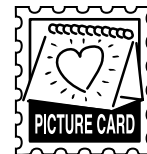

■ **Say:**

- Cholesterol travels through the bloodstream in the form of packages called “lipoproteins.” These packages are made of fat and protein.
- Low-density lipoproteins (or LDL) carry the cholesterol to your blood vessels, clogging them like rust in a pipe. This is why LDL cholesterol is often called the “bad” cholesterol.
- Cholesterol also travels in the blood in high-density lipoproteins (or HDL). HDL helps to remove cholesterol from your body, like removing rust from a pipe. This is why HDL cholesterol is often called the “good” cholesterol.
- Picture it this way:
  - The LDL person in the car (bad blood cholesterol) throws fat and cholesterol into the street (blood vessels).
  - The HDL person (good blood cholesterol) cleans up fat and cholesterol deposited by the LDL and puts it in the trash.
- Just remember, the “L” in LDL is for Lousy, and the Lower it is, the better. The “H” in HDL is for Healthy, and the Higher it is, the better.

### 3. What Are Your Numbers?

■ Show picture card 5.3.

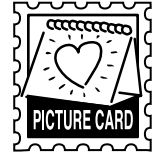

■ Ask:

How do you find out if you have high blood cholesterol levels or too much fat in your blood?

■ Say:

Your blood cholesterol levels are measured with a blood test. The test can be done at a doctor's office or at a cholesterol screening (for example, at a health fair).

- A lipid profile is the blood test done at the doctor's office. It is a complete test to measure the levels of each type of fat in the blood. It measures total cholesterol, LDL cholesterol, HDL cholesterol, and triglycerides. (We will talk about triglycerides later.) You have to fast for 12 hours before this test. This test is recommended for adults aged 20 or older.
- Screening sites may only test total cholesterol and sometimes HDL cholesterol. If you are an adult aged 20 or older, you may need to follow up with the doctor for a complete lipid profile.

■ Ask:

Have you ever had your blood cholesterol checked? If you have, do you remember your levels?

■ Give group members the "Take Action To Control Your Cholesterol" handout (pages 177–178). Review the cholesterol levels.



**Note:** If participants should ask, explain that cholesterol is measured in milligrams per deciliter (mg/dL).

■ Show picture card 5.4.

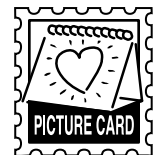

■ **Say:**

Here are what the **total cholesterol numbers** (mg/dL) mean:

**Less than 200 mg/dL**      **Desirable—Keep up the good work.**

---

**200–239 mg/dL**      **Borderline high**  
— Depending on your other risk factors, you may be at a higher risk for heart disease.  
— It is time to change your eating habits, increase your physical activity, and lose weight if overweight.

---

**240 or more mg/dL**      **High**  
— You are at a higher risk for clogged arteries and a heart attack.  
— Ask your doctor what your risk is for heart disease.

■ **Say:**

Here is what your HDL and LDL cholesterol numbers (mg/dL) mean:

**LDL (bad) cholesterol:      Keep it low!**

**Less than 100 mg/dL**      Desirable

**100–129 mg/dL**      Near desirable

**130–159 mg/dL**      Borderline high

**160 or more mg/dL**      High

---

**HDL (good) cholesterol:      The higher the better!**

**Keep it 40 mg/dL or higher.**

## More Information

### Heart Disease Risk and Your LDL Level

The goal for the LDL (bad cholesterol) level is different for each person. It depends on the risk factors you have. The number of risk factors—such as high blood pressure, low HDL, family history of heart disease, age and gender, and smoking—affects your LDL goal. The higher your LDL level and the more risk factors you have, the greater your chances of developing heart disease or having a heart attack. Your doctor can help you set a goal for your LDL level.

#### A. What Are Triglycerides?

■ **Say:**

Have any of you heard of triglycerides?



**Note:** Allow 2 minutes for group members to answer.

■ **Say:**

Triglycerides are another type of fat in the blood. When you eat too many calories, drink alcohol, or smoke, your body makes more triglycerides. When your triglycerides are high, it puts you at increased risk for heart disease.

■ **Say:**

A healthy triglyceride level is less than 150 mg/dL.

■ **Say:**

People with high triglycerides often have low HDL cholesterol (good cholesterol). People with diabetes can also have high triglycerides and low HDL cholesterol.

■ **Say:**

To have a healthy triglyceride level:

- Maintain a healthy weight or lose weight if you are overweight.
- Be physically active on all or most days of the week.
- Eat a heart healthy diet that is low in saturated fat, *trans* fat, and cholesterol.
- Limit candy, sweets, desserts, regular soda, juice, and other drinks high in sugar.
- Avoid smoking cigarettes and drinking alcohol. Smoking raises triglycerides and lowers HDL cholesterol. Excess alcohol also raises triglycerides.

**More Information**

**Here is what your triglyceride number (mg/dL) means:**

**Less than 150 mg/dL**    **Normal**

---

**150–199 mg/dL**            **Borderline high**  
You may be at an increased risk for heart disease. To lower your level, aim for a healthy weight, and be more physically active.

---

**200–499 mg/dL**            **High**  
Weight control and physical activity are very important to lower your level. Watch out for other heart disease risk factors such as overweight and obesity, diabetes, low HDL, and high blood pressure.

---

**500 or more mg/dL**        **Very high**  
See your doctor immediately! This level requires attention to prevent severe problems with your pancreas.

■ **Ask:**

Do you know what your triglyceride level is?



**Note:** Allow a few minutes for group members to respond.

- **Encourage** group members to make an appointment to have their cholesterol and triglycerides checked.
- **Tell** them to be sure to ask for their results and to write them down on their wallet cards.
- *(Optional)* **Give** group members a list of clinics and hospitals where they can get low-cost or free blood cholesterol testing.

## **B. The Metabolic Syndrome and Your Health**

■ **Say:**

- Now, we are going to learn about the metabolic syndrome. This disorder is made up of a group of five factors that affect heart health.
- Many people have this health problem and don't know they have it.

■ **Say:**

As I name the five factors that make up the metabolic syndrome, hold up your fist. Raise one finger for each risk factor you have.

■ **Show picture card 5.5.**

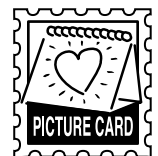

■ **Say:**

The five factors that make up the metabolic syndrome are:

- A low HDL (good) cholesterol level of below 50 for women and below 40 for men
- A triglyceride level of 150 mg/dL or more



- A blood pressure of 130/80\* mmHg or more (either number that is high counts as a risk)
- A waist measurement greater than 35 inches (88 centimeters) for women and greater than 40 inches (102 centimeters) for men
- Higher than normal fasting blood glucose (blood sugar) level of 100 or more

■ **Ask:**

How many fingers (risk factors) do you have raised?

■ **Say:**

- If you have three or more of these factors, you have the metabolic syndrome.
- The metabolic syndrome raises your chances of developing heart disease, diabetes, and stroke.
- People with the metabolic syndrome should lose weight and become physically active.

■ **Say:**

If you think you have the metabolic syndrome, talk to your doctor.

## 4. Healthy Arteries Activity



**Note:** This section uses the picture cards and an artery model to show how cholesterol can collect on the walls of the arteries and slow down and block the flow of blood. Blocked arteries can cause a heart attack or stroke.

■ **Show picture card 5.6.**

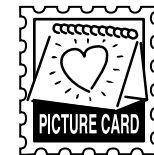

■ **Say:**

Blood flows freely to all cells of the body when arteries are normal and healthy.

---

\* The blood pressure level considered a factor for the metabolic syndrome is 130/80. This level is different from the level that defines high blood pressure, 140/90.

■ **Say:**

When your LDL cholesterol is too high, cholesterol may become trapped in the walls of your arteries, causing them to harden. The opening of the arteries can become clogged and narrowed.

■ **Show** the artery model.



**Note:** See page 159 for help explaining the artery model.

■ **Pass** the artery model around so group members can look at it closely.

■ **Ask:**

Have you ever seen someone fry food in lard and then dump the hot lard down the sink?

■ Allow a moment for group members to respond. Then **ask** them why they should not do this.

■ **Say:**

It is because the lard will clog the pipes. Foods high in saturated and *trans* fat will clog your pipes (arteries). So, we want to treat our bodies just as well as we treat our pipes.

# How To Make an Artery Model

## What you will need:

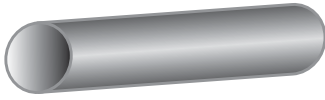

one empty paper towel roll

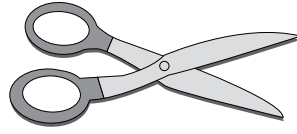

scissors

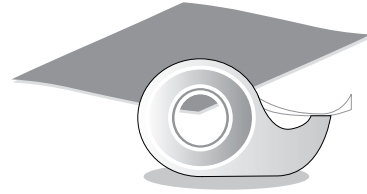

red construction paper  
and tape or red felt  
with sticky backing

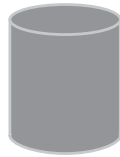

red modeling clay



yellow modeling clay

## What you need to do:

1. Cut construction paper or felt to fit around the outside of the roll.

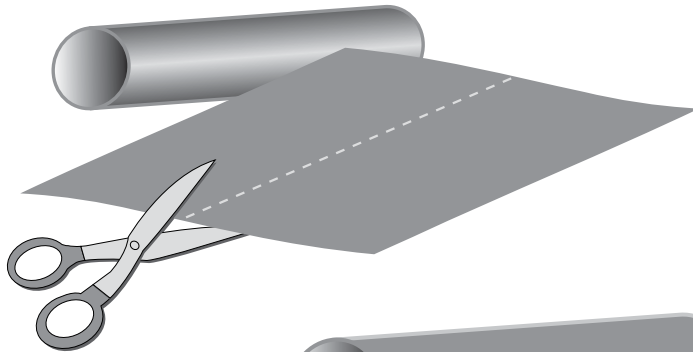

2. Tape construction paper or stick felt around the outside of the roll.

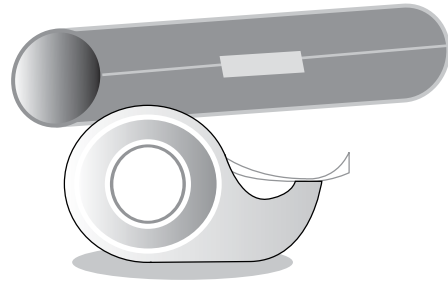

3. Roll out thin pieces of yellow and red clay into doughnut-shaped figures.

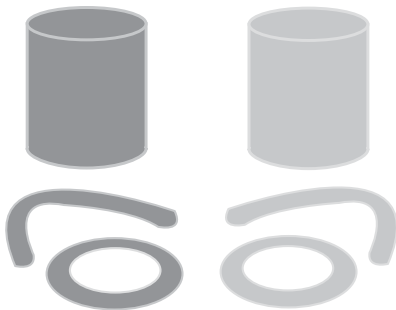

4. Make one small, round ball of the red clay.

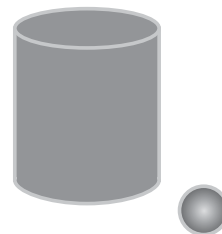

## How To Explain the Artery Model

1. Place the doughnut-shaped pieces of red clay on the outside edge of both ends of the roll.

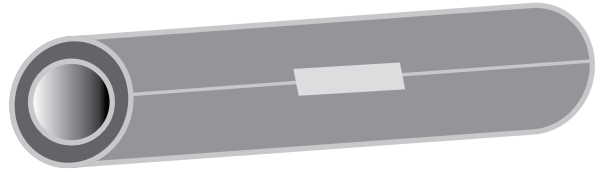

**Say:**

This is a healthy artery. The blood can flow through the opening easily.

2. Add pieces of the yellow clay to the inside edge of the red clay on one end of the roll.

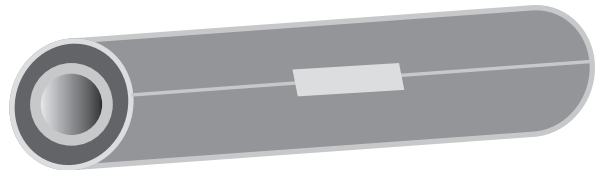

**Say:**

This is the beginning of a clogged artery. Cholesterol is starting to build up.

3. Continue to add pieces of yellow clay to this end of the roll. Add pieces until you almost fill in the opening completely.

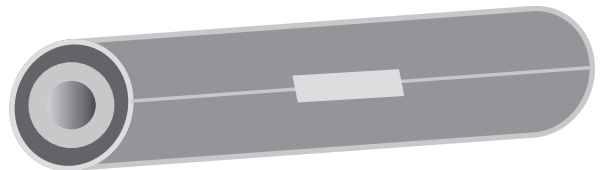

**Say:**

The opening of the clogged artery is getting smaller. Blood cannot flow through easily.

4. Put a red ball in the small opening that is left at the end of the roll.

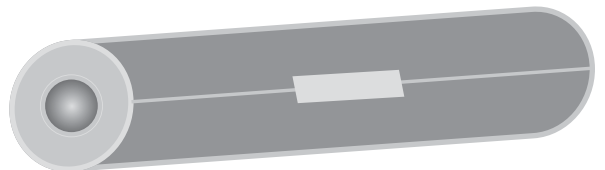

**Say:**

When the inside of an artery becomes narrowed, a blood clot may block an artery going to the heart. This may cause a heart attack. If the blood clot blocks an artery going to the brain, it may cause a stroke, or “brain attack.” Other problems caused by narrowed arteries are angina (chest pain) and poor blood circulation.

## 5. Facts About Saturated Fat, *Trans* Fat, and Cholesterol

### ■ Say:

Today, we will talk about the different types of fat and how they affect heart health.

- There are two main types of fat—saturated fat and unsaturated fat. Most foods contain some of both types. The saturated fat plus the unsaturated fat in food make up the total fat found in food.
- Saturated fat is found in foods that come from animals, such as high-fat meats, cheese, milk, and butter.
- Another type of fat called *trans* fat also raises cholesterol. *Trans* fat is found in a variety of baked goods (such as cookies, pies, and pastries), fried foods, stick margarine, and vegetable shortening. Choose light margarine (soft tub) instead of stick (hard) margarine, and look for *trans*-fat-free spreads in the grocery store.
- Eating too much saturated fat and *trans* fat will raise your blood cholesterol level more than anything else you eat. This will raise your chances of developing heart disease.

### ■ Say:

It is important to limit the amount of saturated fat and *trans* fat you eat, but you need some dietary fat to be healthy. Fats are necessary because they are used by the body to:

- Store and provide energy.
- Help carry vitamins A, D, E, and K throughout the body.

### ■ Ask:

What types of fat do you use to cook your food?



**Note:** Allow about 3 minutes for group members to answer. **Write** responses on the blackboard or on a large piece of paper taped to the wall.

■ **Show** group members a stick of butter (or a can of shortening or lard).

■ **Say:**

- Butter, shortening, and lard are examples of foods high in saturated fat.
- Saturated fat is usually solid at room temperature.
- Saturated fat is usually found in foods from animals.

■ **Show picture card 5.7.**

■ **Say:**

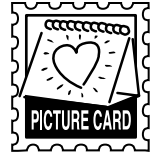

Here are some foods that are **high in saturated fat**:

- Whole milk and products made from whole milk (regular cheeses and cream cheese)
- Ice cream and whipped cream
- Fatty cuts of meat, such as chuck, regular ground beef, ribs, bacon, and sausage; canned meat, such as pork, corned beef, and vienna sausage
- Skin of chicken, turkey, and pig
- Butter
- Shortening
- Lard
- Oils such as coconut, palm, and palm kernel
- Doughnuts, pastries, cakes, and cookies
- Coconut milk

■ **Show picture card 5.8.**

■ **Say:**

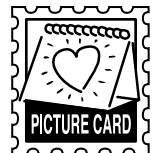

Here are foods that are **lower in saturated fat**:

- Lean meats such as loin, round, and extra lean ground beef
- Beans
- Tofu

- Fish and seafood\*
- Poultry without the skin
- Fat-free and low-fat milk, cheese, and yogurt
- Steamed rice
- Tub margarine
- Vegetable oil, such as canola, safflower, or sesame oil
- Fruits and vegetables

■ **Say:**

You want to limit the amount of saturated fat in your diet.

■ **Say:**

Even though vegetables and fruits are low in saturated fat, any plant food prepared with oil high in saturated fat (for example, eggplant or banana that is deep fried in coconut or palm oil) may raise your cholesterol level.

■ **Show** group members a bottle of vegetable oil.

■ **Say:**

Unsaturated fats are usually liquid at room temperature. As mentioned before, a few oils (coconut, palm, and palm kernel) are high in saturated fat.

■ *(Optional)* **Say:**

The types of unsaturated fats are polyunsaturated and monounsaturated.

---

\* Shrimp and crawfish have more cholesterol than most other types of fish and seafood, but they are lower in total fat and saturated fat than most meats and poultry.

## More Information

### Polyunsaturated fat is found in:

- Vegetable oils
  - Sesame oil
  - Corn oil
  - Sunflower oil
  - Soybean oil
- Some types of fish

### Monounsaturated fat is found in:

- Vegetable oils
  - Canola oil
  - Olive oil
  - Peanut oil
- Avocados
- Nuts

- Give group members the “Fats and Oils To Choose” handout (pages 179–180).



- Say:

The graph will quickly show you which products have the least saturated fat.

- Ask:

What four oils have the least saturated fat?

- Say:

Canola oil, safflower oil, sesame oil, and sunflower oil have the least saturated fat.

- Say:

Although polyunsaturated and monounsaturated fats are better for our health than saturated fat, we need to eat **less** of all types of fat. Fats are high in calories, and all fats have the same number of calories. Cutting back on calories helps us lose weight. We will talk about this in the next session.

- Show picture card 5.9.

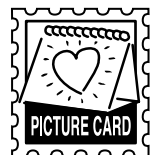

- Say:

Foods high in cholesterol can also raise your blood cholesterol and increase your risk of heart disease. Dietary cholesterol is found only in foods that come from animals. Foods that are highest in cholesterol are:



- Egg yolks
- Organ meats, such as liver, kidneys, tripe, heart, and tongue
- Shrimp

■ **Show picture card 5.10.**

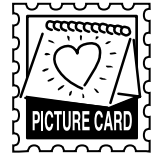

■ **Say:**

Foods that come from plants do not contain cholesterol. Foods that do not contain cholesterol include:

- |              |         |           |
|--------------|---------|-----------|
| • Fruits     | • Beans | • Rice    |
| • Vegetables | • Tofu  | • Grains  |
|              |         | • Cereals |

■ **Say:**

Plant foods that are prepared with animal products (for example, tofu fried in lard) have cholesterol.

■ **Say:**

Plant foods are generally lower in saturated fat and don't have cholesterol. They also contain a type of dietary fiber (soluble) that is beneficial for lowering cholesterol.

■ **Show picture card 5.11.**

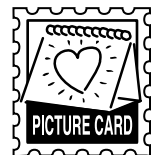

■ **Say:**

Soluble fiber is found in foods such as oats, fruits, barley, vegetables, and cooked dry beans and peas. So, this gives you one more reason to eat a variety of fruits and vegetables in addition to some whole-grain cereals such as oatmeal.

■ **Say:**

Fruits and vegetables that are a good source of soluble fiber are citrus fruits (oranges and grapefruit), guava, mango, apples, papaya, peaches, pears, pineapple, bananas, brussels sprouts, broccoli, and carrots. For great sources of soluble fiber, try to include a variety of cooked dry beans, cabbage, green beans, and oatmeal. Avoid canned beans that contain high amounts of salt and sodium. Prepare beans at home, flavoring them with garlic and spices instead of salt.

## 6. Nutrition Facts Label Activity—Fats

- **Give** group members the “Read the Nutrition Facts Label To Choose Foods Lower in Saturated Fat, *Trans* Fat, and Cholesterol!” handout (page 181).



- **Point** out on the Nutrition Facts label where to find saturated fat, *trans* fat, and cholesterol.



- **Show picture card 5.12.**

- **Say:**

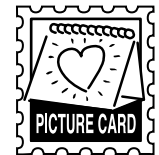

For a healthier heart, use the Nutrition Facts labels to choose foods with a lower Percent Daily Value for saturated fat and cholesterol. If you have high cholesterol, you may need to aim for a lower percent for saturated fat and cholesterol. Try to keep *trans* fat as low as possible. A doctor or registered dietitian can help you with this.

- **Show** group members where the Percent Daily Value is found on the Nutrition Facts label for whole milk.

- **Say:**

Look at the bottom of the handout. Look at the Percent Daily Value for whole milk and fat-free milk. Which is lower in saturated fat?

■ **Say:**

Fat-free milk is lower in saturated fat. One cup of fat-free milk has none of the Percent Daily Value of saturated fat. One cup of whole milk has 25 percent, or one-fourth, of the Percent Daily Value of saturated fat.

■ **Say:**

*Trans* fat is now listed on all Nutrition Facts labels. It is listed on a line below saturated fat, as seen here. Compare labels to choose the food lowest in saturated fat, *trans* fat, and cholesterol.

- **Give** group members the “Mila’s Breakfast Choices” handout (pages 182–184).



■ **Say:**

Now look at “Mila’s Breakfast Choices.” We are going to use the Nutrition Facts label to practice choosing foods that are lower in fat. First, I am going to tell you about a problem for many busy people. Then, we will use Nutrition Facts labels to find some solutions.

## Mila's Problem

Mila has little time in the morning to prepare breakfast. She often has *bibingka* (sweet rice cake) for breakfast, or leftovers, such as pork *longanisa* and fried rice. Look at the Nutrition Facts labels. Help Mila select some breakfast foods that are lower in saturated fat than her usual choices. It is also important to compare labels for *trans* fat and cholesterol amounts.



**Note:** The correct answer is underlined.

- Pork *longanisa*, sweet, or chicken *siopao* (steamed bun with chicken filling)?
- *Balut* (duck egg, raw) or hardboiled egg?
- Doughnut or *pan de sal* (Filipino roll)?
- Fruit danish or banana?
- Butter or light margarine (soft tub)?
- Fried rice or white, steamed rice?
- *Bibingka* (sweet rice cake with coconut milk) or plain oatmeal?
- Strawberry-flavored milk or vanilla soy milk?

■ **Ask** for a volunteer to describe:

- What he or she usually eats for breakfast
- Which foods are higher in fat
- What lower-fat foods can be chosen to replace them



**Note:** **Write** the answers on the blackboard or on a large piece of paper taped to the wall. Help the volunteer select some substitutes, if needed.

## 7. (Optional) Mila Teaches Rose About Heart Healthy Cooking Role Play



**Note:** Ask for two volunteers to be the actors in the role play. Give these two group members the “Mila Teaches Rose About Heart Healthy Cooking Role Play” handout (page 185). As the trainer, you can read the introduction. After the activity is completed, allow 5 minutes for discussion by asking the following questions.

### ■ Ask:

- What are some of the lessons we learned from this role play?
- Is there any part of the role play that you can use in your own life?

- Give group members the “Lola’s Tips To Eat Less Saturated Fat and Cholesterol” handout (page 186). Review the tips with the group.



## 8. Guess the Fat Activity

### Before the session



1. Buy a can of shortening. Also buy paper plates and cups and three foods from this list (or use pictures of the foods):
  - 2 tablespoons coconut milk
  - 2 tablespoons cream cheese
  - 2 snack cakes (packaged cupcakes)
  - Sardines, canned in olive oil (3.5 ounces)
  - 1 cup corned beef, canned
  - 1 guava, fresh
  - 8 ounces soy milk, vanilla
  - 2 tablespoons coconut oil
2. Write the name of each food you brought on a separate plate.
3. Look at the following chart. Find the amount of fat for each food you brought.

**Note:** You do not have to use all the food in the chart. Choose the foods that are eaten most often in your community.

Foods	Teaspoons of Fat (Grams of Fat) Note: 1 teaspoon looks like a single die.
1 ounce (about 2 tablespoons) coconut milk	About 2¼ teaspoons (9 grams)
1 ounce (about 2 tablespoons) cream cheese	About 2¼ teaspoons (9 g)
2 snack cakes (1 package cupcakes)	About 4½ teaspoons (18 g)
1 can sardines (3.75 ounces), packed in olive oil, drained	About 3¼ teaspoons (13 g)
2 ounces (1/6 can) corned beef	About 1¾ teaspoons (7 g)
1 mango, fresh	None
8 ounces soy milk, vanilla	About 1 teaspoon (3.5 g)
2 tablespoons coconut oil	About 7 teaspoons (27.2 g)

4. From the can of shortening, spoon the amount of fat listed on the chart onto the plate labeled for that food.
5. Take the remaining plates, and place each food item (or a picture of the food) on the separate plates.
6. Put all the plates away until you are ready to do this activity.

## Group Activity

### ■ Say:

We are going to play a guessing game that will help you learn about the total fat content of several foods. Learning which foods are higher in fat and how to replace them with foods that contain less fat will help you make healthier choices. Decreasing your total fat intake can help you reduce your saturated fat, *trans* fat, and calorie intake.



- **Give** group members the “Guess the Fat Activity” handout (page 187).



- **Show** group members the plates of foods (or pictures of food) that you prepared ahead of time.

- **Say:**

Guess how many teaspoons of fat are found in one serving of each of these foods. Write your guess on the “Guess the Fat Activity” handout.



**Note:** **Ask** group members to tell you the amount of fat they guessed for the first food item. After group members have shared their guesses, **tell** them the actual number of teaspoons of fat the food contains. **Tell** them to write this amount on their handout, too.

**Bring** out the plate of fat you made ahead of time for that food to show them how much it is. Then **do** this for the other foods.

- **Say:**

As you can see, it is easy to go over the limit for fat when we eat foods higher in fat, such as fried foods, some fast foods, hotdogs, coconut milk, chips, canned pork, corned beef, vienna sausages, *bibingka* (sweet rice cake), and ice cream. Eating foods lower in total fat will also help you reduce your saturated fat, *trans* fat, and cholesterol intake. To make it easier to cut back on fat, eat more foods that are lower in fat, such as fruits, vegetables, rice, whole-grain cereals and breads, beans, and fat-free or low-fat milk products.

- **Ask:**

How do you feel about the true amount of fat in the foods you guessed?



**Note:** Allow 3 to 5 minutes for group members to talk about their reactions.

- **Say:**

There are lower-fat substitutes for some of the higher-fat foods that we eat often.

- Review the following list.

<b>Foods</b>	<b>Lower-Fat Substitutions</b>
<b>Regular cheese</b>	Fat-free or low-fat cheese
<b>Evaporated whole milk</b>	Evaporated fat-free or low-fat milk or soy milk
<b>Lard or coconut oil</b>	Canola oil, safflower oil, or sesame oil
<b><i>Lumpiang shangai</i> (fried lumpia)</b>	<i>Lumpiang sariwa</i> (fresh lumpia)
<b>Vienna sausage</b>	Low-fat vienna sausage
<b>Sardines, canned in olive oil</b>	Sardines, canned in tomato sauce
<b>2 snack cakes</b>	Fresh fruit, such as pineapple or fruit cocktail, in juice
<b>12 ounces <i>halo halo</i> dessert (made with condensed milk)</b>	12 ounces <i>halo halo</i> dessert (made with fat-free or low-fat milk)

■ **Say:**

You can also reduce the amount of fat you eat simply by eating higher-fat foods less often or in smaller amounts.

## 9. Cooking With Less Saturated Fat Activity



**Note:** This section provides information that will help group members cut back on the amount of saturated fat in their diets. This activity will help them understand that they can cut back on the fat without giving up their traditional foods.

■ **Ask:**

Before we do this activity, can you tell me what you can do to cook with less saturated fat?



**Note:** Allow 3 minutes for group members to respond. **Write** their answers on the blackboard or on a large piece of paper taped to the wall.



■ **Say:**

This next activity shows how to prepare foods with less saturated fat.

- **Give** group members the “Cooking With Less Saturated Fat” handout (pages 188–189). **Review** each of the dishes listed. **Ask** volunteers to read each recipe out loud.



■ **Ask:**

What makes the recipes on the handout lower in saturated fat?



**Note:** Allow a few minutes for group members to respond.

- **Add** the following reasons if they are not mentioned:

- The pork is boiled instead of fried, and the fat is skimmed from the broth.
- The sauce is made with vegetables and herbs to provide additional flavoring.
- The potatoes are baked, not fried.
- The omelet recipe calls for just one egg, less oil, and low-fat milk. Vegetables add flavor and fiber.
- The potato salad is made with low-fat or fat-free mayonnaise. Kalamansi juice and diced vegetables are added for great flavor.
- The fruit shake is made with fat-free milk or yogurt instead of whole milk, coconut milk, or ice cream.

## 10. **Reduced-Fat *Adobong Manok* (Marinated Chicken) Recipe Activity**



- **Give** group members the “Reduced-Fat *Adobong Manok* Marinated Chicken Recipe” handout (page 190).



■ **Ask:**

How has saturated fat been reduced in this recipe?

■ Allow a moment for group members to respond. **Add** the following answers if they are not mentioned:

- The skin from the chicken has been removed.
- The chicken is boiled, not fried.
- The dish uses olive oil, which has less saturated fat than lard, palm oil, or coconut oil.
- The dish is flavored with vegetables, light soy sauce, and herbs, instead of salt.
- The dish is cooked and simmered slowly in moist heat instead of fried in fat.

■ **Say:**

Remember, foods that are lower in fat still contain calories. Check your portion sizes (including the side dishes, such as steamed rice). If you eat these foods in large quantities, you may gain weight.



**Note:** Ask if there are any questions. **Encourage** group members to try this recipe at home this week.

## Review of Today's Key Points

---

■ **Say:**

Let's review what you have learned today.

**What may cause your arteries to become clogged?**

- Cholesterol buildup will clog the arteries.

**What is considered a desirable total blood cholesterol level?**

- Less than 200 mg/dL

**What steps can you take to keep your cholesterol level low?**

- Eat foods lower in saturated fat, *trans* fat, and cholesterol.
- Maintain a healthy weight.
- Stay physically active.
- Eat a variety of whole grains, fruits, and vegetables.

**Can you name some foods that are high in saturated fat?**

- Lard, shortening, butter, fatty meats, poultry with skin, whole milk, coconut milk, and coconut oil

**What are some things you can do to make foods lower in fat?**

- Trim the fat from meat before cooking.
- Take the skin off poultry, and throw it away.
- Bake, steam, broil, or grill food instead of frying it.
- Do not reuse pan drippings from fatty cuts of meat to cook other foods.
- Cook the meat separately in a slow cooker (Crock-Pot<sup>®</sup>) so the fat can be removed.
- Skim the fat off soups before serving.

**Can you name some foods that are high in soluble fiber?**

- Oats, cooked dry beans, and peas
- Fruits and vegetables such as citrus fruits (oranges and grapefruit), guava, mango, apples, papaya, peaches, pineapple, bananas, brussels sprouts, broccoli, and carrots

# Lola's Life Lessons: A Time To Reflect

## ■ Say:

This week, Lola and her family remind us that the steps to a healthy heart also require discipline. Discipline means taking control of your eating habits. With courage and discipline, you can limit foods high in saturated fat, *trans* fat, and cholesterol.

- Give each group member the “Lola’s Life Lessons: Session 5” handout (page 191). Ask a volunteer to read the handout.



## ■ Say:

Please take a few moments to reflect on Lola’s advice and how it applies to your life. At the bottom of the handout, there is a space called “A Time To Reflect.” Use this section to record your feelings about this week’s session. Please write down your thoughts. Remember, this is for you and no one else.

- Give each group member 2 to 3 minutes to write down some thoughts.

## Pledge for Life!



## ■ Say:

You have learned a lot today about high blood cholesterol and how to eat less saturated fat, *trans* fat, and cholesterol. Now, let’s think about how you can apply what you have learned. Please think of one change you can make in your everyday life to keep your blood cholesterol in check.

## ■ Say:

Be specific about **what** you plan to do, **how** you plan to do it, and **when** you will start. Here are some examples:

- I will take the skin off the chicken, and I will throw the skin away.
- I will bake the fish instead of frying it in lard or grease.

- **Give** each group member the “Pledge for Life! Session 5” handout (page 192).



- **Say:**

Take the pledge for life with Lola Idad. Lola and her family have taken the pledge to practice heart healthy eating every day. Take a step toward eating less saturated fat, *trans* fat, and cholesterol. Pledge to do one thing on this list during the coming week.

- **Say:**

Would anyone like to share his or her pledge with the group?



**Note:** Write down pledge ideas on the blackboard or on a large piece of paper taped to the wall.



**Note:** If someone says they will use less oil in cooking, **ask** them to give you an example.

- **Say:**

We will discuss the results of your pledges next week. Remember to continue to work on your pledges to be physically active and eat less salt and sodium.

## Closing

---

- **Say:**

Thank you for coming today. What did you think of today’s session?



**Note:** Wait to see if group members respond.

- **Say:**

I am looking forward to seeing you at the next session. The next session will be about maintaining a healthy weight.



**Note for Educator:** Think about today’s session. What worked and what didn’t work? Have you decided to lower the amount of saturated fat in your diet and to know your numbers based on what was covered in today’s session?

# Take Action To Control Your Cholesterol

Do you know your blood cholesterol numbers?

## Get Checked

- A lipid profile is a blood test that measures your cholesterol and triglyceride levels.
- Adults aged 20 and older should have a lipid profile test at the doctor's office.

## Take Action

- Eating foods lower in saturated fat, *trans* fat, and cholesterol; doing physical activity; and losing weight if overweight can help you reduce your blood cholesterol level and prevent heart disease.

Here is what your blood cholesterol numbers mean:

## Total cholesterol

<b>Less than 200 mg/dL</b>	<b>Desirable.</b> Good for you! Keep up the good work!
<b>200–239 mg/dL</b>	<b>Borderline high.</b> Depending on your other risk factors, you may be at a higher risk for heart disease. It is time to change your eating habits, increase your physical activity, and lose weight if overweight.
<b>240 mg/dL or higher</b>	<b>High.</b> You are at a higher risk for clogged arteries and a heart attack. Ask your doctor what your risk is for heart disease.

## LDL (lousy, bad) cholesterol: Keep it low!

<b>Less than 100 mg/dL</b>	Optimal
<b>100–129 mg/dL</b>	Near optimal
<b>130–159 mg/dL</b>	Borderline high
<b>160 mg/dL or more</b>	High

## Write Your Numbers Here

Total Blood Cholesterol: \_\_\_\_\_

LDL: \_\_\_\_\_

HDL: \_\_\_\_\_

Triglycerides: \_\_\_\_\_

## HDL (healthy, good) cholesterol (mg/dL):

The higher the better! Keep it 40 mg/dL or higher.

**Triglycerides: Keep your triglycerides below 150 mg/dL.**



Lola and Mila have learned that it is not difficult to get their families to eat foods lower in saturated fat, *trans* fat, and cholesterol.

## How Lola and Mila switched their families from whole milk to fat-free milk

Lola and Mila slowly changed the milk their family drank from whole milk to fat-free milk. The first month, they served reduced-fat (2%) milk. During the next month, they served low-fat (1%) milk. Finally, they made the switch to fat-free milk. The change was so slow that they could not even taste the difference.

(continued)

## Try some of these simple changes

### When Shopping

1. Buy fat-free or low-fat (1%) milk and cheese.\*
2. Buy vegetable oil spray. Spray it on baking pans and skillet instead of using a lot of fat to grease pans.
3. Use the Nutrition Facts label to help you choose foods lower in saturated fat, *trans* fat, and cholesterol.

### When Cooking

1. Trim the fat from meat, and remove the skin and fat from chicken and pork before cooking.
2. Cook ground meat, drain the fat, and rinse with hot tap water. This removes half the fat. Do not reuse the fat to cook other food.
3. Cool broths, soups, and stews, and remove the layer of fat that rises to the top.
4. Use canola, safflower, or sesame oil instead of saturated fats and oils, such as coconut oil, shortening, and lard.

### When Eating

1. Use fat-free or low-fat salad dressing, mayonnaise, or cream cheese.
2. Use small amounts of tub margarine instead of butter.
3. Choose fruits and vegetables instead of high-fat foods such as chips or fries.

\* Or lactose-free products



Lola Idad has learned that eating foods high in saturated fat can raise her blood cholesterol level. So she has modified her favorite *bibingka* (sweet rice cake) recipe by using low-fat milk for the coconut milk and low-fat tub margarine for the butter. Now the *bibingka* is lower in saturated fat, *trans* fat, and cholesterol, and it still tastes great.

## Make your personal pledge to do what Lola has done! Look at these examples:



### Breakfast

Use fat-free or low-fat milk in coffee or oatmeal.

### Lunch

Use leftover roast beef to make a sandwich on whole-grain bread. Eat it with some raw carrots and an orange for dessert.



### Dinner

Broil the chicken in olive oil, garlic, and onions. Remove and throw away the skin before cooking.

### Snack

Eat fresh guava instead of ice cream.

## Write the changes you will try to make this week:

---



---



---



---

**The health of you and your family is priceless. Value it!**

# Fats and Oils To Choose

When you do use fats and oils, choose those with less saturated fat.

Lower in Saturated Fat— Choose <b>More</b> Often	Higher in Saturated Fat— Choose <b>Less</b> Often
<ul style="list-style-type: none"> <li>♥ Canola, corn, olive, sesame, soybean, and sunflower oils</li> <li>♥ Tub margarine (especially light margarine)</li> </ul>	<ul style="list-style-type: none"> <li>• Butter</li> <li>• Solid shortening</li> <li>• Lard</li> <li>• Fatback</li> <li>• Stick margarine</li> </ul>

## Read the Nutrition Facts Label To Choose Foods Lower in Saturated Fat, *Trans* Fat, and Cholesterol!

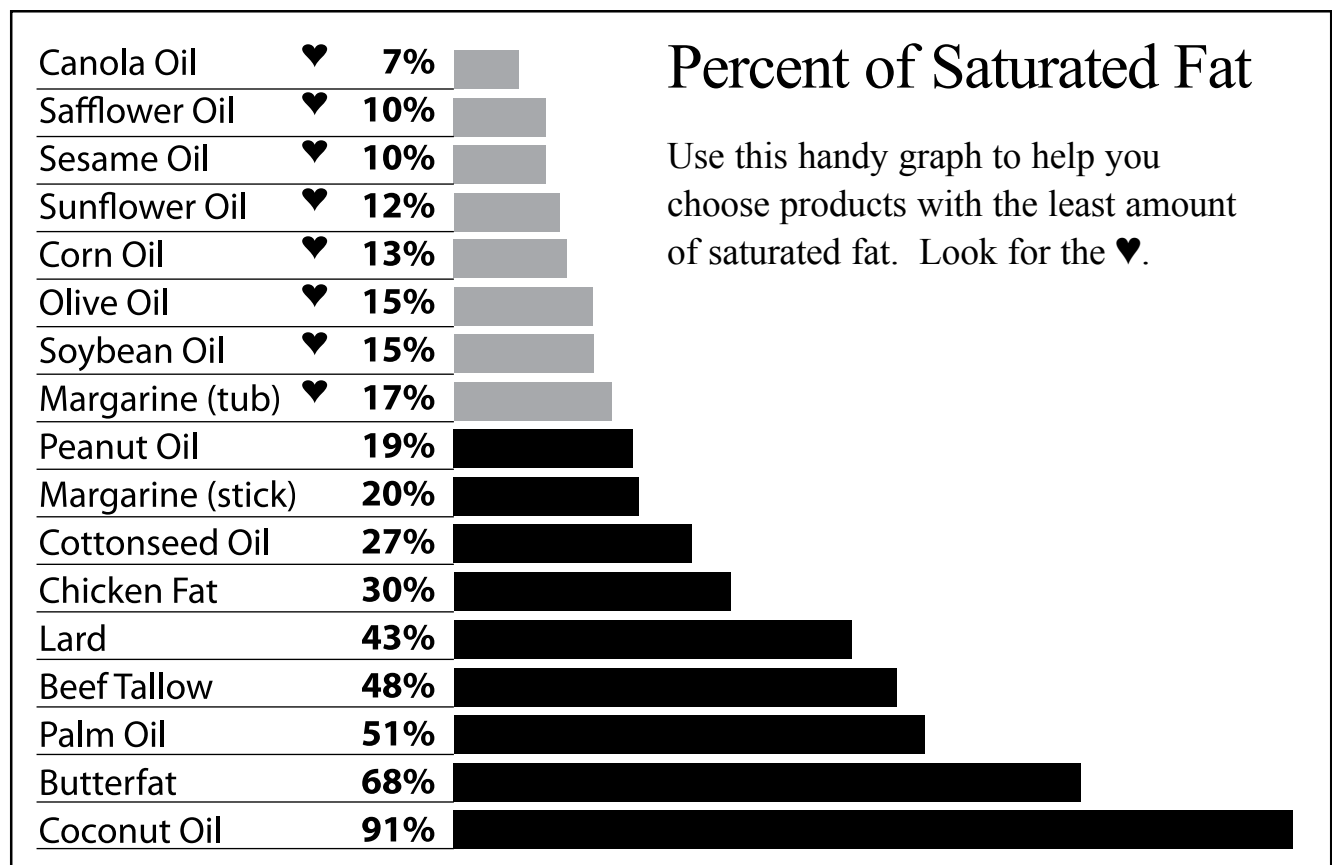

Source: Adapted from Canola Council of Canada, “Canola Oil Dietary Fat” ([www.canola-council.org/PDF/dietarychart.pdf#zoom=100](http://www.canola-council.org/PDF/dietarychart.pdf#zoom=100)), July 19, 2007.



# Mga Dapat Piliing Mga Fats at Oils

Kapag gumagamit ka ng mga fats at oils, piliin ang mga may mas mababang *saturated fat*.

**Mas mababa sa *Saturated Fat*—  
Piliin nang Mas Madalas**

- ♥ *Canola, corn, olive, safflower, soybean, sesame, at sunflower oils*
- ♥ *Tub margarine* (lalo na ang *light margarine*)

**Mas mataas sa *Saturated Fat*—  
Piliin nang Mas Kaunti**

- Mantekilya
- Solidong *shortening*
- Lard (taba ng hayop)
- *Stick margarine*

Basahin ang *Label* ng Mga Katotohanan sa Nutrisyon Upang Makapili ng Mga Pagkaing Mas Mababa sa *Saturated Fat*, *Trans Fat*, at Kolesterol

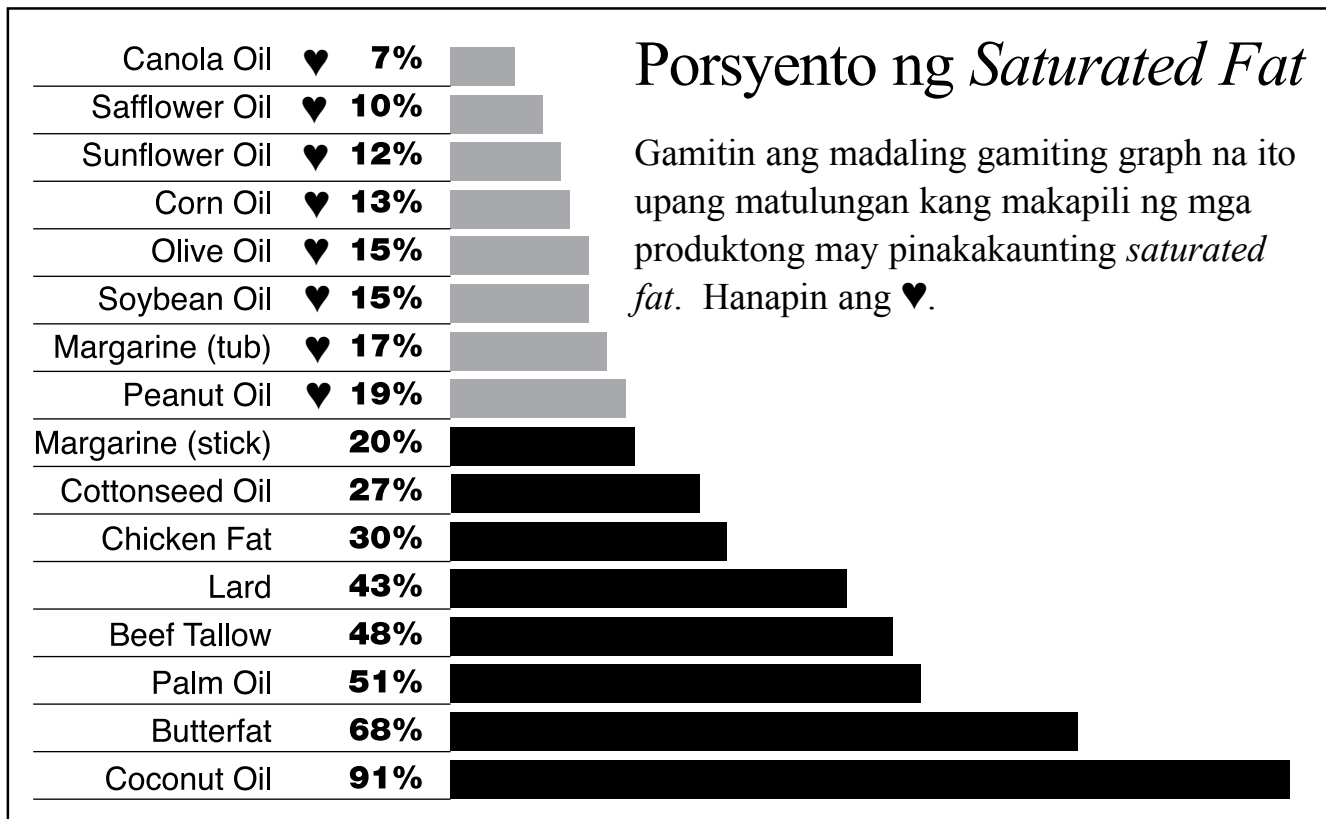

Mapagkukunan: Alinsunod sa Canola Council ng Canada, “Canola Oil Dietary Fat” ([www.canola-council.org/PDF/dietarychart.pdf#zoom=100](http://www.canola-council.org/PDF/dietarychart.pdf#zoom=100), Hulyo 19, 2007.



# Read the Nutrition Facts Label To Choose Foods Lower in Saturated Fat, *Trans* Fat, and Cholesterol

Nutrition Facts labels tell you what you need to know to choose foods that are lower in saturated fat, *trans* fat, and cholesterol. Here is a Nutrition Facts label for a carton of whole milk.

## The label tells you:

### Amount Per Serving

The nutrient amounts are for one serving. So, if you have more or less than one serving, you need to add the corresponding nutrient amounts. For example, if you drink 2 cups of whole milk, you are drinking two servings. You would need to double the amount of calories, saturated fat, *trans* fat, and cholesterol.

### Nutrients

Here are the amounts of saturated fat, *trans* fat, and cholesterol in one serving. These amounts are given in grams (g) or milligrams (mg).

## Whole Milk

Nutrition Facts	
Serving Size 1 cup (8 fl. oz.)	
Servings Per Container 8	
Amount Per Serving	
Calories 150	Calories from Fat 70
% Daily Value*	
<b>Total Fat</b> 8g	<b>12%</b>
Saturated Fat 5g	<b>25%</b>
<i>Trans</i> Fat 0g	
<b>Cholesterol</b> 35mg	<b>12%</b>
<b>Sodium</b> 125mg	<b>5%</b>
<b>Total Carbohydrate</b> 12g	<b>4%</b>
Dietary Fiber 0g	<b>0%</b>
Sugars 11g	
<b>Protein</b> 8g	
Vitamin A 35%	Vitamin C 4%
Calcium 2%	Iron 0% • Vitamin D 25%

### Serving Size and Number of Servings

The serving size is 8 fluid ounces (1 cup). There are eight servings in this carton.

### Percent Daily Value

The Percent Daily Value helps you compare products. Choose products with the lowest Percent Daily Value for saturated fat and cholesterol. If you have high blood cholesterol, you should eat even less saturated fat, *trans* fat, and cholesterol. A doctor or registered dietitian can help you with this.

## The Choice Is Yours—Compare!

### Which one would you choose?

Except for calories and saturated fat, fat-free milk has all the nutrients of whole milk, including the calcium. That makes fat-free milk a better choice! Read Nutrition Facts labels, and choose products to keep your heart strong.

Calories 150	Calories from Fat 70
% Daily Value*	
<b>Total Fat</b> 8g	<b>12%</b>
Saturated Fat 5g	<b>25%</b>
<i>Trans</i> Fat 0g	
<b>Cholesterol</b> 35mg	<b>12%</b>
<b>Sodium</b> 125mg	<b>5%</b>

Calories 90	Calories from Fat 0
% Daily Value*	
<b>Total Fat</b> 0g	<b>0%</b>
Saturated Fat 0g	<b>0%</b>
<i>Trans</i> Fat 0g	
<b>Cholesterol</b> 0mg	<b>0%</b>
<b>Sodium</b> 125mg	<b>5%</b>

### Whole Milk

One cup of whole milk has 25 percent of the Daily Value of saturated fat. This is one-fourth of the total amount of saturated fat that you should have in 1 day. This is too much!

### Fat-Free Milk

One cup of fat-free milk has no saturated fat. You can learn a lot from a Nutrition Facts label.

\*Percent Daily Values are based on a 2,000-calorie diet. Your Daily Values may be higher or lower depending on your calorie needs.

# Mila's Breakfast Choices



Mila has little time in the morning to prepare breakfast. She often has *bibingka* (sweet rice cake) for breakfast, or leftovers such as pork *longanisa* and fried rice.

Look at the Nutrition Facts labels. Help Mila select some breakfast foods that are lower in saturated fat than her usual choices.

Which should she choose? Write the number of your choice for each pair in the space between the labels.

## 1 – Pork *Longanisa*, Sweet

Nutrition Facts	
Serving Size 2 links (66g)	
Servings Per Container 6	
Amount Per Serving	
<b>Calories</b> 210	Calories from Fat 150
% Daily Value*	
<b>Total Fat</b> 27g	<b>41%</b>
Saturated Fat 6g	30%
Trans Fat 0g	
<b>Cholesterol</b> 40mg	<b>13%</b>
<b>Sodium</b> 320mg	<b>13%</b>
<b>Total Carbohydrate</b> 6g	<b>2%</b>
Dietary Fiber 0g	0%
Sugars 5g	
<b>Protein</b> 8g	
Vitamin A 4%	Vitamin C 2%
Calcium 0%	Iron 4%

## 2 – Chicken *Siopao* (Steamed Bun With Chicken filling)

Nutrition Facts	
Serving Size 114g	
Servings Per Container 6	
Amount Per Serving	
<b>Calories</b> 300	Calories from Fat 30
% Daily Value*	
<b>Total Fat</b> 4g	<b>6%</b>
Saturated Fat 1g	5%
Trans Fat 0g	
<b>Cholesterol</b> 25mg	<b>8%</b>
<b>Sodium</b> 260mg	<b>11%</b>
<b>Total Carbohydrate</b> 52g	<b>17%</b>
Dietary Fiber 2g	8%
Sugars 11g	
<b>Protein</b> 12g	
Vitamin A 100%	Vitamin C 0%
Calcium 2%	Iron 6%

Lower saturated fat choice

## 3 – *Balut* (Duck Egg, Raw)

Nutrition Facts	
Serving Size 1 egg (70g)	
Servings Per Container 1	
Amount Per Serving	
<b>Calories</b> 130	Calories from Fat 90
% Daily Value*	
<b>Total Fat</b> 10g	<b>15%</b>
Saturated Fat 3g	15%
Trans Fat 0g	
<b>Cholesterol</b> 620mg	<b>206%</b>
<b>Sodium</b> 100mg	<b>4%</b>
<b>Total Carbohydrate</b> 1g	<b>0%</b>
Dietary Fiber 0g	0%
Sugars 1g	
<b>Protein</b> 2g	
Vitamin A 9%	Vitamin C 0%
Calcium 4%	Iron 15%

## 4 – Hard Boiled Egg

Nutrition Facts	
Serving Size 1 egg	
Servings Per Container 1	
Amount Per Serving	
<b>Calories</b> 80	Calories from Fat 50
% Daily Value*	
<b>Total Fat</b> 5g	<b>8%</b>
Saturated Fat 2g	10%
Trans Fat 0g	
<b>Cholesterol</b> 210mg	<b>71%</b>
<b>Sodium</b> 60mg	<b>3%</b>
<b>Total Carbohydrate</b> 0g	<b>0%</b>
Dietary Fiber 0g	0%
Sugars 0g	
<b>Protein</b> 6g	
Vitamin A 6%	Vitamin C 0%
Calcium 2%	Iron 0%

Lower saturated fat choice

\* Percent Daily Values are based on a 2,000-calorie diet. Your Daily Values may be higher or lower depending on your calorie needs.

# Mila's Breakfast Choices *(continued)*

## 5 – Fruit Danish

Nutrition Facts	
Serving Size 1/8 (57g)	
Servings Per Container 8	
Amount Per Serving	
<b>Calories</b> 160	Calories from Fat 72
% Daily Value*	
<b>Total Fat</b> 8g	<b>12%</b>
Saturated Fat 1.5g	<b>8%</b>
Trans Fat 1g	
<b>Cholesterol</b> 5mg	<b>2%</b>
<b>Sodium</b> 210mg	<b>9%</b>
<b>Total Carbohydrate</b> 24g	<b>8%</b>
Dietary Fiber 0g	<b>0%</b>
Sugars 13g	
<b>Protein</b> 2g	
Vitamin A 0%	• Vitamin C 4%
Calcium 10%	• Iron 2%

Lower  
saturated  
fat choice

## 6 – Banana

Nutrition Facts	
Serving Size 1 medium (126g)	
Servings Per Container 1	
Amount Per Serving	
<b>Calories</b> 110	Calories from Fat 0
% Daily Value*	
<b>Total Fat</b> 0g	<b>0%</b>
Saturated Fat 0g	<b>0%</b>
Trans Fat 0g	
<b>Cholesterol</b> 0mg	<b>0%</b>
<b>Sodium</b> 0mg	<b>0%</b>
<b>Total Carbohydrate</b> 29g	<b>10%</b>
Dietary Fiber 1g	<b>4%</b>
Sugars 21g	
<b>Protein</b> 1g	
Vitamin A 0%	• Vitamin C 0%
Calcium 0%	• Iron 0%

## 7 – Butter

Nutrition Facts	
Serving Size 1Tbsp (14g)	
Servings Per Container 32	
Amount Per Serving	
<b>Calories</b> 100	Calories from Fat 100
% Daily Value*	
<b>Total Fat</b> 11g	<b>17%</b>
Saturated Fat 8g	<b>40%</b>
Trans Fat 0g	
<b>Cholesterol</b> 30mg	<b>10%</b>
<b>Sodium</b> 85mg	<b>4%</b>
<b>Total Carbohydrate</b> 0g	<b>0%</b>
Dietary Fiber 0g	<b>0%</b>
Sugars 0g	
<b>Protein</b> 0g	
Vitamin A 8%	• Vitamin C 0%
Calcium 0%	• Iron 0%

Lower  
saturated  
fat choice

## 8 – Light Margarine (Soft Tub)

Nutrition Facts	
Serving Size 1Tbsp (14g)	
Servings Per Container 80	
Amount Per Serving	
<b>Calories</b> 50	Calories from Fat 50
% Daily Value*	
<b>Total Fat</b> 6g	<b>9%</b>
Saturated Fat 1.5g	<b>8%</b>
Trans Fat 0g	
<b>Cholesterol</b> 0mg	<b>0%</b>
<b>Sodium</b> 55mg	<b>2%</b>
<b>Total Carbohydrate</b> 0g	<b>0%</b>
Dietary Fiber 0g	<b>0%</b>
Sugars 0g	
<b>Protein</b> 0g	
Vitamin A 10%	• Vitamin C 0%
Calcium 0%	• Iron 0%

\* **Percent Daily Values** are based on a 2,000-calorie diet. Your Daily Values may be higher or lower depending on your calorie needs.

# Mila's Breakfast Choices *(continued)*

## 9 – Fried Rice

<b>Nutrition Facts</b>	
Serving Size 1 cup (185g)	
Servings Per Container 4	
Amount Per Serving	
<b>Calories</b> 450	Calories from Fat 80
% Daily Value*	
<b>Total Fat</b> 9g	<b>14%</b>
Saturated Fat 5g	<b>25%</b>
Trans Fat 0g	
<b>Cholesterol</b> 121mg	<b>120%</b>
<b>Sodium</b> 1082mg	<b>45%</b>
<b>Total Carbohydrate</b> 80g	<b>27%</b>
Dietary Fiber 2g	<b>8%</b>
Sugars 1g	
<b>Protein</b> 12g	
Vitamin A 6%	• Vitamin C 1%
Calcium 2%	• Iron 28%

## 10 – White Rice, Steamed

<b>Nutrition Facts</b>	
Serving Size 1 cup (158g)	
Servings Per Container 4	
Amount Per Serving	
<b>Calories</b> 210	Calories from Fat 5
% Daily Value*	
<b>Total Fat</b> 0g	<b>0%</b>
Saturated Fat 0g	<b>0%</b>
Trans Fat 0g	
<b>Cholesterol</b> 0mg	<b>0%</b>
<b>Sodium</b> 2mg	<b>0%</b>
<b>Total Carbohydrate</b> 45g	<b>15%</b>
Dietary Fiber 1g	<b>4%</b>
Sugars 1g	
<b>Protein</b> 6g	
Vitamin A 0%	• Vitamin C 0%
Calcium 2%	• Iron 11%

Lower saturated fat choice

## 11 – Strawberry-flavored Milk

<b>Nutrition Facts</b>	
Serving Size 8 fl oz	
Servings Per Container 4	
Amount Per Serving	
<b>Calories</b> 230	Calories from Fat 80
% Daily Value*	
<b>Total Fat</b> 9g	<b>14%</b>
Saturated Fat 5g	<b>25%</b>
Trans Fat 0g	
<b>Cholesterol</b> 30mg	<b>10%</b>
<b>Sodium</b> 100mg	<b>4%</b>
<b>Total Carbohydrate</b> 31g	<b>10%</b>
Dietary Fiber 0g	<b>0%</b>
Sugars 30g	
<b>Protein</b> 7g	
Vitamin A 6%	• Vitamin C 0%
Calcium 25%	• Iron 0%

## 12 – Soy Milk, Vanilla

<b>Nutrition Facts</b>	
Serving Size 8 fl oz	
Servings Per Container 4	
Amount Per Serving	
<b>Calories</b> 90	Calories from Fat 30
% Daily Value*	
<b>Total Fat</b> 4g	<b>6%</b>
Saturated Fat 1g	<b>5%</b>
Trans Fat 0g	
<b>Cholesterol</b> 0mg	<b>0%</b>
<b>Sodium</b> 160mg	<b>7%</b>
<b>Total Carbohydrate</b> 11g	<b>4%</b>
Dietary Fiber 2g	<b>8%</b>
Sugars 6g	
<b>Protein</b> 6g	
Vitamin A 10%	• Vitamin C 0%
Calcium 30%	• Iron 8%

Lower saturated fat choice

\* Percent Daily Values are based on a 2,000-calorie diet. Your Daily Values may be higher or lower depending on your calorie needs.

# Mila Teaches Rose About Heart Healthy Cooking Role Play

---

Rose and her family moved to the United States a few years ago. Rose often looks to her sister-in-law, Mila, for advice.

**Rose:** *Ate*,\* that fish *cardillo* dish you made last week was so good! Since the stroke, Jose has been trying to be really careful with what he eats, but it has been hard. He does not believe that something healthy can taste good! Can you teach me how to make something that tastes good and is healthy?

**Mila:** Sure! Mama and I tried many different recipes. Trying to eat heart healthy was a difficult change for us all. And Jose is hardheaded like my Cesar. They both think that Filipino dishes can only be made the way they make them back home. But now, Cesar and the kids hardly notice the difference.

**Rose:** So, what kind of changes did you make?

**Mila:** Well, it was very hard to stop using the fat left in the pan when we cook meat. Back home, everyone saves and reuses that fat for everything. It is a good way to save money and can make dishes more flavorful. But now I drain off the fat when I cook meat, and throw it away, because it is high in saturated fat. If a dish needs fat, I just use a little bit of canola oil and flavor it with herbs and spices. Try it!

**Rose:** Oh, I think they will notice the difference!

**Mila:** You will be surprised. Just make the changes little by little. Your family will like the dishes as much as ever.

**Rose:** So, *Ate*, when is my first cooking lesson?

**Mila:** Whenever you want, Rose! You know, I am always here for you.

\* *Ate* means “elder sister” in Tagalog. It is common to address an older woman for whom you have a lot of respect as “*Ate*,” whether she is blood related or not.

# Lola's Tips To Eat Less Saturated Fat and Cholesterol

---

## Healthy Cooking Tips

- Bake, steam, broil, or grill food instead of frying.
- Remove the skin from chicken and other poultry before cooking.
- Cool broth, soups, and stews, and skim off fat before serving.
- Use oils low in saturated fat, such as canola, safflower, and sesame oil.
- Trim visible fat from pork and other fatty meats before cooking.
- Use the slow cooker (Crock-Pot<sup>®</sup>) to cook meats and stews, and skim the fat off the surface before serving.
- Flavor the food with vegetables, herbs, and spices—not with fat!

### Choose **MORE** Often

---

- Chicken—breast, drumstick (skin removed before cooking)
- Pork—ears, neck bone, feet, ham hocks
- Beef—tripe
- Fish and seafood\*
- Lean cuts of meat (such as round, sirloin, and loin)
- Egg whites
- Vegetable oil (such as canola, safflower, or sesame oil)

### Choose **LESS** Often

---

- Chicken—wing, thigh (skin on while cooking)
- Pork—hog maws, luncheon meat, vienna sausage, bacon, ribs
- Fatty cuts of meat
- Beef oxtail
- Organ meats (such as liver, kidney, brains, and tongue)
- Egg yolks
- Lard, butter, shortening









\* Shrimp and crawfish have more cholesterol than most other types of fish and seafood. But they are lower in total fat and saturated fat than most meats and poultry.

Source: Adapted from *Be Heart Smart! Eat Foods Lower in Saturated Fat and Cholesterol*, NHLBI, and <http://www.americanheart.org/presenter.jhtml?identifier=516>.

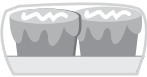
# Guess the Fat Activity

Try to guess how much fat (in teaspoons) is found in each food.

Write your answers on the “My Guess” line.

		Teaspoons of Fat	
Food		My Guess	True Amount
	2 tablespoons coconut milk	_____	_____
	1 tablespoon cream cheese	_____	_____
	2 snack cakes (1 package cupcakes)	_____	_____
	Sardines in olive oil, canned (1 package = about $\frac{1}{3}$ cup)	_____	_____
	2 ounces corned beef, canned (2 ounces = $\frac{1}{6}$ canned corned beef)	_____	_____
	1 guava, fresh	_____	_____
	2 tablespoons coconut oil	_____	_____
	8 ounces soy milk, vanilla	_____	_____



# Cooking With Less Saturated Fat

---

## Pork Puchero

---

1. Simmer 2 pounds cubed pork (0.9 kg) in a large pot filled with boiling water. Reduce heat, and simmer on low heat for at least 2 hours so the meat can achieve the right tenderness. Remove the meat from the pot. Skim fat from the water (broth). Add  $\frac{1}{4}$  pound (0.1 kg) green beans, 2 potatoes (cubed), and 1 head of cabbage (sliced) to the broth.
2. In a medium saucepan, saute 1 chopped celery stalk, 1 chopped green pepper, 4 chopped green onions, and 2 cloves crushed garlic in 1 tablespoon vegetable oil.
3. Add  $\frac{1}{2}$  cup low-sodium tomato sauce. Simmer for a few minutes so the flavors can mix. Add some pork broth from the previous pot and 1 cup chickpeas (garbanzo beans).
4. Serve steamed white or brown rice in deep dishes. Place a scoop of the pork and vegetables over the rice and pour the tomato sauce on top.



Adapted from [http://www.filipinorecipe.com/meat\\_and\\_fish\\_dishes/beef\\_puchero.htm](http://www.filipinorecipe.com/meat_and_fish_dishes/beef_puchero.htm).

## Oven-Baked Potatoes

---

1. Cut potatoes in the shape of thick french fries.
2. Leave peel on. Arrange on a baking sheet that has been lightly sprayed with nonstick cooking spray.
3. Bake at 350 °F for 1 hour.



## Eggplant Omelet

---

1. Saute  $\frac{1}{2}$  cup chopped eggplant,  $\frac{1}{2}$  cup chopped onion, and 1 bay leaf in 2 teaspoons vegetable oil. Continue cooking until the vegetables are tender, and remove them from the heat. Remove and discard the bay leaf.
2. Whip 1 egg with  $\frac{1}{4}$  cup low-fat milk.
3. Grease an 8-inch skillet with 1 teaspoon vegetable oil. Pour whipped egg and milk into the greased and heated skillet, and cook so the egg batter resembles a pancake or omelet. Flip the omelet.
4. Pour the eggplant and onion on half of the omelet and fold over.
5. Slide the omelet onto a plate. Open the omelet, and season with black pepper. Refold before eating.

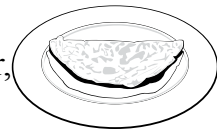

# Cooking With Less Saturated Fat *(continued)*

---

## ***Kamote* (Sweet Potato) Salad**

---

1. Dice boiled sweet potatoes to yield 2 cups.
2. To make the dressing, combine 1 tablespoon *kalamansi* juice,  $\frac{1}{3}$  cup low-fat mayonnaise, 1 tablespoon diced onion, 2 tablespoons diced celery, 1 tablespoon diced reduced-sodium pickle, 2 tablespoons diced red pepper, and  $\frac{1}{4}$  teaspoon salt.
3. Pour dressing over the 2 cups of diced sweet potatoes and mix.
4. Can be served warm or chilled.

Source: [http://www.filipinovegetarianrecipe.com/salads/sweet\\_potato\\_salad.htm](http://www.filipinovegetarianrecipe.com/salads/sweet_potato_salad.htm).

**Note:** The very sour *kalamansi* looks like a small, round lime and tastes like a cross between a lemon and a mandarin orange. It is very popular in the Philippines. You may substitute 3 parts lemon juice to 1 part mandarin orange juice, mixed together, for the *kalamansi*.

## **Fruit Shake**

---

1. Cut your favorite fruit into chunks.
2. Place in a blender, along with fat-free milk or plain, fat-free yogurt, vanilla extract, and ice.
3. Blend until smooth.



# Reduced-Fat *Adobong Manok* (Marinated Chicken) Recipe

This is a delicious low-cost recipe with low-sodium ingredients. Keep this recipe lower in fat by not adding meat fat (lard) or other fat.

- |                |                                 |   |
|----------------|---------------------------------|---|
| 1 pound (½ kg) | chicken breasts, no skin        | 1. Combine olive oil, garlic, and onion in a frying pan. Add chicken, and saute together until chicken has browned.   |
| 1 teaspoon     | olive oil                       | 2. Add light soy sauce, vinegar, paprika, black pepper, and bay leaves, and stir.   |
| 2 tablespoons  | light soy sauce                 | 3. Bring to a boil. Simmer for 45–60 minutes or until chicken is done.  |
| ¼ cup          | vinegar                         | 4. Remove the chicken, and save the liquid in the pot. Arrange the chicken on a broiler pan. Broil until the chicken has nicely browned. Remove from the broiler, and place it in a serving bowl. |
| 1 teaspoon     | paprika                         | 5. Continue to boil the sauce in the uncovered pan until volume is reduced to about half and the sauce is thick.  |
| 2              | cloves fresh garlic, crushed    | 6. Pour the thickened sauce over broiled <i>adobo</i> (chicken), and garnish with red tomatoes. Garnish <i>adobong</i> with red tomatoes, if desired.   |
| 2              | medium onions, chopped          |   |
| 2 tablespoons  | black pepper, ground            |   |
| 1              | bay leaf, broken in half        |   |
| 1              | medium red tomato<br>(optional) |   |

## Quick Facts

This recipe is lower in saturated fat and cholesterol because:

- The dish is made using chicken without the skin, and any extra fat is removed.
- Only 1 teaspoon of unsaturated fat (olive oil) is added.
- The dish is flavored with vegetables and herbs and is boiled and broiled slowly in moist heat instead of fat.

Yield:	Serving size
4 servings	½ cup:
Calories	190 kcal
Total Fat	5 g
Saturated Fat	1 g
Cholesterol	70 mg
Sodium	330 mg
Total Fiber	2 g
Protein	26 g
Carbohydrates	10 g
Potassium	370 mg

Source: Filipino-American Nutrition and Fitness Teachers Guide, Kalusugan Community Services, San Diego, CA.

# Lola's Life Lessons: Session 5

---

One of my favorite proverbs is:

*“Bilisan mo ang gawain. Hinay-hinay sa pagkain.”*

Translation: “If it is work, do it fast. If it is food, eat it little by little.”

To have food on the table is a blessing. Growing up in the province, my family and I never took this for granted. Food was always appreciated and respected. Today, there are too many food choices. When I first came here, I was overwhelmed, because seafood and cuts of meat were fresh and relatively cheap. So many snack foods and fast foods are available, too. These are expensive in the Philippines, but here, we can have them all the time.

How lucky I felt! I ate more foods that were high in fat and cholesterol. Mila and I were always making steak and fried *bangus* (milkfish). You feel wealthy living here and being able to afford these foods. It was only after Dr. Cabaya told me I had high blood pressure that I began to watch what I ate. It is hard, especially when you are trying to be a role model for the family.

But you need to have discipline. *Kung ang isa ay hindi makapag disisyon, saya ay walang kinabukasan.* (“One who cannot decide will have no future.”) Think about what you eat, how much you eat, and be consistent. Make changes for life, not just for the day, and not just for yourself, but for your family, too.

## A Time To Reflect...

What things keep you from eating foods lower in saturated fat, *trans* fat, and cholesterol? What changes can you make in your life to continue on your journey to heart health?

(Use this space to write down your thoughts for this week's session.)

# Pledge for Life! Session 5

---

Take the pledge for life with Lola Idad. Try to do at least one of these activities by yourself or with others.

- Choose low-fat and fat-free food products more often.
- Bake, steam, broil, or grill food instead of frying it.
- Cut off the fat from the meat before cooking it.
- Use less coconut milk and condensed milk to prepare food and drinks.
- Skim the fat off soups and stews before serving.
- Throw away—and do not reuse—the fat that is drained from fatty cuts of meat.
- Choose unsaturated fat and oils to prepare foods.
- Take the skin off chicken or *lechon*, and do not eat it.
- Include a variety of fruits, vegetables, and oatmeal as sources of soluble fiber.
- Exchange low-fat recipes with your friends and family.
- Other \_\_\_\_\_

# Keep the Beat: Aim for a Healthy Weight

---

## Objectives

**By the end of this session, group members will learn that:**

- Being overweight is a risk factor for high blood cholesterol, high blood pressure, diabetes, heart disease, and stroke.
  - Healthy weights are given in ranges.
  - Losing weight or keeping a healthy weight means making lifelong changes.
  - Fad diets usually do not work over the long term and can be harmful.
- 

## Materials and Supplies

**To conduct this session, you will need:**

- “Healthy Heart, Healthy Family” manual and picture cards
- Blackboard and chalk or several large pieces of paper, a marker, and tape
- Two bathroom scales
- A tape measure you can attach to the wall (to measure height)
- A cloth tape measure (to measure the waist)

- *(Optional)* Curling ribbon (to measure the waist)\*
- A Nutrition Facts label (from a can or package)
- 10 serving dishes or firm paper or plastic plates
- Four measuring cups
- Five spoons
- One knife
- Food
  - A 42-ounce box of dry oatmeal
  - A 15-ounce can of fruit or vegetables
  - A block of cheddar cheese (about ½ pound)
  - 3 cups of steamed rice
  - A 12- or 15-ounce can of corned beef hash

---

## **Handouts**

### **Give group members these handouts during this session:**

- “Body Mass Index (BMI) Chart” (pages 216–217)
- “Do You Need To Lose Weight?” (page 218)
- “Commit to Losing Weight: Make Long-Term Changes!” (page 219)
- “Lola’s Habits and Her Weight” (pages 220–221)
- “Lola’s Tips To Help You Control Your Weight” (page 222)
- *(Optional)* “A Visit From Back Home: Embracing a Balanced Lifestyle Role Play” (page 223)

---

\* If you choose to use ribbon instead of measuring tape, cut one ribbon at 35 inches for women and one ribbon at 40 inches for men.

- “Serving Sizes” (page 224)
- “Read the Nutrition Facts Label for Calories!” (page 225)
- “Lola’s Snack Choices” (pages 226–228)
- “*Lumpiang Sariwa* (Fresh *Lumpia*) Recipe” (pages 229–230)
- “Lola’s Life Lessons: Session 6” (page 231)
- “Pledge for Life! Session 6” (page 232)

---

## **Session Outline**

### **Introducing the Session**

1. Welcome
2. Review of Last Week’s Session
3. About This Session

### **Conducting the Session**

1. Facts About Overweight and Obesity
2. Your Weight and Your Health
3. What Is a Healthy Weight? Activity
4. The Healthy Way To Lose Weight
5. Beat Weight-Loss Barriers
6. *(Optional)* A Visit From Back Home: Embracing a Balanced Lifestyle Role Play
7. Serving Size Activity
8. Nutrition Facts Label Activity—Calories
9. *Lumpiang Sariwa* (Fresh *Lumpia*) Recipe



## Review of Today's Key Points

### Lola's Life Lessons: A Time To Reflect

### Pledge for Life!

### Closing

# Introducing the Session

---

## 1. Welcome

- Welcome group members to the session.

## 2. Review of Last Week's Session

### ■ Say:

Last week, we talked about why it is important to cut back on saturated fat, *trans* fat, and cholesterol. Can you tell me three things you can do to make food lower in fat?



**Note:** Add these possible answers if not mentioned by group members:

- Trim the fat from meat before cooking.
- Remove the skin from chicken and the fat from pork and fatty meats before cooking. Throw away the skin and fat.
- Bake, steam, broil, or grill food instead of frying it.

### ■ Ask:

At the end of the last session, you made a pledge to eat less saturated fat, *trans* fat, and cholesterol. What went well? Did you have any problems?



**Note:** Allow 5 minutes for group members to respond.

### 3. About This Session

■ **Say:**

Today, we will discuss why keeping a healthy weight is important to heart health.

■ **Say:**

When the session ends, you will know that:

- Being overweight increases your chances for high blood cholesterol, high blood pressure, diabetes, heart disease, and stroke.
- To lose weight:
  - Cut down on the calories you eat.
  - Eat smaller portions.
  - Be physically active.
- Fad diets usually do not work over the long term and can be harmful to you.

■ **Say:**

You will also find out if you need to lose weight by learning your body mass index (BMI) and your waist measure.

■ **Say:**

The de la Cruz family is trying to stay on track with healthy eating and being physically active. They have faced many challenges along the way, but Lola Idad always reminds them that “*Ang buhay ay parang gulong minsang nasa ibabaw, minsang nasa ilalim.*” This means, “Life is like a wheel; sometimes you are on top, sometimes you are on the bottom.” Lola believes that it is important to lead a balanced lifestyle if we want to meet our goals. In this session, Lola will share her story of working toward and maintaining a healthy weight.

# Conducting the Session

---

## 1. Facts About Overweight and Obesity

- Overweight and obesity increase the risk of heart disease and stroke. Losing 5 to 15 percent of body weight can make a difference.
- Among Asian adults (aged 18 and older) in the United States, about 25 percent are overweight. About 6 percent of those adults are obese.
- About 34 percent of the Filipino residents living in Hawaii are overweight, and 13 percent are obese.
- In the Philippines, about 24 percent of the adults (aged 20 years or older) are overweight or obese.

## 2. Your Weight and Your Health

■ **Say:**

Being overweight or obese increases your risk of heart disease and stroke. It also can contribute to the development of high blood cholesterol, high blood pressure, and diabetes. These can also cause heart disease.

■ **Say:**

Being overweight can increase the risk of developing some types of cancer. It can also make other health problems worse, such as arthritis and sleep disorders.

■ **Say:**

Losing a small amount of weight can improve many health problems that come from being overweight.

### 3. What Is a Healthy Weight? Activity



**Note:** Before beginning this activity, **place** the scales where group members can weigh themselves in private. **Write** the following information on the blackboard or on a large piece of paper taped to the wall.

Cesar weighs 175 pounds (79.5 kg). He is 5 feet, 6 inches (1.68 meters) tall.  
Mila weighs 125 pounds (56.7 kg). She is 5 feet (1.52 meters) tall.

- **Give** group members the “Body Mass Index (BMI) Chart” handout (pages 216–217).



- **Say:**

We are going to do an activity to find out if you have a healthy weight or if you should lose weight.

- **Show picture card 6.1.**

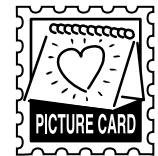

- **Say:**

First, we’re going to work together to find out if Cesar and Mila have healthy weights. We will use the Body Mass Index chart. The BMI chart lets us measure the weight of a person in relation to his or her height. The chart will help us find the BMI.

- **Say:**

Cesar weighs 175 pounds (79.5 kg), and he is 5 feet, 6 inches (1.68 meters) tall. His wife, Mila, weighs 125 pounds (56.7 kg), and she is 5 feet (1.5 meters) tall.

- **Say:**

Let’s use the BMI chart on the handout that I gave you to find out if Cesar and Mila have healthy weights.

■ **Say:**

Look for Cesar’s weight on the side of the chart, and circle it. Put your finger on the circled number, and lower your finger until you find the line that corresponds to Cesar’s height. The shade of the square will tell you if his weight is healthy or if he is overweight or obese.



**Note:** Allow 2 or 3 minutes for group members to look for the answer on the chart.

■ **Say:**

Now we will find Mila’s BMI, following the same steps.



**Note:** Allow 2 or 3 minutes for group members to look for the answer on the chart.

■ **Say:**

Cesar’s BMI is 28, so he is overweight. Mila’s BMI is 24, so she is at a healthy weight.

■ **Say:**

Now we are going to find out if you have a healthy weight. If you do not know how much you weigh, use the scale to weigh yourself. If you do not know your height, use the wall measure.



**Note:** Allow 15 minutes for group members to use the scales and wall measure.

- **Give** group members the “Do You Need To Lose Weight?” handout (page 218).



■ **Say:**

Now we’re going to take three simple steps to learn if we need to lose weight, and then we’re going to find out what actions we should take.

■ **Say:**

The first step is to find out our BMIs, using the chart on the handout that I gave you. We will follow the same process that we used with Cesar and Mila.

■ **Say:**

Find your weight at the top of the chart, and circle it. Put your finger on the circled number, and lower your finger until you find the line that corresponds to your height. The shade of the square will show you if your weight level is healthy, overweight, or obese. You do not have to share your BMI number with the group. Just check off your weight level on the handout.

■ **Say:**

Please raise your hand if you are having trouble, and I will help you.

■ **Say:**

The second step is to measure your waist.

■ **Show picture card 6.2.**

■ **Ask group members to measure their waists using the measuring tape.**

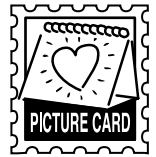

### Waist Measure

*(Optional) Note:* Some people may be sensitive about measuring their waists with a tape measure. To make this activity friendlier, you can use curling ribbon. Cut one ribbon at 35 inches (88 centimeters) for women and one ribbon at 40 inches (102 centimeters) for men, and give the ribbon to group members. Tell them how long the ribbon measures. If the ribbon does not go all the way around the group members' waists, their waist measures are high.

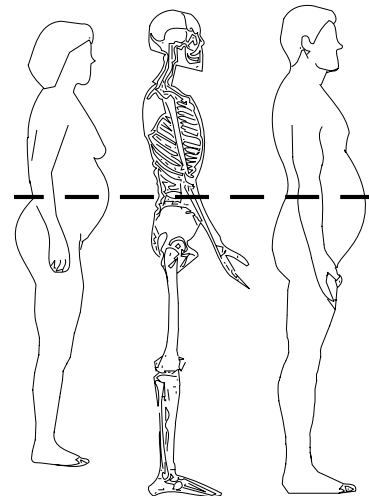

Measuring-Tape Position for Waist Measurement in Adults

■ **Say:**

Write down your waist measure, and check off the level of your waist measure: healthy or high. A waist measure greater than 35 inches (88 cm) for women and greater than 40 inches (102 cm) for men is high. **A high waist measure increases your risk for heart disease.**

■ **Say:**

In the third step, we will find out if you need to lose weight. Look at your BMI and waist measure.

■ **Say:**

If both are healthy, then you are at a healthy weight and do not need to lose weight. Good for you! Try not to gain weight.

■ **Copy** the text in the “Risk Factors” box onto the blackboard or a large piece of paper taped to the wall.

**Risk Factors**

- High blood pressure
- High LDL cholesterol (bad cholesterol)
- Low HDL cholesterol (good cholesterol)
- High triglycerides
- High blood glucose
- Family history of heart disease
- Not being physically active
- Smoking

■ **Say:**

Let’s review these risk factors.

■ **Ask:**

How many of these risk factors do you have?



**Note:** Allow a moment for group members to think about their answers to this question.

■ **Say:**

If your BMI is in the **overweight** range, and you have two or more of the risk factors we just listed, you should lose weight. It is important not to gain more weight. You should also lose weight if you are overweight with a high waist measure.

■ **Say:**

If your BMI is in the **obese** range, you also need to lose weight. It is important to lose weight slowly—about 1 to 2 pounds (0.45 to 0.91 kg) a week. Ask your doctor or a registered dietitian for help.



**Note:** Ask group members to look at the handout to see what actions they should take for their weight levels.

<b>Level</b>	<b>Action</b>
<b>Healthy Weight</b>	<ul style="list-style-type: none"><li>• Good for you! Try not to gain any weight.</li></ul>
<b>Overweight</b>	<ul style="list-style-type: none"><li>• It is important not to gain more weight.</li><li>• You need to lose weight if you are overweight and:<ul style="list-style-type: none"><li>— Have two or more risk factors, <b>or</b></li><li>— Have a high waist measurement.</li></ul></li><li>• Ask your doctor or a registered dietitian for help.</li></ul>
<b>Obese</b>	<ul style="list-style-type: none"><li>• You need to lose weight. Lose weight slowly—about 1 to 2 pounds (0.45 to 0.91 kg) a week.</li><li>• Ask your doctor or a registered dietitian for help.</li></ul>

## 4. The Healthy Way To Lose Weight

■ **Say:**

Let's talk about the healthy way to lose weight.

■ **Say:**

The measure of energy that the body gets from food is called a calorie. People gain weight when they eat more calories than their body uses for energy.



■ **Say:**

If you need to lose weight, you must choose foods with fewer calories or become more physically active. It is best to do both.

■ **Say:**

To lose weight, you must burn more calories than you eat.

■ **Say:**

Pregnant women should not try to lose weight.

- **Give** group members the “Commit to Losing Weight: Make Long-Term Changes!” handout (page 219) and “Lola’s Habits and Her Weight” handout (pages 220–221).



■ **Say:**

Please review the “Commit to Losing Weight: Make Long-Term Changes” handout to find out how Lola found success managing her weight.

■ **Say:**

The “Lola’s Heart Healthy Habits and Her Weight” handout is about how adding small amounts of daily activity can lead to weight loss over time.

- **Ask** for volunteers to read each scene aloud.

- **Show picture card 6.3.**

■ **Say:**

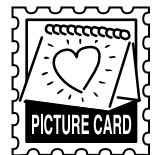

Like Lola in the third scene, you can lose weight in a healthy way: Eat smaller portions, eat a variety of foods lower in fat and calories, and increase your activity level.

■ **Say:**

Most people who lose weight and keep it off do so by losing the weight slowly. They learn to make lasting changes. They eat fewer calories and stay physically active. You should try to lose 1 to 2 pounds (0.45–0.91 kg) each week until you reach a healthy weight.

- Give group members the “Lola’s Tips To Help You Control Your Weight” handout (page 222). Review the tips for losing weight.



## 5. Beat Weight-Loss Barriers

- Ask:

Have any of you ever tried to lose weight?

- Ask people to share their experiences with the group. Ask them to tell what kept them motivated to lose weight.

- Ask:

Why do you think it is difficult for some people to lose weight or keep off the weight they lose?



**Note:** Write their answers on the blackboard or on a large piece of paper taped to the wall.

- Add some of the following answers if they are not mentioned.

Some people have a hard time losing weight because:

- They lack support from family members or friends.
- They attend many social gatherings and do not want to offend the host by not enjoying the food.
- They believe that healthy foods are too expensive.
- They believe that healthy foods and healthy versions of Filipino recipes do not taste good.
- Traditional Filipino foods are often high in fat and sodium.
- Some foods remind them of the Philippines, so they eat them even if they are high in fat, cholesterol, and sodium.
- Leaving leftovers is a waste. Eating everything on the plate is common.
- It is hard to limit portions of rice.

- They believe that being heavy means a person is healthy or rich.
- Fast food and takeout food are convenient and affordable.

■ **Ask:**

Have you found ways to beat these barriers to losing weight?



**Note:** Allow 3 to 5 minutes for group members to respond. **Write** their answers on the blackboard or on a large piece of paper taped to the wall.

■ **Add** some of the following answers if they are not mentioned:

- Find another person who also wants to lose weight. You can talk with this person to stay motivated.
- Walk or do other activities with another person. This makes it more fun, and the time will pass more quickly.
- Find activities that the whole family can enjoy so they can control their weight, too.
- Look for free or low-cost physical activity facilities at local community centers or parks and recreation programs.
- Share cooking chores and recipes with friends. For example, if family members will not eat lower-calorie dishes, make a dish and share it with a friend. Your friend can make a dish and share it with you.

■ **Say:**

Ask your doctor or a registered dietitian to help you develop a plan if you have a lot of weight to lose. Tell your doctor if you are taking any traditional medicines to help you lose weight.

■ **Show picture card 6.4.**

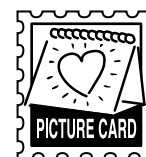

■ **Say:**

Losing weight has become a moneymaking business. You hear about miracle diets that claim to help you lose weight quickly and easily. These products make only one thing lighter—and that's your wallet. Be careful about ads that promote diets and exercise products using personal testimonies.

■ **Say:**

Diets that promise quick weight loss rarely work. Many of these diets include only a few foods. People get bored with them quickly. These diets do not provide all the nutrients and energy your body needs. They are not healthy.

## 6. (Optional) A Visit From Back Home: Embracing a Balanced Lifestyle Role Play

- Give group members the “A Visit From Back Home: Embracing a Balanced Lifestyle Role Play” handout (page 223).



- Ask three volunteers to be actors for the role play. As the trainer, you can **read** the introduction.



**Note:** After the activity is completed, allow 5 minutes for discussion by asking the following questions.

■ **Ask:**

- What are some of the lessons we learned from this role play?
- Is there any part of the play that you can use in your own life?

## 7. Serving Size Activity

■ **Say:**

Let’s look at how big a serving is. In Session 8, “Welcome Heart Healthy Eating Into Your Home,” we will look at how much you should eat.



## Before the session

1. Check the “Serving Sizes” handout (page 224) for the serving size of each food. Measure one serving of each food, and put each in a separate dish or other container.
2. Place the dishes with these premeasured foods out of sight.
3. Place the box of dry oatmeal, a large bowl of steamed rice, a can of fruit or vegetables, a block of cheddar cheese, and a can of corned beef hash on a table with five dishes, four serving spoons, and a knife.

■ **Ask** five volunteers to come to the table. **Ask** each volunteer to do one of the following:

1. Spoon out a serving of dry oatmeal, and put it on a dish.
2. Spoon out a serving of steamed rice, and put it on a dish.
3. Cut a serving of cheese, and put it on a dish.
4. Spoon out a serving of the fruit or vegetable, and put it on a dish.
5. Spoon out a serving of corned beef hash, and put it on a dish.

■ **Bring** out the foods you measured before the session. **Compare** the volunteers’ serving sizes with the true amounts.

■ **Give** group members the “Serving Sizes” handout (page 224). **Ask** volunteers to read aloud the serving sizes for each. **Tell** them to use this handout at home.

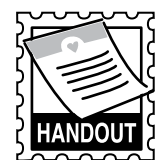

## 8. Nutrition Facts Label Activity—Calories



**Note:** This activity will help group members choose foods that are lower in calories.

■ **Say:**

We have learned that to lose weight, a person must eat fewer calories than the body burns for energy. In the last session, you learned how to use the Nutrition Facts label to choose foods that are lower in saturated fat, *trans* fat, and cholesterol. Today, we are going to learn how to use the Nutrition Facts label to choose foods that are lower in calories.

■ **Show picture card 6.5.**

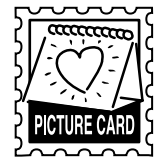

■ **Say:**

Here's where you can look to find the number of calories in one serving on the Nutrition Facts label. This Nutrition Facts label shows the number of calories in canned fruit cocktail in heavy syrup at the bottom of the handout.

■ **Give** group members the “Read the Nutrition Facts Label for Calories!” handout (page 225).



■ **Say:**

Look at the Nutrition Facts labels for canned fruit cocktail in fruit juice and canned fruit cocktail in heavy syrup at the bottom of the handout. Which fruit cocktail has fewer calories?



**Note:** Allow 1 to 2 minutes for group members to respond.

■ **Say:**

Fruit cocktail in fruit juice has fewer calories. There are 60 calories in one serving, or  $\frac{1}{2}$  cup, of the fruit cocktail in fruit juice. There are 100 calories in one serving of the fruit cocktail in heavy syrup—almost twice as many calories as the fruit cocktail in fruit juice.

■ **Say:**

“Fat free” does not mean free of calories. You need to watch the calories and fat when comparing Nutrition Facts labels.

Here are a few examples:

Calories in reduced-fat food	Calories in regular-fat food
Reduced-fat chocolate chip cookies, 118 3 cookies (30 grams) calories	Regular chocolate chip cookies, 142 3 cookies (30 grams) calories
Fat-free potato chips, 107 1 ounce calories	Salt-and-vinegar potato chips, 151 1 ounce calories

■ **Say:**

Let’s try another group activity. I will tell you about a common problem for families today. Then we will learn how to use Nutrition Facts labels to help solve the problem.

- **Give** group members the “Lola’s Snack Choices” handout (pages 226–228). **Read** “Lola’s Family Eats Healthier Snacks” (page 211). **Ask** group members which foods Lola should serve.

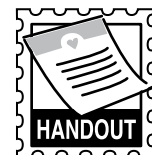

## Lola's Family Eats Healthier Snacks

Lola and her family like to have snacks when they watch television. Recently, Lola and Mila have noticed that their visiting family has gained too much weight. Use the Nutrition Facts labels to help choose some tasty snacks that are lower in calories. What should Lola serve? Write the number of your choice for each pair on the line. Then write the number of calories saved by this choice.



**Note:** The choices that are lower in calories are underlined below. The number of calories saved by making the right choice is given below each choice.

Shrimp-flavored crackers (1¼ cups) or air-popped popcorn (1 cup)?  
Choosing popcorn saves 129 calories.

Pineapple (½ cup) or a slice of *bibingka*?  
Choosing the pineapple saves more than 800 calories.

One cup of whole milk or one cup of fat-free (skim) milk?  
Choosing the fat-free (skim) milk saves 60 calories.

Ice cream (½ cup) or one popsicle?  
Choosing the popsicle saves 125 calories.

Canned fruit cocktail in fruit juice (½ cup) or canned fruit cocktail in heavy syrup (½ cup)?  
Choosing the fruit cocktail in fruit juice saves 40 calories.

Banana chips (1 ounce) or dried prunes (5 prunes)?  
Choosing the dried prunes saves 50 calories.

### ■ Ask:

- What is an example of a higher-calorie snack that your family eats?
- What is an example of a lower-calorie snack that your family would enjoy?



**Note:** Allow a few minutes for group members to respond.



## 9. *Lumpiang Sariwa* (Fresh Lumpia) Recipe



- Give group members the “*Lumpiang Sariwa* (Fresh Lumpia) Recipe” handout (pages 229–230).
- Say:

This is easy to make. It has only 112 calories and about 4 grams of fat per serving. It is also low in sodium. Try the recipe at home this week!

## Review of Today’s Key Points

---

- Say:

Let’s review what we learned today.

### **Why is it important to maintain a healthy weight?**

- Being overweight may increase your risk of heart disease, high blood pressure, high blood cholesterol, diabetes, and some types of cancer.

### **What is the healthiest way to lose weight?**

- Eat smaller portions of a variety of foods lower in fat and calories, and increase your physical activity.

### **How can the Nutrition Facts label help you if you need to lose weight?**

- The Nutrition Facts label tells you the serving size and the number of calories per serving. You can compare calories on different packages to choose foods that are lower in calories.

# Lola's Life Lessons: A Time To Reflect

## ■ Say:

In the last session, Lola Idad reminded us that the steps to a healthy heart require discipline, which means taking control of your eating habits. This week, Lola encourages us to maintain a healthy weight. If you are overweight or obese, you can work toward a healthy weight by eating healthy, increasing physical activity, and losing weight slowly.

- Give each group member the “Lola’s Life Lessons: Session 6” handout (page 231). Ask a volunteer to read the handout.



## ■ Say:

Please take a few moments to reflect on Lola’s advice and how this applies to your life. At the bottom of the handout, there is a space called “A Time To Reflect.” Use this section to record your thoughts and feelings about this week’s session. Remember, this is for you and no one else.

- Give each group member 2 to 3 minutes to write down some thoughts.

## Pledge for Life!

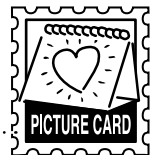

## ■ Say:

You have learned a lot today about losing weight the healthy way. Now, let’s think about how you can apply what you have learned. Please think of one change you can make in your everyday life to reach or keep a healthy weight.

■ **Say:**

Be specific about **what** you plan to do, **how** you plan to do it, and **when** you will start. Here are some examples:

- I will buy vegetable oil spray when I go to the grocery store next week. I will use it instead of butter when I cook breakfast.
- I will walk for 30 minutes on most days during my lunch break at work, starting tomorrow.
- I will eat only half of my entree the next time I eat out to cut down on my food portion. I will take the other half home and save it for another meal.

- **Give** each group member the “Pledge for Life! Session 6” handout (page 232).



■ **Say:**

Take the pledge for life with Lola and her family. Take a step toward staying heart healthy and maintaining or reaching a healthy weight. Pledge to do one thing on this list during the coming week. Now, let’s start by sharing our goals with each other.



**Note:** Tell group members to be very specific about what they plan to do. (For example, if they say they will eat fewer calories, ask them to name some ways they can do this.) Give each group member 2 to 3 minutes to share.

■ **Say:**

We will discuss the results of your pledges next week. Don’t forget to continue working on your pledges to be more physically active and to cut back on salt, sodium, saturated fat, *trans* fat, and cholesterol.

# Closing

---

■ **Say:**

Thank you for coming today. What did you think of today's session?



**Note:** Allow a moment for group members to respond.

■ **Say:**

I am looking forward to seeing you at the next session. The next session will be about diabetes and how it relates to heart disease.



**Note for Educator:** Think about today's session. What worked and didn't work? Have you made any changes in your own life to know and control the risk factors for heart disease that were covered in today's session?

# Body Mass Index (BMI) Chart

Weight in Pounds (lbs)/Kilograms (kg)

	100 lbs 45 kg	110 lbs 50 kg	120 lbs 54 kg	130 lbs 59 kg	140 lbs 63 kg	150 lbs 68 kg	160 lbs 73 kg	170 lbs 77 kg	180 lbs 82 kg	190 lbs 86 kg	200 lbs 91 kg	210 lbs 95 kg	220 lbs 100 kg	230 lbs 104 kg	240 lbs 109 kg	250 lbs 113 kg
4'8" 1.46 m	22	25	26	29	31	34	36	38	40	43	45	47	49	52	54	56
4'9" 1.49 m	22	24	26	28	30	33	35	37	39	41	43	45	48	50	52	54
4'10" 1.47 m	21	23	25	27	29	31	34	36	38	40	42	44	46	48	50	52
4'11" 1.50 m	20	22	24	26	28	30	32	34	36	38	40	42	44	46	49	51
5'0" 1.52 m	20	22	23	25	27	29	31	33	35	37	39	41	43	45	47	49
5'1" 1.55 m	19	21	23	25	26	28	30	32	34	36	38	40	42	44	45	47
5'2" 1.57 m		20	22	24	26	27	29	31	33	35	37	38	40	42	44	46
5'3" 1.60 m		20	21	23	25	27	28	30	32	34	35	37	39	41	43	44
5'4" 1.63 m		19	21	22	24	26	28	29	31	33	34	36	38	40	41	43
5'5" 1.65 m			20	22	23	25	27	28	30	32	33	35	37	38	40	42
5'6" 1.68 m			19	21	23	24	26	27	29	31	32	34	36	37	39	40
5'7" 1.70 m			19	20	22	24	25	27	28	30	31	33	35	36	38	39
5'8" 1.73 m				20	21	23	24	26	27	29	30	32	34	35	37	38
5'9" 1.75 m				19	21	22	24	25	27	28	30	31	33	34	35	37
5'10" 1.78 m				19	20	22	23	24	26	27	29	30	32	33	35	36
5'11" 1.80 m					20	21	22	24	25	27	28	29	31	32	34	35
6'0" 1.83 m					19	20	22	23	24	26	27	28	30	31	33	34
6'1" 1.85 m					19	20	21	22	24	25	26	28	29	30	32	33

Healthy Weight

Overweight

Obese

Height in Feet and Inches/Meters (m)

# Body Mass Index (BMI) Chart

Timbang sa Libras (lbs) at Kilo (kg)

	100 lbs 45 kg	110 lbs 50 kg	120 lbs 54 kg	130 lbs 59 kg	140 lbs 63 kg	150 lbs 68 kg	160 lbs 73 kg	170 lbs 77 kg	180 lbs 82 kg	190 lbs 86 kg	200 lbs 91 kg	210 lbs 95 kg	220 lbs 100 kg	230 lbs 104 kg	240 lbs 109 kg	250 lbs 113 kg
4'8" 1.46 m	22	25	26	29	31	34	36	38	40	43	45	47	49	52	54	56
4'9" 1.49 m	22	24	26	28	30	33	35	37	39	41	43	45	48	50	52	54
4'10" 1.47 m	21	23	25	27	29	31	34	36	38	40	42	44	46	48	50	52
4'11" 1.50 m	20	22	24	26	28	30	32	34	36	38	40	42	44	46	49	51
5'0" 1.52 m	20	22	23	25	27	29	31	33	35	37	39	41	43	45	47	49
5'1" 1.55 m	19	21	23	25	26	28	30	32	34	36	38	40	42	44	45	47
5'2" 1.57 m		20	22	24	26	27	29	31	33	35	37	38	40	42	44	46
5'3" 1.60 m		20	21	23	25	27	28	30	32	34	35	37	39	41	43	44
5'4" 1.63 m		19	21	22	24	26	28	29	31	33	34	36	38	40	41	43
5'5" 1.65 m			20	22	23	25	27	28	30	32	33	35	37	38	40	42
5'6" 1.68 m			19	21	23	24	26	27	29	31	32	34	36	37	39	40
5'7" 1.70 m			19	20	22	24	25	27	28	30	31	33	35	36	38	39
5'8" 1.73 m				20	21	23	24	26	27	29	30	32	34	35	37	38
5'9" 1.75 m				19	21	22	24	25	27	28	30	31	33	34	35	37
5'10" 1.78 m				19	20	22	23	24	26	27	29	30	32	33	35	36
5'11" 1.80 m					20	21	22	24	25	27	28	29	31	32	34	35
6'0" 1.83 m					19	20	22	23	24	26	27	28	30	31	34	35
6'1" 1.85 m					19	20	21	22	24	26	27	28	30	31	33	34
					19	20	21	22	24	25	26	28	29	30	32	33

■ Obese

■ Labis sa Timbang

■ Malusog na Timbang

Tangkad sa Piye at Pulgada at Metro (m)

# Do You Need To Lose Weight?

Let's follow these steps to find out if you need to lose weight.

## 1. Learn if your weight is healthy.

Weigh yourself. Use the BMI chart to find out whether your weight is in the healthy range for people your height. Find your weight on the top of the chart and circle it. Put your finger on the circled number, and lower your finger until you find the line that corresponds to your height. The shade of your square will show if your weight level is healthy, overweight, or obese.

My weight is:

- Healthy  
 Overweight  
 Obese



## 2. Measure your waist.

Measure your waist by placing the measuring tape snugly around your waist. A high waist measure increases your risk for heart disease.

Write down your waist measurement: \_\_\_\_\_



Your waist measurement is high if:

- Women—Your waist measure is greater than 35 inches (88 cm).
- Men—Your waist measure is greater than 40 inches (102 cm).

My waist measurement is:

- Healthy     High

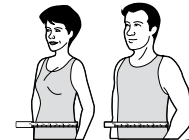

## 3. Find out if you need to lose weight.



Check off your weight level below to find out if you need to lose weight.

**Level**

**Action**

**Healthy Weight**

- Good for you! Try not to gain any weight.

**Overweight**

- It is important not to gain more weight.
- You need to lose weight if you are overweight **and**:
  - You have two or more heart disease risk factors, **or**
  - You have a high waist measurement.
- Ask your doctor or a registered dietitian for help.

**Obese**

- You need to lose weight. Lose weight slowly—about 1 to 2 pounds (0.45–0.91 kg) a week. Ask your doctor or a registered dietitian for help.



# Commit to Losing Weight: Make Long-Term Changes!

Here is how  
Lola Idad  
found success.

I used to weigh 150 pounds (68 kg). I was able to lose weight by eating smaller portions of the foods I like and walking regularly. I also eat fewer fatty foods and sweets and more fruits and vegetables. After I lost 20 pounds (9.1 kg), my blood pressure went down. Now I stay at a healthy weight while still enjoying what I eat and walking on most days.



## Try these tips to get started.

- ♥ Eat fewer foods that are high in saturated fat—such as fried foods, pork rinds, canned meats, and sausage.
- ♥ Cut down on cakes, pastries, candy, and soft drinks.
- ♥ Eat more fruits, vegetables, and whole grains. 
- ♥ Make stews with lean meat or skinless poultry and vegetables.
- ♥ Serve small portions, and eat salad if you are still hungry. Do not skip meals. 
- ♥ Aim for 60 minutes of physical activity each day.

**Make your personal pledge to do what the de la Cruz family is doing! Look at these examples:**

### When shopping

Read labels to choose foods lower in calories.

### When cooking

Bake, steam, broil, or grill fish instead of frying it. Use vegetable oil spray instead of greasing the pan with oil or shortening. 

### When eating

Have green beans and steamed rice with one piece of chicken instead of three pieces of chicken alone.

### Get active

If pressed for time, walk for 20 minutes three times a day: before work, during lunch, and with the family after dinner. 

**Your health and that of your family is priceless. Value it!**



# Lola's Habits and Her Weight



Eat big portions.



Not being physically active.

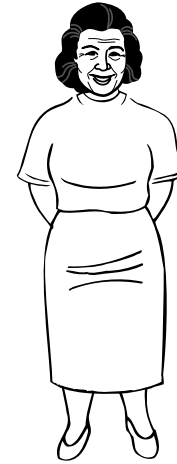

Gain weight.



Eat moderate portions.



Be physically active most days.



Maintain weight.



Eat small portions.



Be physically active most days.



Lose weight.

# Mga Kinagawian ni Lola at Kanyang Timbang



Kumain ng mga malalaking takal.



Hindi pagiging aktibong pisikal.



Madadagdagan ang timbang.



Kumain ng mga katamtaman na laki na takal.



Pagiging aktibong pisikal sa nakararaming mga araw.



Mananatili ang timbang.



Kumain ng mga maliliit na takal.



Pagiging aktibong pisikal sa nakararaming mga araw.



Mababawasan ang timbang.

# Lola's Tips To Help You Control Your Weight

## 1. Choose foods low in fat and low in calories. Try:

- ♥ Fat-free milk or low-fat (1%) milk instead of whole milk or coconut milk
- ♥ Cheeses marked “fat free” or “low fat” on the package
- ♥ Canned food labeled “light” or “lite”—Read the Nutrition Facts label!
- ♥ Fruits and vegetables without butter or sauce—Fruits and vegetables are low in calories and help you feel fuller.
- ♥ Steamed rice, cereals, and whole-grain noodles (pasta)
- ♥ Lean cuts of meat, seafood, and skinless chicken
- ♥ Water or low-calorie drinks instead of soft drinks and sugar-filled fruit drinks



## 2. Make foods the healthy way.

- ♥ Bake, steam, broil, or grill instead of frying foods.
- ♥ Prepare rice without lard or fatty meats.
- ♥ Use less high-fat cheese, lard, coconut oil, and butter when cooking.
- ♥ Use vegetable oil spray or a little bit of vegetable oil or tub margarine when cooking.
- ♥ Flavor salads with fat-free or low-fat mayonnaise or salad dressing.
- ♥ Marinate meats, poultry, and fish in a mixture of juice, garlic, onions, and herbs.



## 3. Limit your portion size.

- ♥ Serve smaller portions, and do not have second helpings. Have a salad if you are still hungry.
- ♥ Eat smaller meals and snacks throughout the day instead of having one big meal.
- ♥ When eating out, watch your portion sizes. Many restaurants now serve food portions that are too big. Share an entree, or bring half home.
- ♥ Go to buffets less often. Order from the menu.
- ♥ If you drink fruit juice, make sure it is 100 percent fruit juice. Keep an eye on the portion size. The calories in beverages add up quickly.

## 4. Get active! Say goodbye to excuses!

- ♥ Do your favorite physical activity for at least 60 minutes each day.  
**Try this:** If you are pressed for time, walk for 20 minutes three times a day.

## 5. Aim for a healthy weight.

- ♥ Try not to gain extra weight. If you are overweight, try to lose weight slowly. Lose about 1 to 2 pounds (0.45–0.91 kg) a week. Losing even 10 pounds (4.5 kg) can help reduce your chances of developing heart disease.



# A Visit From Back Home: Embracing a Balanced Lifestyle Role Play

---

Leticia (“Letty”), Lola’s youngest daughter, is visiting the United States from the Philippines. During her 2-week visit, Leticia begins learning tips for heart healthy living from her mother and family. Lola, Leticia, and Victoria (Lola’s friend and walking partner) are taking their daily morning walk in the park.

**Victoria:** Letty, it is good you are walking with us! You look like you have gained some weight, and you need to get moving!

**Leticia:** No, *Tita*,\* I am just really healthy! Actually, I want to lose some weight, but I do not have the time to cook healthy or to work out. I am really busy at work these days.

**Lola:** *Anak*,† even when I went back home last year, you were a lot slimmer. You tend to eat a lot when you are under stress. You have to be careful since our family has a history of heart disease and overweight. Even your brothers did not begin taking care of themselves until after they got sick. Look at your Mama. If I can lose weight, then you can, too.

**Leticia:** You do look healthy, Mama. I just had a checkup, and my BMI and waist measurement are high. The nurse said that my high BMI and the extra inches around my waist put me at higher risk for heart disease.

**Lola:** Just remember that a balanced lifestyle is important. Why would you pay more attention to your work than to your health?

**Leticia:** You are right, Mama.

**Lola:** You are still young, *anak*! You should have a lot of energy.









**Leticia:** Okay, okay! I will start by joining your daily walks and learn some new recipes while I am here. One step at a time, right?

**Victoria:** Do not worry, *Idad*! I know she will make us proud.

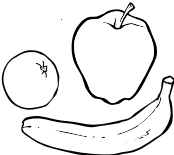
\**Tita* means “auntie” in Tagalog.

†*Anak* means “child” in Tagalog.

# Serving Sizes

Food Group	Serving Sizes
Grains*	 1 slice bread 1 ounce dry cereal† ½ cup steamed rice, cooked pasta, or cereal
Vegetables	 1 cup raw leafy vegetable ½ cup raw or cooked vegetable, cut up ½ cup vegetable juice
Fruits	 1 medium piece of fruit ¼ cup dried fruit ½ cup fresh, frozen, or canned fruit ½ cup fruit juice
Fat-free or low-fat milk and milk products	 1 cup fat-free or low-fat milk or yogurt ‡ 1½ ounces cheese
Lean meats, poultry, and fish	 1 ounce cooked (not fried) meat, poultry without the skin, or fish 1 egg§
Nuts, seeds, and legumes	 ⅓ cup or 1½ ounces nuts 2 tablespoons peanut butter 2 tablespoons or ½ ounce seeds ½ cup cooked legumes (dry beans and peas)
Fats and oils	 1 teaspoon tub margarine 1 teaspoon vegetable oil 1 tablespoon low-fat or fat-free mayonnaise 2 tablespoons low-fat or fat-free salad dressing
Sweets and added sugars	 1 tablespoon sugar 1 tablespoon jelly or jam ½ cup sorbet, gelatin 1 cup lemonade

\* Whole grains are recommended for most grain servings as a good source of fiber and nutrients..

† Serving sizes vary between ½ cup and 1⅓ cups, depending on cereal type. Check the product's Nutrition Facts label.

‡ There are lactose-free alternatives available for people who are lactose intolerant.

§ Limit the number of egg yolks to four per week.

# Read the Nutrition Facts Label for Calories!



Nutrition Facts labels tell you what you need to know about choosing foods that are lower in calories. Here is a Nutrition Facts label for a can of fruit cocktail in fruit juice.

## Canned Fruit Cocktail (in fruit juice)

Nutrition Facts	
Serving Size ½ cup (110g)	
Servings Per Container 3.5	
Amount Per Serving	
<b>Calories</b> 60	Calories from Fat 0
% Daily Value*	
<b>Total Fat</b> 0g	<b>0%</b>
Saturated Fat 0g	0%
Trans Fat 0g	
<b>Cholesterol</b> 0mg	<b>0%</b>
<b>Sodium</b> 10mg	<b>0%</b>
<b>Total Carbohydrate</b> 15g	<b>5%</b>
Dietary Fiber 1g	4%
Sugars 14g	
<b>Protein</b> 0g	
Vitamin A 4%	Vitamin C 4%
Calcium 0%	Iron 2%

### Amount Per Serving

The nutrient amounts are for one serving. So, if you eat more than one serving, you need to add nutrient amounts. For example, if you eat 1 cup of fruit cocktail, you are eating two servings. You would need to double the amount of calories on the label.

### Serving Size and Number of Servings

The serving size is ½ cup. There are 3½ servings in the can.

### Calories

The amount of calories in one serving is given here.

### Sugar

The amount of sugar is shown here.

## The Choice Is Yours—Compare!

### Which one would you choose?

Canned fruits packed in syrup have added calories. Read the Nutrition Facts label to choose fruits packed in fruit juice for a lower-calorie snack or dessert.

<b>Calories</b> 60	Calories from Fat 0
% Daily Value*	
<b>Total Fat</b> 0g	<b>0%</b>
Saturated Fat 0g	0%
Trans Fat 0g	
<b>Cholesterol</b> 0mg	<b>0%</b>
<b>Sodium</b> 10mg	<b>0%</b>

### Canned Fruit Cocktail (in Fruit Juice)

Canned fruit cocktail in fruit juice has 60 calories in a ½-cup serving.

<b>Calories</b> 100	Calories from Fat 0
% Daily Value*	
<b>Total Fat</b> 0g	<b>0%</b>
Saturated Fat 0g	0%
Trans Fat 0g	
<b>Cholesterol</b> 0mg	<b>0%</b>
<b>Sodium</b> 10mg	<b>0%</b>

### Canned Fruit Cocktail (in Heavy Syrup)

Canned fruit cocktail in syrup has 100 calories in a ½-cup serving—almost twice the calories found in a ½-cup serving of canned fruit cocktail in fruit juice. This is an important difference when trying to lose weight or maintain a healthy weight.

\* **Percent Daily Values** are based on a 2,000-calorie diet. Your Daily Values may be higher or lower depending on your calorie needs.

# Lola's Snack Choices



Lola and her family like to have snacks when they watch television. Recently, she and Mila have noticed that the family has gained too much weight.

Use the Nutrition Facts labels to choose some tasty snacks that are lower in calories. What should the family eat?

Write the number of your choice for each pair in the space between the labels. Then write the number of calories saved by this choice.

## 1 – Shrimp-flavored Crackers

Nutrition Facts	
Serving Size 1¼ cup (30g)	
Servings Per Container 2.5	
Amount Per Serving	
<b>Calories</b> 160	Calories from Fat 60
% Daily Value*	
<b>Total Fat</b> 7g	<b>11%</b>
Saturated Fat 3g	<b>15%</b>
<i>Trans</i> Fat 0g	
<b>Cholesterol</b> 0mg	<b>0%</b>
<b>Sodium</b> 260mg	<b>11%</b>
<b>Total Carbohydrate</b> 21g	<b>7%</b>
Dietary Fiber 1g	<b>4%</b>
Sugars 1g	
<b>Protein</b> 2g	
Vitamin A 0% • Vitamin C 0%	
Calcium 2% • Iron 0%	

Lower  
calorie  
choice

Number  
of calories  
saved

## 2 – Popcorn (Air Popped)

Nutrition Facts	
Serving Size 1 cup (8g)	
Servings Per Container 4	
Amount Per Serving	
<b>Calories</b> 30	Calories from Fat 0
% Daily Value*	
<b>Total Fat</b> 0g	<b>0%</b>
Saturated Fat 0g	<b>0%</b>
<i>Trans</i> Fat 1g	
<b>Cholesterol</b> 0mg	<b>0%</b>
<b>Sodium</b> 0mg	<b>0%</b>
<b>Total Carbohydrate</b> 7g	<b>2%</b>
Dietary Fiber 1g	<b>4%</b>
Sugars 0g	
<b>Protein</b> 1g	
Vitamin A 0% • Vitamin C 0%	
Calcium 0% • Iron 0%	

## 3 – Apple

Nutrition Facts	
Serving Size 1 medium (154g)	
Servings Per Container 1	
Amount Per Serving	
<b>Calories</b> 80	Calories from Fat 5
% Daily Value*	
<b>Total Fat</b> 0g	<b>1%</b>
Saturated Fat 0g	<b>0%</b>
<i>Trans</i> Fat 0g	
<b>Cholesterol</b> 0mg	<b>0%</b>
<b>Sodium</b> 920mg	<b>0%</b>
<b>Total Carbohydrate</b> 0g	<b>8%</b>
Dietary Fiber 0g	<b>16%</b>
Sugars 20g	
<b>Protein</b> 0g	
Vitamin A 0% • Vitamin C 6%	
Calcium 0% • Iron 0%	

Lower  
calorie  
choice

Number  
of calories  
saved

## 4 – Bibingka (Sweet Rice Cake)

Nutrition Facts	
Serving Size 1 slice (273g)	
Servings Per Container 4	
Amount Per Serving	
<b>Calories</b> 890	Calories from Fat 460
% Daily Value*	
<b>Total Fat</b> 51g	<b>78%</b>
Saturated Fat 37g	<b>185%</b>
<i>Trans</i> Fat 0g	
<b>Cholesterol</b> 219mg	<b>73%</b>
<b>Sodium</b> 1940mg	<b>81%</b>
<b>Total Carbohydrate</b> 99g	<b>33%</b>
Dietary Fiber 6g	<b>24%</b>
Sugars 44g	
<b>Protein</b> 15g	
Vitamin A 17% • Vitamin C 3%	
Calcium 105% • Iron 21%	

\* Percent Daily Values are based on a 2,000-calorie diet. Your Daily Values may be higher or lower depending on your calorie needs.

# Lola's Snack Choices *(continued)*

## 5 – Whole Milk

<b>Nutrition Facts</b>	
Serving Size 236mL (1 cup)	
Servings Per Container 16	
Amount Per Serving	
<b>Calories</b> 150	Calories from Fat 70
% Daily Value*	
<b>Total Fat</b> 8g	<b>12%</b>
Saturated Fat 5g	<b>25%</b>
Trans Fat 0g	
<b>Cholesterol</b> 35mg	<b>12%</b>
<b>Sodium</b> 125mg	<b>5%</b>
<b>Total Carbohydrate</b> 12g	<b>4%</b>
Dietary Fiber 0g	<b>0%</b>
Sugars 11g	
<b>Protein</b> 8g	
Vitamin A 6%	Vitamin C 4%
Calcium 30%	Iron 0% • Vitamin D 25%

Lower  
calorie  
choice

Number  
of calories  
saved

## 6 – Fat-Free Milk

<b>Nutrition Facts</b>	
Serving Size 236mL (1 cup)	
Servings Per Container 16	
Amount Per Serving	
<b>Calories</b> 90	Calories from Fat 0
% Daily Value*	
<b>Total Fat</b> 0g	<b>0%</b>
Saturated Fat 0g	<b>0%</b>
Trans Fat 0g	
<b>Cholesterol</b> 5mg	<b>2%</b>
<b>Sodium</b> 125mg	<b>5%</b>
<b>Total Carbohydrate</b> 12g	<b>4%</b>
Dietary Fiber 0g	<b>0%</b>
Sugars 11g	
<b>Protein</b> 8g	
Vitamin A 10%	Vitamin C 4%
Calcium 30%	Iron 0% • Vitamin D 25%

## 7 – Chocolate Ice Cream

<b>Nutrition Facts</b>	
Serving Size ½ cup (66g)	
Servings Per Container 16	
Amount Per Serving	
<b>Calories</b> 170	Calories from Fat 80
% Daily Value*	
<b>Total Fat</b> 9g	<b>14%</b>
Saturated Fat 6g	<b>30%</b>
Trans Fat 0g	
<b>Cholesterol</b> 20mg	<b>7%</b>
<b>Sodium</b> 40mg	<b>2%</b>
<b>Total Carbohydrate</b> 21g	<b>7%</b>
Dietary Fiber 1g	<b>4%</b>
Sugars 17g	
<b>Protein</b> 2g	
Vitamin A 4%	Vitamin C 0%
Calcium 6%	Iron 4%

Lower  
calorie  
choice

Number  
of calories  
saved

## 8 – Popsicle

<b>Nutrition Facts</b>	
Serving Size 1 popsicle (88g)	
Servings Per Container 12	
Amount Per Serving	
<b>Calories</b> 45	Calories from Fat 80
% Daily Value*	
<b>Total Fat</b> 0g	<b>0%</b>
Saturated Fat 0g	<b>0%</b>
Trans Fat 0g	
<b>Cholesterol</b> 0mg	<b>0%</b>
<b>Sodium</b> 40mg	<b>2%</b>
<b>Total Carbohydrate</b> 11g	<b>4%</b>
Dietary Fiber 0g	<b>0%</b>
Sugars 11g	
<b>Protein</b> 0g	
Vitamin A 0%	Vitamin C 0%
Calcium 0%	Iron 0%

\* **Percent Daily Values** are based on a 2,000-calorie diet. Your Daily Values may be higher or lower depending on your calorie needs.



# Lola's Snack Choices *(continued)*

## 9 – Canned Peaches (in Fruit Juice)

<b>Nutrition Facts</b>	
Serving Size ½ cup (110g)	
Servings Per Container 4	
Amount Per Serving	
<b>Calories</b> 50	Calories from Fat 0
% Daily Value*	
<b>Total Fat</b> 0g	<b>0%</b>
Saturated Fat 0g	<b>0%</b>
<i>Trans</i> Fat 0g	
<b>Cholesterol</b> 0mg	<b>0%</b>
<b>Sodium</b> 25mg	<b>1%</b>
<b>Total Carbohydrate</b> 13g	<b>4%</b>
Dietary Fiber 1g	<b>4%</b>
Sugars 9g	
<b>Protein</b> 0g	
Vitamin A 8%	• Vitamin C 2%
Calcium 0%	• Iron 0%

Lower  
calorie  
choice

Number  
of calories  
saved

## 10 – Canned Peaches (in Heavy Syrup)

<b>Nutrition Facts</b>	
Serving Size ½ cup (110g)	
Servings Per Container 4	
Amount Per Serving	
<b>Calories</b> 100	Calories from Fat 0
% Daily Value*	
<b>Total Fat</b> 0g	<b>0%</b>
Saturated Fat 0g	<b>0%</b>
<i>Trans</i> Fat 0g	
<b>Cholesterol</b> 0mg	<b>0%</b>
<b>Sodium</b> 10mg	<b>0%</b>
<b>Total Carbohydrate</b> 24g	<b>8%</b>
Dietary Fiber 1g	<b>4%</b>
Sugars 23g	
<b>Protein</b> 0g	
Vitamin A 2%	• Vitamin C 2%
Calcium 0%	• Iron 0%

## 11 – Banana Chips

<b>Nutrition Facts</b>	
Serving Size 1 oz (308g)	
Servings Per Container 8	
Amount Per Serving	
<b>Calories</b> 150	Calories from Fat 78
% Daily Value*	
<b>Total Fat</b> 8g	<b>12%</b>
Saturated Fat 6g	<b>30%</b>
<i>Trans</i> Fat 0g	
<b>Cholesterol</b> 0mg	<b>0%</b>
<b>Sodium</b> 0mg	<b>0%</b>
<b>Total Carbohydrate</b> 18g	<b>6%</b>
Dietary Fiber 1g	<b>4%</b>
Sugars 2g	
<b>Protein</b> 0g	
Vitamin A 0%	• Vitamin C 0%
Calcium 2%	• Iron 0%

Lower  
calorie  
choice

Number  
of calories  
saved

## 12 – Dried Prunes

<b>Nutrition Facts</b>	
Serving Size 5 prunes (1.43 ounces)	
Servings Per Container 14	
Amount Per Serving	
<b>Calories</b> 45	Calories from Fat 0
% Daily Value*	
<b>Total Fat</b> 0g	<b>0%</b>
Saturated Fat 0g	<b>0%</b>
<i>Trans</i> Fat 0g	
<b>Cholesterol</b> 0mg	<b>0%</b>
<b>Sodium</b> 5mg	<b>0%</b>
<b>Total Carbohydrate</b> 24g	<b>8%</b>
Dietary Fiber 3g	<b>12%</b>
Sugars 12g	
<b>Protein</b> 1g	
Vitamin A 8%	• Vitamin C 0%
Calcium 2%	• Iron 2%

\* **Percent Daily Values** are based on a 2,000-calorie diet. Your Daily Values may be higher or lower depending on your calorie needs.

# Lumpiang Sariwa (Fresh Lumpia) Recipe

½ cup	cabbage, julienned	1. Heat oil, and saute ground meat with the shrimp and garlic.
½ cup	green beans, julienned	2. Add vegetables until slightly crisp. Pour in the chicken broth until cooked.
½ cup	carrots, julienned	3. Season with salt and pepper.
¼ cup	celery, julienned	4. Set aside, and drain in a colander.
¼ cup	<i>jicama</i> ,* julienned	5. Save the broth for the <i>lumpia</i> sauce.
½ cup	ground chicken or lean pork	6. Soak the Vietnamese spring roll wrappers one at a time in water until soft and transparent. Dry immediately with a paper towel.
½ cup	shrimp, cleaned and deveined	7. Lay the lettuce on the wrapper.
½ cup	chicken broth	8. Place 2 tablespoons of the vegetable mixture on the wrapper.
8 pieces	red leaf lettuce	9. Fold in one side of the wrapper and roll tightly.
8	Vietnamese spring-roll wrappers or <i>lumpia</i> wrappers	10. Serve with <i>lumpia</i> sauce on top. Sprinkle with chopped peanuts.
2 cloves	garlic, chopped	
¼ teaspoon	salt	
¼ teaspoon	pepper	
⅓ cup	dry roasted peanuts, chopped	
1 tablespoon	olive oil	

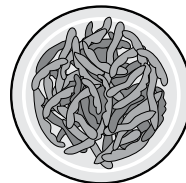
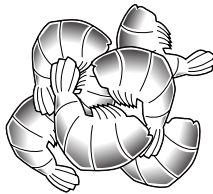

\* *Jicama* looks similar to a turnip or a large radish. The water chestnut can be used as an alternative.

Source: Philippine Heart Center's Healthy Heart Cookbook.

# *Lumpiang Sariwa (Fresh Lumpia)*

## Recipe *(continued)*

### Lumpia Sauce

1 cup	broth from the sauteed vegetables	1. Mix vegetable broth, soy sauce, brown sugar, and garlic together, and bring to a boil.
1 tablespoon	light soy sauce	
1 tablespoon	brown sugar	2. Mix the cornstarch in 2 tablespoons of cold water.
3 cloves	garlic, minced	
1 teaspoon	cornstarch	3. Slowly add the cornstarch mixture to the broth. Stir until sauce thickens.
2 tablespoons	cold water for mixing cornstarch	

#### Quick Facts

Your family will love this tasty recipe. The ingredients—ground chicken or pork, olive oil, peanuts, and fresh herbs and spices—add flavor. Also, the *lumpiang sariwa* is served fresh so it has fewer calories than fried *lumpiang*.

Yield:	Serving size:
<b>8 servings</b>	<b>1 lumpia</b>
Calories	160
Total Fat	4 g
Saturated Fat	0.5 g
Cholesterol	55 mg
Sodium	150 mg
Total Fiber	2 g
Protein	10 g
Carbohydrates	21 g
Potassium	170 mg

Source: *Mula sa Pusa*, Heart Healthy Traditional Filipino Recipes, American Heart Association, 1999.

# Lola's Life Lessons: Session 6

---

One of my favorite proverbs is:

*“Ang buhay ay parang gulong minsang nasa ibabaw, minsang nasa ilalim.”*

Translation: “Life is like a wheel; sometimes you are on top, sometimes you are on the bottom.”

Keeping your weight in the healthy range is important for heart health. Six months ago, our family set a goal. My kids made a pact to lose weight and live healthier lifestyles. Since I lost 20 pounds (9.1 kilograms) last year, my family sees that even old ladies like me can lose weight! They have helped me stay healthy, and now I am helping them.

Over the past few months, I have watched them struggle. I tell them that losing weight takes patience. Sometimes you are on top, and sometimes you are on the bottom. The key to losing weight is finding the right balance of physical activity and healthy eating. *Ang umaayaw ay di nagwawagi, ang nagwawagi ay di umaayaw.* (“A quitter never wins, a winner never quits.”) It can be frustrating, because it takes time and commitment to stay healthy.

Luckily, Mila helps me cook healthier meals, and Victoria is my faithful walking partner. I have found that if you have the patience and support of family and friends, you will find the right balance to help you achieve a heart healthy weight!

## **A Time To Reflect...**

What keeps you from maintaining a healthy weight? What changes can you make to have a balanced life?

(Use this space to write down your thoughts for this week's session.)

# Pledge for Life! Session 6

---

Take the pledge for life with Lola Idad. Try to do at least one of these activities by yourself or share them with others.

- Know your BMI number.
- Know your waist measurement.
- Know the appropriate serving sizes for food and drinks.
- Shop for low-fat, low-calorie foods and drinks using the Nutrition Facts label.
- Choose a variety of fruits (fresh, frozen, or canned in fruit juice) and unsalted nuts for healthy snacks.
- Exchange heart healthy recipes with your friends and family.
- Avoid taking second helpings of food.
- When eating out, go to buffets less often. When getting carryout food, make healthy choices and select smaller serving sizes.
- Support your friends and family in their efforts to maintain a healthy weight.
- Other \_\_\_\_\_

# Protect Your Heart: Prevent and Control Diabetes

---

## Objectives

**By the end of this session, group members will learn:**

- What diabetes is and how it affects the body
  - The symptoms of diabetes
  - That diabetes is a major risk factor for heart disease
  - The levels of blood glucose (blood sugar) and what they mean
  - How to prevent and control diabetes
  - The amount of sugar in common beverages
- 

## Materials and Supplies

**To conduct this session, you will need:**

- “Healthy Heart, Healthy Family” manual and picture cards
- Blackboard and chalk or several large pieces of paper, a marker, and tape
- Two clear plastic bottles of water\*
- Red food coloring\*

---

\*Prepare before the session (see page 242).

- 1 cup of corn syrup\*
- A box of sugar cubes\*
- Three manila file folders for activity display\*
- Pictures of drinks listed on page 277\*
- Glue\*



*(Optional) Note:* Arrange for a health professional or a diabetes educator to come to the session to measure group members' blood glucose levels.

---

## Handouts

### Give group members these handouts during this session:

- List of places where group members can get their blood glucose checked†
- “What Is Diabetes?” (page 260)
- “Are You at Risk for Type 2 Diabetes?” (page 261)
- *(Optional)* “Take These Small Steps Now To Prevent Diabetes” (page 262)
- *(Optional)* “Rose Learns About Preventing Diabetes” (page 263)
- “Symptoms of Diabetes” (page 264)
- “Be Good to Your Heart: Know Your Blood Glucose Level” (pages 265–266)
- “Tender Care for Your Feet” (page 267)
- “Be Smart About Your Heart: Control the ABCs of Diabetes” (pages 268–270)
- Read the Nutrition Facts Label for Sugar! (pages 271–273)

---

\* Prepare before the session (see pages 242, 253, and 277).

† Prepare this list before the session. You may find information at your local health department, hospital, or clinic.

- Mila’s Food Choices (pages 274–276)
  - Think Before You Drink: Hidden Sugar in Common Beverages (page 277)
  - How Much Sugar and How Many Calories Are in Your Favorite Drink? (page 278)
  - *Pesang Isda* (Fish Simmered With Ginger and Tomatoes) Recipe and *Munggo Gisado* (Sauteed Mung Beans) Recipe (pages 279–280)
  - Lola’s Life Lessons: Session 7 (page 281)
  - Pledge for Life! Session 7 (page 282)
- 

## **Session Outline**

### **Introducing the Session**

1. Welcome
2. Review of Last Week’s Session
3. About This Session

### **Conducting the Session**

1. The Facts Don’t Lie
2. What Is Diabetes?
  - What is Prediabetes?
3. Types of Diabetes
4. Risk Factors for Diabetes
5. Symptoms of Diabetes
6. Blood Glucose Levels
  - A. Hypoglycemia
  - B. Hyperglycemia



7. Complications of Diabetes
8. ABCs of Diabetes Control
9. Nutrition Facts Label Activity—Sugar
10. Think Before You Drink—Hidden Sugar in Drinks Activity
11. *Pesang Isda* (Fish Simmered With Ginger and Tomatoes) and *Munggo Gisado* (Sauteed Mung Beans) Recipe Activity

## **Review of Today’s Key Points**

### **Lola’s Life Lessons: A Time To Reflect**

### **Pledge for Life!**

### **Closing**

## Introducing the Session

---

### **1. Welcome**

- Welcome group members to the session.

### **2. Review of Last Week’s Session**

- Say:

At the last session, we talked about aiming for a healthy weight.

■ **Ask these questions:**

**Q: Does anyone remember why a healthy weight is important to your heart health?**

**A:** Keeping a healthy weight reduces your risk of heart disease, stroke, high blood pressure, high blood cholesterol, and diabetes.

**Q: What is the healthiest way to lose weight?**

**A:** Eat smaller portions of a variety of foods lower in fat and calories, and increase your physical activity.

**Q: How does the Nutrition Facts label help people who are trying to lose weight?**

**A:** The Nutrition Facts label tells you the serving size and the number of calories in a serving.

■ **Say:**

At the end of last session, you made a pledge to do something to help you keep or reach a healthy weight. What problems did you have? How did you deal with any problems?



**Note:** Allow 2 minutes for group members to respond.

### **3. About This Session**

■ **Say:**

In today's session, we will learn what we can do to prevent and control diabetes. If you have diabetes, you will need to work closely with a doctor, a registered dietitian, or a certified diabetes educator to help you monitor and control your blood glucose.

■ **Say:**

Lola Idad's family often thought that these changes were impossible, but Lola always reminds them that "*Sa taong walang takot, walang mataas na bakod.*" "To a fearless person, no fence is too high."

■ **Say:**

In this session, Lola’s family will share the lessons they have learned through their experiences, to help us on our journey to heart health.

## Conducting the Session

### 1. The Facts Don’t Lie

■ **Say:**

- Diabetes is a serious problem for Filipino families. It affects men, women, and children.
- A study in San Diego County found that one out of every three Filipinas has diabetes.
- More than half of the Filipinas with diabetes do not know they have diabetes.
- Most Filipinas with diabetes (about 90 percent) are not obese (their BMIs are less than 30 kg/m<sup>2</sup>).
- Diabetes is a chronic disease that slowly damages the body. Although it has no cure, complications can be prevented.
- Diabetes is a major risk factor for heart disease.

### 2. What Is Diabetes?

■ **Say:**

Now we will talk about what diabetes is and the types of diabetes.

- **Give** group members the “What Is Diabetes?” handout (page 260).



■ **Say:**

Diabetes happens when the body does not make enough insulin or cannot use it well, causing glucose to build up in the blood. Too much glucose in the blood is not good for your health. As a result, the body does not function well.

■ **Show picture card 7.1.**

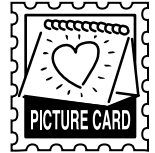

■ **Say:**

In a healthy body, the food we eat goes to the stomach, where it is digested. The food is broken down into blood glucose. Blood glucose is also called blood sugar.

■ **Say:**

The blood takes the glucose to the cells of your body, where it is turned into the energy needed for daily life. However, glucose cannot enter the cells alone. Insulin, a hormone made in the pancreas, helps glucose enter the cells.

■ **Show picture card 7.2.**

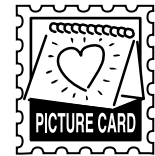

■ **Say:**

Diabetes happens when the body does not produce enough insulin, or when the cells cannot use the insulin well. This means that the glucose cannot enter the cells and it builds up in the blood. People who have high levels of glucose in their blood have diabetes.

## **What Is Prediabetes?**

■ **Ask:**

What is prediabetes?



**Note:** Allow a minute for group members to respond.

■ **Add** these answers if they are not mentioned:

- Prediabetes is a condition in which blood glucose levels are higher than normal, but not high enough to be diabetes.
- People with prediabetes are more likely to develop diabetes within the next 10 years.
- People with prediabetes are also more likely to have a heart attack or stroke.

### 3. Types of Diabetes

■ **Show picture card 7.3.**

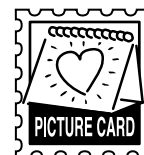

■ **Say:**

When a person does not have diabetes, the pancreas produces a healthy amount of insulin, which the body can use. This is shown in the first picture.

■ **Say:**

There are two main types of diabetes.

■ **Say:**

#### **Type 1 diabetes:**

- Happens when the pancreas no longer produces insulin. This is shown in the second picture.
- Requires an insulin pump or shots every day.
- Is usually found in children, adolescents, or young adults.
- Affects about 5 to 10 percent of those with diabetes.

■ **Say:**

#### **Type 2 diabetes:**

- Happens when some insulin is produced, but the body cannot use it well. This is shown in the third picture.

- Happens more often in people who are overweight and are not physically active.
- Is usually treated with diet pills or, sometimes, insulin shots.
- Can occur at any age, but is more common after age 40.
- Is increasing among children, especially if they are overweight.
- Affects 90 to 95 percent of people with diabetes.

■ **Say:**

Gestational diabetes is a special class of type 2 diabetes.

- Some pregnant women develop this kind of diabetes, but it usually disappears after the baby is born.
- Overweight women and women who have a family history of diabetes are also at higher risk for gestational diabetes.
- Women who have had gestational diabetes have a much higher chance of developing type 2 diabetes later in life. Their children are also at a higher risk for becoming overweight and developing diabetes.

■ **Say:**

We have talked about healthy living throughout the sessions. Type 2 diabetes can be prevented and controlled by making healthy food choices, being physically active, and taking medication as prescribed by your doctor. If you have diabetes, it is important to be under a doctor's care and to check your blood glucose as your doctor tells you.

■ **Say:**

Now we are going to do an activity to better understand what diabetes is. We will see the difference between normal blood and blood with a high blood glucose level.

## Before the session:

### Prepare the Blood Glucose Demonstration

1. Put two clear plastic bottles on the table.
2. Add 1 cup of water and 3 drops of red food coloring into one of the bottles. This represents blood with normal blood glucose.
3. Add 1 cup of corn syrup and 3 drops of red food coloring into the other bottle. This represents blood with high blood glucose.

■ **Show** the plain water bottle, and slowly **tilt** it from side to side to show the smooth movement of the liquid.

■ **Say:**

Notice how the liquid moves easily and freely. This represents the blood of someone with normal blood glucose.

■ **Show** the bottle with corn syrup, and slowly **tilt** the bottle from side to side to show the slow movement of the liquid.

■ **Say:**

Notice how slowly the blood moves and how thick it is when the blood glucose level is high. This represents the blood of someone with high blood glucose. The glucose stays in the blood instead of being used by the body's cells and muscles.

## 4. Risk Factors for Diabetes

■ **Ask:**

What are some risk factors that increase your chances of getting diabetes?



**Note:** Allow about 3 minutes for group members to respond. **Write** their answers on the blackboard or on a large piece of paper taped to the wall.

■ **Show picture card 7.4.**

- **Give** group members the “Are You at Risk for Type 2 Diabetes?” handout (page 261). As you read each risk factor, ask group members to make a checkmark next to the risk factors they have.

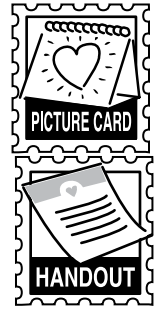

■ **Say:**

Your chances of getting diabetes increase if you:

- Are overweight, especially if you have extra weight around the waist.
- Have a parent or sibling with diabetes.
- Are Asian American, Native Hawaiian or other Pacific Islander, African American, Latino, or American Indian.
- Have had gestational diabetes or have given birth to at least one baby weighing more than 9 pounds (4.1 kg).
- Have blood pressure that is 140/90 mmHg (millimeters of mercury) or higher or have been told by a health care provider that you have high blood pressure.
- Have cholesterol levels that are not normal, that is, a level of HDL (high-density lipoprotein) cholesterol (“good” cholesterol) of 35 mg/dL (milligrams per deciliter) or lower, or a triglyceride level of 250 mg/dL or higher.
- Are not very active (participate in physical activity less than three times a week).

■ **Say:**

The good news is that, if you are at risk for diabetes, you can prevent or delay getting diabetes by being physically active and having a healthy weight.

It is important to be physically active for 30 minutes on most days and to lose even a small amount of weight. For example, someone who weighs 200 pounds (90.7 kg) would benefit from losing 10 to 15 pounds (4.5 to 6.8 kg).



- (Optional) Give group members the “Take These Small Steps Now To Prevent Diabetes” handout (page 262). Review the handout with the group.



- (Optional) Give group members the “Rose Learns About Preventing Diabetes” handout (page 263). Ask for three volunteers to read the role play. As the trainer, you can read the introduction.

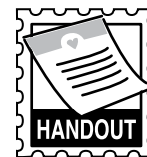

**Note:** Allow 5 minutes for discussion.

- Ask the following questions:
  - What are some of the lessons we learned from this role play?
  - Is there any part of the play that you can use in your own life?

## 5. Symptoms of Diabetes

- **Ask:**

Does anyone know the signs or symptoms of diabetes?

**Note:** Allow 3 to 5 minutes for group members to answer.

- Give group members the “Symptoms of Diabetes” handout (page 264).



- Show picture card 7.5.

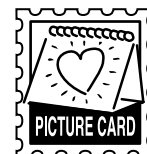

- **Say:**

Now let's review the symptoms of diabetes:

- Feeling tired
- Increased thirst
- Frequent urination
- Increased hunger
- Unexplained weight loss
- Very dry skin
- “Pins and needles” feeling in feet
- Sores that don't heal
- Blurry vision
- Feeling irritable

■ **Say:**

Often, people with type 2 diabetes have no symptoms. If you have one or more symptoms, see your doctor right away.

## 6. Blood Glucose Levels

■ **Show picture card 7.6.**

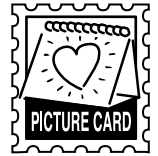

■ **Say:**

To find out if you have diabetes, you can take a fasting blood glucose test at the doctor's office or at a lab.

■ **Give group members the “Be Good to Your Heart: Know Your Blood Glucose Level!” handout (pages 265–266).**



■ **Say:**

- A fasting blood glucose level below 100 mg/dL is normal. You are in good shape.
- A fasting blood glucose level of 100 to 125 mg/dL is prediabetes. This is a warning that you are at risk for developing type 2 diabetes. It is time to lose weight and be physically active at least 5 days a week.
- A fasting blood glucose level of 126 mg/dL or higher means that you have diabetes. If you have diabetes, you should work with your doctor and other health care providers to learn to control it. It is important to work with your doctor to learn the ABCs (A1C test, blood pressure, and cholesterol) of controlling diabetes. We will learn about the ABCs of diabetes control later in this session.

■ **Say:**

You can also get a nonfasting glucose test at health fairs and other sites in your community. This is done using a glucometer and a small amount of blood. A nonfasting blood glucose level of 200 mg/dL or higher could mean that you have diabetes. See your doctor to get a fasting blood glucose test. You must fast for at least 8 hours before the test.

### More Information: Fasting Blood Glucose Levels

Level	Fasting Blood Glucose	1–2 Hours After Meals	Results
Normal	70–99 mg/dL	70–139 mg/dL	Good for you!
Prediabetes	100–125 mg/dL	140–199 mg/dL	This is a warning that you are at risk for type 2 diabetes. A blood glucose level in this range is higher than normal, but not high enough to be diabetes. You need to take action to prevent diabetes.
Diabetes	126 mg/dL or higher	200 mg/dL or higher	You have diabetes. Work with your doctor and other health care providers to control the ABCs (A1C, blood pressure, and cholesterol).

■ **Say:**

People with diabetes may experience problems if their blood glucose levels get too low or too high.

#### **A. Hypoglycemia**

■ **Say:**

Hypoglycemia is a condition that develops when a person’s blood glucose level is too low. People with diabetes may develop hypoglycemia.

■ **Say:**

People with diabetes may develop hypoglycemia when they:

- Skip or delay a meal or eat very little.
- Take too much insulin or oral diabetes medicine.

- Do too much physical activity.
- Drink alcohol.

■ **Say:**

The symptoms of hypoglycemia are:

- Headache
- Feeling shaky
- Feeling anxious
- Dizziness
- Feeling weak
- Feeling irritable

■ **Say:**

People with diabetes should talk to their health care providers to learn what to do for low blood glucose.

■ **Say:**

People with diabetes may suffer from hypoglycemia. If your blood glucose is below 70 mg/dL, your health care provider may tell you to do one of the following:

- Drink ½ cup of fruit juice.
- Drink 1 cup of milk.
- Take two to three glucose tablets.
- Eat 2 teaspoons of sugar or honey.

## **B. Hyperglycemia**

### **■ Say:**

Hyperglycemia is a condition that occurs when a person's blood glucose level is too high. People with diabetes may develop hyperglycemia when they:

- Eat too much food.
- Are less active than usual.
- Have not taken their medicine.
- Are sick or feel tension and stress.

### **■ Say:**

The symptoms of hyperglycemia are:

- Increased thirst
- Frequent urination
- Dry skin
- Increased hunger
- Blurry vision
- Feeling tired
- Nausea

### **■ Say:**

People with diabetes should talk to their health care providers about what to do if they experience the effects of high blood glucose.

If your blood glucose is too high, your health care provider may need to change your medication or eating plan.

## 7. Complications of Diabetes

### ■ Say:

Diabetes can cause changes in the body. These changes can cause problems, called complications. Can anyone name any complications of diabetes?



**Note:** Allow 3 to 5 minutes for group members to respond. **Write** their answers on the blackboard or on a large piece of paper taped to the wall.

### ■ Say:

Over time, diabetes can affect the large blood vessels in the brain, heart, legs, and feet. It also can affect the small blood vessels in the kidneys and eyes.

Diabetes can lead to:

- Heart attack
- Stroke
- Amputation of the feet or legs—Diabetes can cause nerve damage. The first sign of nerve damage is the loss of sensation in the feet or legs. If you have nerve disease, you may lose feeling or have tingling or pain in your toes, feet, or legs.
- Kidney disease—With diabetes, the excess glucose in the blood damages the blood vessels inside the kidneys. Filipino Americans are four times more likely than Caucasians to develop kidney failure, the final stage of kidney disease.
- Eye disease—Diabetes can harm your vision or even cause blindness. People with diabetes need to have their eyes examined by a medical eye doctor once a year.
- Dental problems—An increase in cavities and tooth infections is common in people with poor diabetes control. To prevent tooth decay, brush and floss your teeth every day. See your dentist every 6 months.

■ **Say:**

Over time, diabetes can affect all parts of the nervous system. This can lead to:

- Loss of strength in muscles
- Changes in digestion, bladder control, and sexual function
- Loss of feeling in the feet—This is why you need to keep your feet clean, dry, soft, and protected.

■ **Give** and review the “Tender Care for Your Feet” handout (page 267).



## **8. ABCs of Diabetes Control**

■ **Say:**

If you have diabetes, controlling your blood glucose levels can help prevent or delay complications.

■ **Say:**

We've learned that people with diabetes have a greater chance of having a heart attack or stroke. Let's find out how to take care of the heart with the ABCs of diabetes control.

■ **Give** and review the “Be Smart About Your Heart: Control the ABCs of Diabetes” handout (pages 268–270).



■ **Say:**

Be sure to ask your doctor:

- What are my ABC numbers?
- What should my ABC numbers be?
- What actions should I take to control my ABC numbers?

■ **Say:**

Knowing about diabetes can help prevent or delay it. For those who already have diabetes, diabetes education can help reduce the complications the disease can cause.

## 9. Nutrition Facts Label Activity—Sugar



■ **Say:**

People with diabetes should control their sugar intake, because sugar is high in calories and contributes to weight gain. Eating too much sugar can also lead to increased blood glucose levels in those with diabetes.

■ **Say:**

Now let's do an activity that will help us use Nutrition Facts labels to find foods that have less sugar.

- **Give** group members the “Read the Nutrition Facts Label for Sugar!” handout (pages 271–273).



■ **Say:**

This handout shows the amount of sugar in some drinks and food. Look at the bottom of the handout. Which drink has fewer grams of sugar—mango nectar or unsweetened iced tea?

■ **Say:**

The iced tea has less sugar. One cup of mango nectar has 50 grams of sugar, compared to 0 grams of sugar in 1 cup of unsweetened iced tea.



**Note:** Unlike other nutrients, sugar does not have a Percent Daily Value on the Nutrition Facts label.

■ **Say:**

Let's try another activity. Mila needs our help.



- Give group members the “Mila’s Food Choices” handout (pages 274–276).



- Say:

First, I am going to read about Mila’s problem. Then we will use the Nutrition Facts labels to find some solutions.

### Mila’s Food Choices

Mila has offered to go grocery shopping for her mother, Lola Idad, who is home sick with the flu. Lola also has diabetes. Mila wants to buy foods that are lower in calories and sugar to help her mother. Look at the Nutrition Facts labels. Help Mila select foods that are lower in sugar. Which foods should Mila buy? Write the number of your choice for each pair. Then write the number of grams of sugar saved by this choice.



**Note:** The correct answers to the questions are underlined. The sugar and calories saved by making the right choice are given below the choices.

Pan de Sal (Filipino roll) or a doughnut

Choosing the *pan de sal* saves 14 grams of sugar.

Gelatin or sugar-free gelatin

Choosing the sugar-free gelatin saves 19 grams of sugar.

Regular ice cream or fat-free, no-sugar-added ice cream

Choosing the fat-free, no-sugar-added ice cream saves 90 calories.

Diet soda or regular soda

Choosing diet soda saves 39 grams of sugar.

*Bibingka* (sweet rice cake) or cooked oatmeal

Choosing the cooked oatmeal saves 44 grams of sugar.

## 10. Think Before You Drink—Hidden Sugar in Drinks Activity



**Note:** Prepare before the session.

1. Look at the box that appears below. Use drawings or empty cans or bottles to represent these drinks.
2. Prepare five separate displays for each of the five drinks.
3. Follow these instructions to prepare each display:
  - Cut a folder into two parts, folding each part in half to make a card (tent).
  - Write the name of the drink on one side. On the other side, write the number of calories, grams of sugar, and teaspoons of sugar in the drink. Glue the cubes of sugar onto the folder to show the number of teaspoons of sugar in each drink. To get the number of teaspoons, divide the grams of sugar on the food label by four. Examples of the displays are shown on page 277.
4. Hide the displays until it is time to do the activity.

Serving Size	Drink	Amount of Sugar
12 ounces	Powdered drink mix with sugar	9 teaspoons (36 grams)
12 ounces	Diet soda	0 teaspoons (0 grams)
12 ounces	Grape juice	8 teaspoons (32 grams)
12 ounces	Regular soda	9¼ teaspoons (39 grams)
12 ounces	Mango nectar	12½ teaspoons (50 g)
8 ounces	Energy drink	6¼ teaspoons (25 g)

## Group Activity

### ■ Say:

We are going to play a guessing game to learn how much sugar is in some common beverages.

- Give group members the “Think Before You Drink—Hidden Sugar in Common Beverages” handout (page 277).

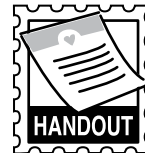

- Show group members the front of each of the five cards that you prepared before the session, showing them the names of the beverages.

### ■ Say:

Guess how many teaspoons of sugar are in each drink. Write your answers on the handout I gave you.



**Note:** Allow 2 minutes for group members to **write** down their answers.

- Ask group members to share the amounts of sugar that they guessed. After the group members have shared the amounts they guessed, **show** them the actual number of teaspoons of sugar that are in each drink. **Pass** around the cards one by one.

### ■ Say:

During the second part of this activity, you will learn how much sugar and calories are in your favorite drink.

- Give group members the “How Much Sugar and How Many Calories Are in Your Favorite Drink?” handout (page 278).



### ■ Say:

Find your favorite drink on the list. Look to see how much sugar and how many calories are in it. Many drinks have a high amount of sugar and calories.

■ **Say:**

As you can see, it is easy for people who choose drinks with sugar to get too many calories. Getting too many calories leads to weight gain. Try to drink more water or unsweetened drinks instead of drinks with sugar or regular sodas.

**11. *Pesang Isda (Fish Simmered With Ginger and Tomatoes)* and *Munggo Gisado (Sauteed Mung Beans)* Recipe Activity**



■ **Say:**

With simple changes to traditional foods, Lola Idad and her family learned that heart healthy Filipino food tastes good.

■ **Give** group members the following recipe handouts:

“*Pesang Isda (Fish Simmered With Ginger and Tomatoes)*

Recipe” and “*Munggo Gisado (Sauteed Mung Beans)*

Recipe” (pages 279–280). **Ask** them to prepare one or more

of them during the coming week. **Tell** them that using the recipes will give them a chance to practice some of the ideas from the session.



■ **Ask:**

How are these recipes heart healthy?

■ **Add** the answers below if they are not mentioned:

- The main dish is made with fish.
- The side dish is made with vegetables, seafood, and lean meat.
- The fish is simmered in water, not fried.
- No fat is added to the fish and only a tablespoon of corn oil is added to the mung beans.

— Additional flavoring with herbs and spices

— Cooked and simmered slowly in moist heat

■ **Say:**

Remember that foods lower in fat still contain calories. Check the portion size. If you eat these foods in large quantities, you may gain weight.

## Review of Today's Key Points

---

■ **Say:**

Let's review what we learned today.

**What is diabetes?**

- Diabetes happens when the body does not make enough insulin or cannot use it well, causing glucose to build up in the blood. As a result, the body does not function well.

**What are risk factors for diabetes?**

- Overweight
- Family members with diabetes
- Age 40 or older
- Not being physically active
- Being Latino, African American, American Indian, Asian American, or Native Hawaiian or other Pacific Islander (because diabetes occurs more often in people from these groups than in Caucasians)
- Having had gestational diabetes or given birth to at least one baby weighing 9 pounds (4.1 kg) or more
- High blood pressure
- Cholesterol levels are not normal—HDL cholesterol is low or triglycerides are high

## **How can you prevent or delay type 2 diabetes?**

- Be physically active for 30 minutes on most days.
- Lose a small amount of weight. For example, losing 10 to 15 pounds (4.5 to 6.8 kg) is helpful for someone who weighs 200 pounds (90.7 kg).

## **What are the ABCs of diabetes control?**

- A is for the A1C test. If you have diabetes, take the A1C blood test at least two times every year. This test measures how well a person's blood glucose level has been controlled over the past 3 months. People who have diabetes should aim for an A1C number that is below seven.
- B is for blood pressure. High blood pressure makes your heart work too hard. It increases your risk for a heart attack, stroke, or damage to your kidneys and eyes. A person with diabetes should have a blood pressure below 130/80 mmHg.
- C is for cholesterol. Keep cholesterol at normal levels. Bad cholesterol (LDL) can build up and clog your arteries. It can cause a heart attack. People with diabetes need to keep their LDL cholesterol below 100 mg/dL.

## **How does diabetes affect your body?**

- Diabetes can cause damage to the heart, brain, kidneys, and eyes. It can cause nerve damage, which reduces sensation in your feet. Diabetes may also affect blood flow in your legs and feet. This can lead to sores that don't heal and amputation. Good control of your blood glucose can prevent this damage.

# Lola's Life Lessons: A Time To Reflect

## ■ Say:

Like many families, the de la Cruz family needs to make lifestyle changes. Lola Idad's kids are busy with work and making sure that their children are safe and well educated. Lola encourages her family to stay on the heart healthy path to help prevent their risk for diabetes. She and the family learn to prepare heart healthy meals and plan time for the family to be more physically active.

- Give each group member the "Lola's Life Lessons: Session 7" handout (page 281). Ask a volunteer to read the handout.



## ■ Say:

Please take a few moments to reflect on Lola's advice and how this applies to your life. At the bottom of the handout, there is a space called "A Time To Reflect." Use this section to record your thoughts and feelings about this week's session. Remember, this is for you and no one else.

# Pledge for Life!



- Give each group member the "Pledge for Life! Session 7" handout (page 282).



## ■ Say:

Take the pledge for life with Lola Idad. She and her family have taken the pledge to lower their risk of getting diabetes. Take the step toward losing weight if overweight, eating healthy foods, getting regular physical activity, and keeping blood sugar within the normal range. Pledge to do one thing on this list during the coming week.



**Note:** Give each group member 2 to 3 minutes to share.

■ **Say:**

We will talk about how you did with your pledges at the next session. Remember to keep working on your pledges to be more active.

■ *(Optional—*if you can get a health professional to come to your session)

■ **Tell** group members that a health professional will now check their blood sugar.

## Closing

---

■ **Say:**

Thank you for coming today. What did you think of today's session?



**Note:** Allow a moment for group members to respond.

■ **Say:**

I am looking forward to seeing you at the next session. The next session will be about making heart healthy eating an everyday family affair.



**Note for Educator:** Think about today's session. What worked? What didn't work? Have you made changes in your own life to prevent and control diabetes as a result of today's session?



# What Is Diabetes?

Diabetes happens when the body does not make enough insulin or cannot use it well. This causes glucose to build up in the blood. As a result, the body does not function well.

## Know your body

- The food we eat goes to the stomach, where it is digested. The food is turned into blood glucose in the body. Blood glucose is also called blood sugar. The body uses glucose to provide energy needed for daily life.
- The blood takes the glucose to the cells where it is turned into energy. However, glucose cannot enter the cells alone; it needs help. Insulin helps the glucose enter the cells. Insulin is a hormone that is made in the pancreas.
- If the body does not produce enough insulin, or if the cells cannot use the insulin well, then the glucose cannot enter the cells and it builds up in the blood.
- People who have high levels of glucose in their blood have prediabetes or diabetes.

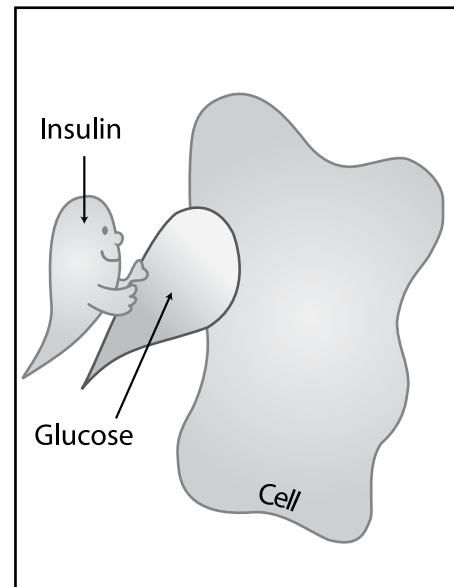
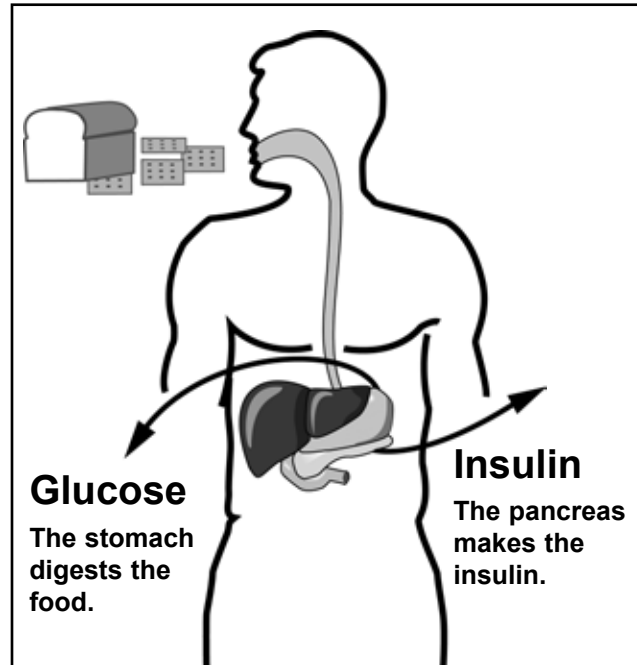

# Are You at Risk for Type 2 Diabetes?

---



Name: \_\_\_\_\_

Check the risk factors you have. The more risk factors you check, the higher your risk for developing type 2 diabetes. Only your health care provider can determine if you have diabetes. On your next visit, find out for sure.

- I am overweight (especially if I have extra weight around the waist).
- I have a parent, brother, or sister with diabetes.
- My family background is Asian American, Native Hawaiian or other Pacific Islander, Latino, African American, or American Indian.
- I have had gestational diabetes, or I gave birth to at least one baby weighing 9 pounds (4.1 kg) or more.
- My blood pressure is 140/90 mmHg or higher, or I have been told by a health care professional that I have high blood pressure.
- My cholesterol levels are not normal. My HDL cholesterol (“good” cholesterol) is 35 mg/dL or lower, or my triglyceride level is 250 mg/dL or higher.
- I do very little physical activity. I exercise fewer than three times a week.

# Take These Small Steps Now To Prevent Diabetes

---

## ■ Find out if you are at risk.

Asian Americans and Native Hawaiians or other Pacific Islanders are at high risk for type 2 diabetes and are not always overweight. Talk to your health care provider about YOUR risk.

## ■ Lose a small amount of weight.

Being overweight puts you at high risk for type 2 diabetes. The weight you think is normal for you may not be a healthy weight. You can work toward a healthy weight by being more active and eating healthy.

## ■ Be more physically active.

Choose an activity you enjoy. Take a walk, swim, bike ride, dance, or play ball with your children.

## ■ Eat healthy.

Make healthy food choices and eat smaller servings. Cut down on fatty and fried foods. Choose more fruits and vegetables, dry beans, and whole grains.

## ■ Record your progress.

Every day, write down all the things you eat and drink and the number of minutes you are active. Keeping a diary is one of the best ways to lose weight and keep it off.

## ■ Keep at it.

Make one new change each week. If you get off track, start again, and keep going.

Source: Adapted from “Take These Small Steps Now To Prevent Diabetes,” National Diabetes Education Program, 2007.

# Rose Learns About Preventing Diabetes

---

**Rose has just arrived at Mila’s house. She is upset because she has just been diagnosed with prediabetes. Mila and Lola are trying to comfort her.**

**Mila:** Rose, are you okay? You look upset.

**Rose:** I just had a checkup with Dr. Cabaya, and he told me that I have prediabetes! How do I tell Jose? He will be upset.

**Mila:** My brother only wants to see you and the family healthy and strong—especially after his struggles with high blood pressure and his stroke. Think of this news in a positive way. You can still make changes now to delay or prevent diabetes.

**Rose:** I have been trying so hard to help Jose stay healthy and keep his blood pressure under control that I forgot about myself. But Dr. Cabaya told me that the whole family should be healthy, not just one person.

**Lola:** Rose, Dr. Cabaya is right. You have to stay healthy for your children and family! Remember how hard it was for Jose’s dad to change his habits when he was diagnosed with diabetes? He did not change his lifestyle, so the complications from the diabetes made his last years very hard.

**Rose:** Yes, Mama (Lola). Dr. Cabaya said I should be physically active every day, make wiser food choices, and lose some weight. He said this would help lower my blood sugar and reduce my risk for diabetes.

**Mila:** You are already helping Jose make heart healthy changes. It will be easier for you to practice these changes now, too. You could also start walking with Mama (Lola) and me on the weekends. It will be fun!

**Rose:** Yes, that’s a great idea. Maybe making these changes will not be too hard.

**Lola:** Have courage, Rose. *Sa taong walang takot, walang mataas na bakod.* “To a fearless person, no fence is too high.”

# Symptoms of Diabetes

---

The symptoms of type 2 diabetes develop over time. Some people have symptoms, and others do not. Here are some symptoms of diabetes.



Feeling tired



Sores that don't heal



Increased thirst



Very dry skin



Frequent urination



“Pins and needles”  
feeling in the feet



Increased hunger



Blurry vision



Unexplained weight loss



Feeling irritable

# Be Good to Your Heart: Know Your Blood Glucose Level

Write your fasting blood glucose level here: \_\_\_\_\_

What does your blood glucose level mean?

---

---

Fasting blood glucose level (mg/dL):

---

---

Below 100 mg/dL	<b>Normal</b> — Good for you! Keep up the good work!
100 to 125 mg/dL	<b>Prediabetes</b> — You are at risk for developing type 2 diabetes. — It is time to lose weight and be physically active at least 5 days a week.
126 mg/dL or higher	<b>Diabetes</b> — You should work with your doctor and other health care providers to learn to control it. — You should work with your doctor to learn the ABCs (A1C test, blood pressure, and cholesterol) of controlling diabetes.

# Maging Mabuti sa Iyong Puso: Alamin ang Iyong Antas ng Asukal sa Dugo

Isulat ang iyong pag-aayuno sa antas ng asukal sa dugo dito:

---

---

Ano ang ibig sabihin ng iyong antas ng asukal sa dugo?

---

---

Antas ng pag-aayuno ng asukal sa dugo (mg/dL):

---

---

Mas mababa sa 100 mg/dL	<b>Normal</b> — Mabuti para sa iyo! Ipagpatuloy ang mabuting gawain!
100 hanggang 125 mg/dL	<b>Paunang diyabetis</b> — Nasa peligro ka ng pagbuo ng type 2 diyabetis. — Oras na para magbawas ng timbang at maging aktibong pisikal ng hindi bababa sa 5 araw sa isang linggo.
126 mg/dL o mas mataas	<b>Diyabetis</b> — Dapat kang makipagtulungan sa iyong duktora at iba pang mga tagapagbigay ng pangangalaga sa kalusugan upang matutunang kontrolin ito. — Dapat kang makipagtulungan sa iyong duktora upang matutunan ang mga ABC (pagsubok na A1C, presyon ng dugo, at kolesterol) ng pagkontrol ng diyabetis.

# Tender Care for Your Feet

---



Diabetes can cause nerve damage, which reduces sensation in your feet. Diabetes may also affect blood flow in your legs and feet, making it harder for cuts and sores to heal. Small injuries may become infected and can become very serious.

---

## Daily care

- Wash your feet in warm water every day. Dry them carefully, especially between your toes.
  - Look at your feet every day to check for cuts, sores, blisters, redness, calluses, or other problems. If you cannot bend over or pull your feet up to check them, use a mirror, or ask someone else to check your feet.
  - If your skin is dry, rub lotion on your feet after you wash and dry them. Do not put lotion between your toes.
  - Smooth corns and calluses gently with an emery board or pumice stone. Do this after your bath or shower. Do not use a pocketknife or razor blade that can cut your skin.
  - Cut your toenails once a week after a bath.
- 

## Periodic foot exam

- Remind the health care provider to check your feet at every visit.
  - Get a complete foot exam once a year. If you have problems with your feet, have the health provider check them every 3 to 6 months.
- 

## Footwear

- Wear well-cushioned shoes and socks at all times. Do not go barefoot.
- Change your socks every day, and make sure they are clean and soft.
- Buy shoes that are roomy and allow your feet to “breathe.”
- Medicare provides coverage of special shoes for people with diabetes. Check with your doctor to see if you qualify.



# Be Smart About Your Heart: Control the ABCs of Diabetes

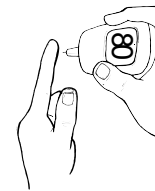

Some people have prediabetes, which is when blood glucose levels are higher than normal, but not in the diabetes range. People with this condition can reduce the risk of developing diabetes by losing a small amount of weight and increasing their physical activity.

If you have diabetes, controlling your blood glucose levels will help prevent complications.

## The ABCs of Diabetes

If you have diabetes, three key steps can help you better manage your diabetes and lower your risk of heart attack and stroke. Follow these ABCs:

- A is for the A1C test**, which is short for hemoglobin A1C. This test measures your average blood glucose over the previous 3 months. It lets you know if your blood glucose level is under control. Get this test at least twice a year. **Number to aim for:** below 7

Date				
Result				

- B is for blood pressure.** The higher your blood pressure, the harder your heart has to work. Get your blood pressure measured at every doctor's visit. **Numbers to aim for:** below 130/80 mmHg

Date				
Result				

- C is for cholesterol.** Maintain a normal cholesterol level. "Bad" cholesterol, or LDL, builds up and clogs your arteries. Get your LDL cholesterol tested at least once a year. **Number to aim for:** below 100 mg/dL

Date				
Result				

## Be sure to ask your doctor:

- What are my ABC numbers?
- What should my ABC target numbers be?
- What actions should I take to reach my ABC target numbers?

**Write the changes you will make this week to control your blood glucose, blood pressure, or cholesterol.**

\_\_\_\_\_

(Date)

\_\_\_\_\_

(Date)

# Maging Matalino sa Pangangalaga ng Iyong Puso: Kontrolin ang mga ABC ng Diyabetis

Ang ilang mga tao ay mayroong paunang diyabetis, na kapag ang mga antas ng asukal sa dugo ay mas mataas sa normal, ngunit hindi sa saklaw ng diyabetis. Ang mga taong may ganitong kundisyon ay maaaring bawasan ang peligro ng pagbuo ng diyabetis sa pamamagitan ng pagbabawas ng kaunting timbang at pagdaragdag ng kanilang pisikal na aktibidad.

Kung mayroon kang diyabetis, ang pagkontrol sa iyong antas ng asukal sa dugo ay makatutulong na maiwasan ang mga komplikasyon.

## Ang mga ABC ng Diyabetis

Kung mayroon kang diyabetis, ang tatlong pangunahing hakbang ay maaaring makatulong sa iyo na mahusay na mapamahalaan ang iyong diyabetis at babaan ang iyong peligro ng pagkakaroon ng atake sa puso at stroke. Sundin ang mga ABC na ito:

- **Ang A ay para sa pagsubok na A1C**, na pinaikling hemoglobin A1C. Sinusukat ng pagsubok na ito ang iyong katamtamang asukal sa dugo sa nakaraang 3 buwan. Ipinapaalam nito sa iyo kung ang iyong antas ng asukal sa dugo ay nakokontrol. Kunin ang pagsubok na ito ng hindi bababa sa dalawang beses sa isang taon.

**Bilang na dapat hangarin:** mas mababa sa 7

<b>Petsa</b>							
<b>Resulta</b>							

- **Ang B ay para sa presyon ng dugo.** Kung mas mataas ang presyon ng iyong dugo, mas magiging mahirap ang paggana ng iyong puso. Kunin ang presyon ng iyong dugo sa bawat pagbisita sa duktur.

**Bilang na dapat hangarin:** mas mababa sa 130/80 mmHg

<b>Petsa</b>							
<b>Resulta</b>							

# Maging Matalino sa Pangangalaga ng Iyong Puso: Kontrolin ang mga ABC ng Diyabetis

(continued)

- **Ang C ay para sa kolesterol.** Panatilihin ang isang normal na antas ng kolesterol. Ang “masamang” kolesterol, o LDL, ay namumuo at binabarahan ang iyong mga ugat. Kunin ang iyong kolesterol nang hindi bababa sa isa sa isang taon.

**Bilang na dapat hangarin:** mas mababa sa 100 mg/dL

<b>Petsa</b>							
<b>Resulta</b>							

## Tiyakin na tanungin ang iyong duktur:

- Ano ang mga numero ng aking ABC?
- Ano ang dapat na mga puntiryang numero ng aking ABC?
- Anong mga pagkilos and dapat kong gawin upang maabot ang mga puntiryang numero ng aking ABC?

**Isulat ang mga pagbabago na gagawin mo para sa linggong ito upang makontrol ang iyong asukal sa dugo, presyon ng dugo, o kolesterol.**

---

(Petsa)

---

(Petsa)

# Read the Nutrition Facts Label for Sugar!



Nutrition Facts labels tell you what you need to know about choosing foods that are lower in calories and sugar. Here is a Nutrition Facts label for mango nectar. The label provides lots of useful information.

## Amount Per Serving

The nutrient amounts provided on the label are for one serving. If you have more than one serving, you will get more calories and other nutrients. For example, if you drink two servings (2 cups) of mango nectar, you will take in 460 calories and 100 grams of sugar.

## Calories and Sugar

Here are the amounts of calories and sugar in one serving.

## Mango Nectar

Nutrition Facts	
Serving Size 1	
Servings Per Container 1	
Amount Per Serving	
<b>Calories</b> 230	Calories from Fat 0
% Daily Value*	
<b>Total Fat</b> 0g	0%
Saturated Fat 0g	0%
Trans Fat 0g	
<b>Cholesterol</b> 0mg	0%
<b>Sodium</b> 15mg	1%
<b>Total Carbohydrate</b> 56g	19%
Dietary Fiber 2g	8%
<b>Sugars</b> 50g	
<b>Protein</b> 0g	
Vitamin A 35%	Vitamin C 100%
Calcium 4%	Iron 4%

## Serving Size and Number of Servings

The serving size is 1 cup. There is one serving in this container.

## Percent Daily Value

The Percent Daily Value helps you compare nutrient amounts in products. There is no Percent Daily Value for calories or sugar. Choose foods with the lowest amount of calories and sugar.

## The Choice Is Yours—Compare!

### Which one would you choose?

The unsweetened iced tea has fewer calories and no sugar. That makes the iced tea a better choice! Read Nutrition Facts labels, and choose products to keep your heart strong.

<b>Calories</b> 230	Calories from Fat 0
% Daily Value*	
<b>Total Fat</b> 0g	0%
Saturated Fat 0g	0%
Trans Fat 0g	
<b>Cholesterol</b> 0mg	0%
<b>Sodium</b> 15mg	1%
<b>Sugars</b> 50g	

<b>Calories</b> 5	Calories from Fat 0
% Daily Value*	
<b>Total Fat</b> 0g	0%
Saturated Fat 0g	0%
Trans Fat 0g	
<b>Cholesterol</b> 0mg	0%
<b>Sodium</b> 0mg	0%
<b>Sugar</b> 0g	

## Mango Nectar

One cup of mango nectar has 230 calories and 50 grams of sugar.

## Unsweetened Iced Tea

One cup of unsweetened iced tea has 5 calories and no sugar. You can learn a lot from a Nutrition Facts label.

\*Percent Daily Values are based on a 2,000-calorie diet. Your Daily Values may be higher or lower depending on your calorie needs.

# Basahin ang Label ng Mga Katotohanan sa Nutrisyon para sa Asukal!



Ang mga *label* ng Mga Katotohanan sa Nutrisyon ay nagsasabi sa iyo kung ano ang kinakailangan mong malaman tungkol sa pagpili ng mga pagkain na mababa sa mga calorie at asukal. Narito ang isang *label* ng Mga Katotohanan sa Nutrisyon para sa *mango juice*. Ang *label* ay nagbibigay ng mga kapakipakinabang na impormasyon.

## Mango nectar

### Dami sa bawat Takal

Ang dami ng nutrisyon ay ipinakita sa label na para sa isang takal. Kung mayroon kang higit sa isang takal, ikaw ay makakakuha ng mas maraming mga calorie at ibang mga nutrisyon. Halimbawa, kung iinom ka ng dalawang takal (2 tasa) ng *mango nectar*, makakakuha ka ng 230 na calorie at 50 na gramo ng asukal.

### Mga Calorie at Asukal

Narito ang mga dami ng mga calorie at asukal sa isang takal.

Nutrition Facts	
Serving Size 1	
Servings Per Container 1	
Amount Per Serving	
Calories 230	Calories from Fat 0
% Daily Value*	
Total Fat 0g	0%
Saturated Fat 0g	0%
Trans Fat 0g	
Cholesterol 0mg	0%
Sodium 15mg	1%
Total Carbohydrate 56g	19%
Dietary Fiber 2g	8%
Sugars 50g	
Protein 0g	
Vitamin A 35%	Vitamin C 100%
Calcium 4%	Iron 4%

### Laki ng Takal at Bilang ng Mga Takal

Ang laki ng takal ay 1 tasa. Mayroon itong walong mga takal sa lalagyan na ito.

### Porsyento ng Pang-araw-araw na Halaga

Ang Porsyento ng Pang-araw-araw na Halaga ay nakakatulong sa iyo sa paghambing ng mga dami ng nutrisyon sa mga produkto. Walang Porsyento ng Pang-araw-araw na Halaga para sa mga calorie o asukal. Pumili ng mga pagkain na mababa ang dami ng mga calorie at asukal.

# Basahin ang *Label* ng Mga Katotohanan sa Nutrisyon para sa Asukal! *(continued)*

## Ikaw ang Bahalang Mamili—Ihambing!

### Ano ang iyong pipiliin?

Ang *unsweetened iced tea* ay kaunti ang mga calorie at walang asukal. Na gagawing mas mahusay na pagpipilian ang *iced tea*! Basahin ang mga label ngn Mga Katotohanan sa Nutrisyon at pumili ng mga produkto upang mapanatili na malakas ang iyong puso.

### *Mango nectar*

Isang tasa ng mango nectar ay mayroong 230 na mga calorie at 50 na mga gramo ng asukal.

Calories 150		Calories from Fat 0
% Daily Value*		
Total Fat	0g	0%
Saturated Fat	0g	0%
Trans Fat	0g	
Cholesterol	0mg	0%
Sodium	15mg	1%
Potassium	170mg	5%
Total Carbohydrates	37mg	12%
Dietary Fiber	0g	0%
Sugars	32g	

### *Unsweetened Iced Tea*

Isang tasa ng *unsweetened iced tea* ay mayroong 5 na mga calorie at walang asukal. Maaaring marami kang matutunan mula sa isang *label* ng Mga Katotohanan sa Nutrisyon.

Calories 5		Calories from Fat 0
% Daily Value*		
Total Fat	0g	0%
Saturated Fat	0g	0%
Trans Fat	0g	
Cholesterol	0mg	0%
Sodium	0mg	0%
Potassium	0	0%
Total Carbohydrates	0mg	0%
Dietary Fiber	0g	
Sugars	0g	

# Mila's Food Choices



Mila has offered to go grocery shopping for her mother, Lola Idad, who is home sick with the flu. Lola also has diabetes.

Mila wants to buy foods that are lower in calories and sugar to help her mother. Look at the Nutrition Facts labels. Help Mila select foods that are lower in sugar.

Which foods should Mila buy? Write the number of your choice for each pair. Then write the number of grams of sugar saved by this choice.

## 1 – Pan de Sal (Filipino Roll)

Nutrition Facts	
Serving Size 1 roll (25g)	
Servings Per Container 16	
Amount Per Serving	
<b>Calories</b> 140	Calories from Fat 14
% Daily Value*	
<b>Total Fat</b> 1.5g	<b>2%</b>
Saturated Fat 0g	<b>0%</b>
Trans Fat 0g	
<b>Cholesterol</b> 0mg	<b>0%</b>
<b>Sodium</b> 330mg	<b>14%</b>
<b>Total Carbohydrate</b> 38g	<b>13%</b>
Dietary Fiber 2g	<b>4%</b>
Sugars 1g	
<b>Protein</b> 6g	
Vitamin A 10%	Vitamin C 0%
Calcium 6%	Iron 10%

Lower  
sugar  
choice

Grams  
of sugar  
saved

## 2 – Doughnut

Nutrition Facts	
Serving Size 1 doughnut (54g)	
Servings Per Container 5	
Amount Per Serving	
<b>Calories</b> 290	Calories from Fat 170
% Daily Value*	
<b>Total Fat</b> 19g	<b>29%</b>
Saturated Fat 6g	<b>30%</b>
Trans Fat 2g	
<b>Cholesterol</b> 10mg	<b>3%</b>
<b>Sodium</b> 240mg	<b>10%</b>
<b>Total Carbohydrate</b> 27g	<b>9%</b>
Dietary Fiber 1g	<b>0%</b>
Sugars 15g	
<b>Protein</b> 3g	
Vitamin A 0%	Vitamin C 0%
Calcium 2%	Iron 8%

## 3 – Cooked Oatmeal

Nutrition Facts	
Serving Size ½ cup	
Servings Per Container 13	
Amount Per Serving	
<b>Calories</b> 130	Calories from Fat 20
% Daily Value*	
<b>Total Fat</b> 2g	<b>3%</b>
Saturated Fat 0g	<b>0%</b>
Trans Fat 0g	
<b>Cholesterol</b> 0mg	<b>0%</b>
<b>Sodium</b> 0mg	<b>0%</b>
<b>Total Carbohydrate</b> 22g	<b>7%</b>
Dietary Fiber 4g	<b>16%</b>
Sugars 0g	
<b>Protein</b> 5g	
Vitamin A 0%	Vitamin C 0%
Calcium 13%	Iron 10%

Lower  
sugar  
choice

Grams  
of sugar  
saved

## 4 – Bibingka (Sweet Rice Cake)

Nutrition Facts	
Serving Size 1 popsicle (273g)	
Servings Per Container 4	
Amount Per Serving	
<b>Calories</b> 890	Calories from Fat 460
% Daily Value*	
<b>Total Fat</b> 51g	<b>78%</b>
Saturated Fat 37g	<b>185%</b>
Trans Fat 0g	
<b>Cholesterol</b> 219mg	<b>73%</b>
<b>Sodium</b> 1940mg	<b>81%</b>
<b>Total Carbohydrate</b> 99g	<b>33%</b>
Dietary Fiber 6g	<b>24%</b>
Sugars 44g	
<b>Protein</b> 15g	
Vitamin A 17%	Vitamin C 3%
Calcium 105%	Iron 21%

\* Percent Daily Values are based on a 2,000-calorie diet. Your Daily Values may be higher or lower depending on your calorie needs.

# Mila's Food Choices *(continued)*

## 5 – Gelatin

Nutrition Facts	
Serving Size ¼ cup	
Servings Per Container 8	
Amount Per Serving	
Calories 80	Calories from Fat 0
% Daily Value*	
<b>Total Fat</b> 0g	<b>0%</b>
Saturated Fat 0g	<b>0%</b>
Trans Fat 0g	
<b>Cholesterol</b> 0mg	<b>0%</b>
<b>Sodium</b> 100mg	<b>4%</b>
<b>Total Carbohydrate</b> 19g	<b>6%</b>
Dietary Fiber 0g	<b>0%</b>
Sugars 19g	
<b>Protein</b> 2g	
Vitamin A 0%	Vitamin C 0%
Calcium 0%	Iron 0%

Lower  
sugar  
choice

Grams  
of sugar  
saved

## 6 – Sugar-Free Gelatin

Nutrition Facts	
Serving Size ¼ cup	
Servings Per Container 8	
Amount Per Serving	
Calories 10	Calories from Fat 0
% Daily Value*	
<b>Total Fat</b> 0g	<b>0%</b>
Saturated Fat 0g	<b>0%</b>
Trans Fat 0g	
<b>Cholesterol</b> 0mg	<b>0%</b>
<b>Sodium</b> 55mg	<b>2%</b>
<b>Total Carbohydrate</b> 0g	<b>0%</b>
Dietary Fiber 0g	<b>0%</b>
Sugars 0g	
<b>Protein</b> 1g	
Vitamin A 0%	Vitamin C 0%
Calcium 0%	Iron 0%

## 7 – Fat-Free, No-Sugar-Added Ice Cream

Nutrition Facts	
Serving Size ½ cup (66g)	
Servings Per Container 16	
Amount Per Serving	
Calories 80	Calories from Fat 0
% Daily Value*	
<b>Total Fat</b> 0g	<b>0%</b>
Saturated Fat 0g	<b>0%</b>
Trans Fat 0g	
<b>Cholesterol</b> 0mg	<b>0%</b>
<b>Sodium</b> 50mg	<b>2%</b>
<b>Total Carbohydrate</b> 19g	<b>6%</b>
Dietary Fiber 5g	<b>20%</b>
Sugars 4g	
<b>Protein</b> 3g	
Vitamin A 6%	Vitamin C 0%
Calcium 8%	Iron 0%

Lower  
sugar  
choice

Grams  
of sugar  
saved

## 8 – Chocolate Ice Cream

Nutrition Facts	
Serving Size ½ cup (66g)	
Servings Per Container 16	
Amount Per Serving	
Calories 170	Calories from Fat 80
% Daily Value*	
<b>Total Fat</b> 9g	<b>14%</b>
Saturated Fat 6g	<b>30%</b>
Trans Fat 0g	
<b>Cholesterol</b> 20mg	<b>7%</b>
<b>Sodium</b> 40mg	<b>2%</b>
<b>Total Carbohydrate</b> 21g	<b>7%</b>
Dietary Fiber 1g	<b>4%</b>
Sugars 17g	
<b>Protein</b> 2g	
Vitamin A 4%	Vitamin C 0%
Calcium 6%	Iron 4%

\*Percent Daily Values are based on a 2,000-calorie diet. Your Daily Values may be higher or lower depending on your calorie needs.



# Mila's Food Choices *(continued)*

## 9 – Water

<b>Nutrition Facts</b>	
Serving Size 1 bottle (16 oz)	
Servings Per Container 1	
Amount Per Serving	
<b>Calories</b> 0	Calories from Fat 0
% Daily Value*	
<b>Total Fat</b> 0g	<b>0%</b>
Saturated Fat 0g	<b>0%</b>
Trans Fat 0g	
<b>Cholesterol</b> 0mg	<b>0%</b>
<b>Sodium</b> 0mg	<b>0%</b>
<b>Total Carbohydrate</b> 0g	<b>0%</b>
Dietary Fiber 0g	<b>0%</b>
Sugars 0g	
<b>Protein</b> 0g	
Vitamin A 0%	• Vitamin C 0%
Calcium 0%	• Iron 0%

Lower  
sugar  
choice

Grams  
of sugar  
saved

## 10 – Regular Soda







<b>Nutrition Facts</b>	
Serving Size 1 can (12 fl oz)	
Servings Per Container 1	
Amount Per Serving	
<b>Calories</b> 140	Calories from Fat 0
% Daily Value*	
<b>Total Fat</b> 0g	<b>0%</b>
Saturated Fat 0g	<b>0%</b>
Trans Fat 0g	
<b>Cholesterol</b> 0mg	<b>0%</b>
<b>Sodium</b> 50mg	<b>2%</b>
<b>Total Carbohydrate</b> 39g	<b>13%</b>
Dietary Fiber 0g	<b>0%</b>
Sugars 39g	
<b>Protein</b> 1g	
Vitamin A 0%	• Vitamin C 0%
Calcium 0%	• Iron 0%

\*Percent Daily Values are based on a 2,000-calorie diet. Your Daily Values may be higher or lower depending on your calorie needs.

# Think Before You Drink: Hidden Sugar in Common Beverages

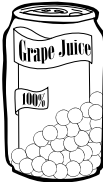
Try to guess the amount of sugar (in teaspoons) that is found in each drink.

Write your answers on the “My Guess” line.

Drink (12 ounces)	Teaspoons of Sugar	
	My Guess	True Amount
<b>Powdered drink with sugar</b> 	_____	_____
<b>Diet soda</b> 	_____	_____
<b>Grape juice</b> 	_____	_____
<b>Regular soda</b> 	_____	_____
<b>Mango nectar</b> 	_____	_____
<b>Energy Drink (8 ounces)</b> 	_____	_____

# How Much Sugar and How Many Calories Are in Your Favorite Drink?



<b>Drink (12-ounce serving)</b>	<b>Grams of Sugar</b>	<b>Approximate Number of Teaspoons of Sugar*</b>	<b>Calories</b>
Bottled Water	0 grams	0 teaspoons	0
Ginger Ale	25 grams	6¼ teaspoons	90
Diet Ginger Ale	0 grams	0 teaspoons	0
Cola	41 grams	10¼ teaspoons	150
Diet Cola	0 grams	0 teaspoons	0
Root Beer	46 grams	11½ teaspoons	170
Orange Soda	52 grams	13 teaspoons	210
Powdered Drink With Sugar	36 grams	9 teaspoons	145
Sugar-Free Powdered Drink	0 grams	0 teaspoons	0
Grape Juice	32 grams	8 teaspoons	150
Orange Juice	20 grams	5 teaspoons	105
Mango Nectar	50 grams	12½ teaspoons	230
Guava Nectar	48 grams	12 teaspoons	240
Fruit Punch	46 grams	11½ teaspoons	195
Iced Tea	33 grams	8¼ teaspoons	120
Sports Drink	8½ grams	2 teaspoons	75
Energy Drink (8 ounces)	25 grams	6¼ teaspoons	190
Chocolate Drink (6.5 ounces)	22 grams	5½ teaspoons	110

\* 1 teaspoon = 4 grams of sugar

# *Pesang Isda* (Fish Simmered With Ginger and Tomatoes) Recipe

4 cups	water
1 cup	ripe tomatoes, chopped
¼ cup	fresh ginger, thinly sliced (about 2 inches long)
1 cup	white or yellow onions, thinly sliced (1 medium onion)
2 pounds	fleshy fish (cod fillet, halibut steak, or trout)
2 cups	<i>pechay</i> (bok choy) stems and leaves, cut up separately
½ teaspoon	salt
½ teaspoon	ground pepper
1 cup (about 1 large bunch)	green onions, cut 2 to 3 inches (6 medium)

1. In a 4-quart saucepan, simmer sliced ginger, tomatoes, and onions in 4 cups of water over medium heat until onions are tender (about 7 to 8 minutes).
2. Reduce heat to low, add fish, and poach gently until almost done (about 3 to 4 minutes).
3. Add *pechay* stems, salt, and ground pepper. Cook for 1 minute; then add *pechay* leaves and green onions. Cook another 30 seconds.
4. Serve immediately.

## Quick Facts

This main dish is heart healthy because:

1. It is made with fish and vegetables.
2. The fish is simmered in water, not fried.
3. No fat is added to the dish.
4. Flavoring is added with herbs and spices instead of sauces that are high in sodium.

<b>Yield:</b>	<b>Serving size:</b>
<b>6 servings</b>	<b>3 ounces lean fish and ½ cup vegetables:</b>
Calories	160 kcal
Total Fat	2 g
Saturated Fat	0.5 g
Cholesterol	80 mg
Sodium	340 mg
Total Fiber	2 g
Protein	30 g
Carbohydrates	6 g
Potassium	630 mg

Source: Filipino American Food Practices, Customs, and Holidays, American Dietetic Association, 1994.

# Munggo Guisado

## (Sauteed Mung Beans) Recipe

1 tablespoon	corn oil
2 cloves	fresh garlic, crushed (or 1 tablespoon, minced)
1 cup	white onions, chopped (1 medium)
1 cup	raw tomatoes, chopped (2 small)
1 cup	raw lean pork, thinly sliced (4 ounces)
1 cup	raw shrimp, peeled (4 ounces)
1 cup	leaf spinach, frozen (about $\frac{2}{3}$ of a 10-ounce package)
3½ cups	precooked mung beans (from 1¾ cups dry beans)*
4 cups	water
1 teaspoon	salt
1 teaspoon	ground pepper

\* To cook dry, uncooked mung beans: Wash and boil the uncooked mung beans in a large saucepan, using 6 cups of water. Cook until tender, about 1½ to 2 hours. Drain.

### Quick Facts

This side dish is heart healthy because:

1. It is made with vegetables, seafood (shrimp), and lean meat.
2. A small amount of corn oil is added.
3. The pork is simmered slowly in moist heat.

1. In a skillet, heat oil, and saute crushed garlic until lightly brown.
2. Add onion and tomatoes. Saute until skin begins to curl.
3. Add pork, and saute until lightly brown.
4. Add water, and simmer pork for about 15 minutes.
5. Add the sauteed mix to mung beans, and continue to simmer 15 minutes.
6. Season with salt and ground pepper.
7. Add peeled shrimp.
8. Add frozen leaf spinach, and cook 4 minutes until done.

Yield:	Serving size:
<b>8 servings</b>	<b>1 cup:</b>
Calories	160 kcal
Total Fat	3.5 g
Saturated Fat	1 g
Cholesterol	35 mg
Sodium	350 mg
Total Fiber	8 g
Protein	13 g
Carbohydrates	19 g
Potassium	370 mg

Source: Filipino American Food Practices, Customs, and Holidays, American Dietetic Association, 1994.

# Lola's Life Lessons: Session 7

---

One of my favorite proverbs is:

*“Sa taong walang takot, walang mataas na bakod.”*

Translation: “To a fearless person, no fence is too high.”

With courage, there is hope. Although Rose has prediabetes, she can do something to decrease her chance of getting diabetes: lose weight, become physically active, and eat heart healthy. She is lucky—still young and strong! Your Lolo (grandfather) had diabetes, and controlling his blood glucose was not a priority for him. He had a chance to be fearless, but he loved food too much.

It takes a courageous person to admit what is not working and try to change it. I know how hard it can be to change old habits. But look at Lola. I am an “old timer,” and I was fearless. I did not give up! You must be fearless to tackle things that are high priority, even if it seems impossible. With each day, my family is learning that hope will not fail you. Remember, no fence is too high!

## **A Time To Reflect...**

What changes have you made in your life to become heart healthy? What new changes can you make to continue on the journey to heart health?

(Use this space to write down your thoughts for this week's session.)

# Pledge for Life! Session 7

---

Take the pledge for life with Lola Idad's family. Try to do one or more of these activities by yourself or share them with others.

- Know the symptoms of diabetes.
- Talk to your doctor about your risk factors for diabetes and about your ABC numbers.
- Find out if you or other family members have prediabetes or diabetes.
- Eat smaller portions of food.
- Do physical activity every day.
- Lose weight if you are overweight or obese.
- Maintain your weight if it is in the healthy range.
- Keep a food and physical activity diary.
- Make reasonable goals for yourself and reward yourself with non-food items, like watching a movie.
- Other \_\_\_\_\_

# Welcome Heart Healthy Eating Into Your Home

---

## Objectives

By the end of this session, group members will learn:

- How to plan and prepare traditional Filipino meals in a heart healthy way
- How to choose foods for a heart healthy eating plan

---

## Materials and Supplies

To conduct this session, you will need:

- “Healthy Heart, Healthy Family” manual and picture cards
- Set of measuring cups (1 cup, ½ cup, ¼ cup)
- Blackboard and chalk or several large pieces of paper, a marker, and tape
- Enough pairs of scissors and glue sticks for group members to use during the activity

---

## Handouts

Give group members these handouts during this session:

- *(Optional)* “Serving Sizes” (from Session 6, page 224)
- “Heart Healthy Eating Plan” (pages 307–309)



- “Add Color and Flavor to Your Menu” (pages 310–313)
  - “Say Yes to Fruits and Vegetables” (pages 314–315)
  - *(Optional)* “Heart Healthy Scenarios With the de la Cruz Family” (pages 316–318)
  - “*Ampalaya* (Bitter Melon) With Pork Recipe” (page 319)
  - “Cooking With Children” (pages 320–321)
  - “Cantaloupe Crush Recipe for Children” (page 322)
  - “Lola’s Life Lessons: Session 8” (page 323)
  - “Pledge for Life! Session 8” (page 324)
- 

## **Session Outline**

### **Introducing the Session**

1. Welcome
2. Review of Last Week’s Session
3. About This Session

### **Conducting the Session**

1. Eat a Variety of Heart Healthy Foods
2. The Traditional Filipino Diet
3. A Heart Healthy Eating Plan for Filipino Families
4. How To Choose Heart Healthy Foods

5. *(Optional)* Heart Healthy Scenarios With the de la Cruz Family
6. *Ampalaya* (Bitter Melon) With Pork Recipe
7. Cooking With Children

## **Review of Today's Key Points**

## **Lola's Life Lessons: A Time To Reflect**

## **Pledge for Life!**

## **Closing**

# Introducing the Session

---

## **1. Welcome**

- Welcome group members to the session.

## **2. Review of Last Week's Session**

- **Say:**

At the last session, we talked about what you need to know about diabetes.

- **Ask** these questions, and **review** the answers with group members.

### **What is diabetes?**

- Diabetes results when the body does not make enough insulin or cannot make it well, causing glucose (sugar) to build up in the blood. As a result, the body does not function well.

## **What are risk factors for diabetes?**

- Overweight
- Family members with diabetes
- Not having a physically active lifestyle
- Being Latino, African American, American Indian, Asian American, or Native Hawaiian or other Pacific Islander
- History of gestational diabetes or having given birth to at least one baby weighing 9 pounds (4.1 kg) or more
- High blood pressure
- Cholesterol levels are not normal: HDL cholesterol is low, or triglycerides are high

## **What are the ABCs of diabetes control?**

- A is for the A1C test. This simple lab test reflects a person's average blood glucose level over the previous 3 months. The A1C number to aim for is below seven.
- B is for blood pressure. The higher your blood pressure, the harder your heart has to work. High blood pressure increases your risk for a heart attack, stroke, and damage to your kidneys and eyes. Your blood pressure should be below 130/80 mmHg (millimeters of mercury).
- C is for cholesterol. Keep cholesterol at normal levels. Bad cholesterol, or LDL, can build up and clog your arteries. It can lead to a heart attack or stroke. People with type 2 diabetes need to keep their LDL cholesterol below 100 mg/dL (milligrams per deciliter).

## **How does diabetes affect your body?**

- Diabetes can cause damage to the heart, brain, kidneys, and eyes. It can cause nerve damage, which reduces feeling in your feet. Diabetes can also affect blood flow in your legs and feet. This can lead to sores that don't heal and amputation.

■ **Say:**

At the end of the last session, you made a pledge to do something to help you prevent or control diabetes. What problems did you have? How did you deal with any problems?



**Note:** Allow 2 minutes for each group member to respond.

### **3. About This Session**

■ **Say:**

In this session, you will learn that what you choose to eat can make a difference in your heart health. With the help of Lola’s family, you will learn how to:

- Choose a variety of foods for heart health.
- Identify serving sizes and the number of recommended servings for each food group.

■ **Say:**

- Lola Idad encourages her family to make these heart healthy changes together. She often says, “*Ang mabigat ay gumagaan, kung pinagtutulungan.*” “A heavy burden is lightened if everyone participates in carrying it.”
- The de la Cruz family members support one another as they learn how to welcome heart healthy eating into their home.

## Conducting the Session

---

### **1. Eat a Variety of Heart Healthy Foods**

■ **Ask:**

Why is it important to eat a variety of heart healthy foods?



**Note:** Allow about 5 minutes for group members to respond. Write their answers on the blackboard or on a large piece of paper taped to the wall.

■ **Add** the answers below if group members do not say them.

- Eating a variety of foods that are lower in saturated fat, *trans* fat, cholesterol, salt and sodium, added sugar, and calories can help you have a healthy heart.
- One food cannot provide all the nutrients your body needs in the amounts that it needs them.

### More Information

**Nutrients in the foods we eat include:**

Carbohydrates

Protein

Fats

Fiber

Vitamins

Minerals

## 2. The Traditional Filipino Diet



**Note:** This session will help group members think about the foods they eat. Some of their favorite traditional Filipino foods are very nutritious. Other dishes can be prepared in more heart healthy ways.

■ **Ask:**

What are some traditional Filipino foods?



**Note:** Allow about 5 minutes for group members to respond. Write their answers on the blackboard or on a large piece of paper taped to the wall.

■ **Say:**

Many traditional Filipino foods are heart healthy for you and your family. These include:

- Steamed rice, white or brown
- Beans, such as mung beans, black beans, and string beans
- Fruits, such as mango

- Vegetables, such as squash and carrots
- Fish and seafood, such as milkfish (*bangus*), grouper (*lapu-lapu*), shrimp (*hipon*), mackerel (*galunggong*), mussels (*tahong*), clams (*tulya*), large and small crabs (*alimango and alimasag*), and squid (*pusit*)

■ **Say:**

Rice is a very important part of the Filipino diet. Rice and fish, together, are a good source of protein. But we need to be careful about the way we prepare them.

■ **Say:**

Some Filipinos have adopted cooking and eating habits that can lead to health problems such as heart disease. What are some examples of these habits?



**Note:** Allow about 3 minutes for group members to answer. Add these habits if they are not mentioned:

- Cooking foods with too much saturated fat, such as lard and shortening, as well as coconut oil and palm oil
- Eating fried foods often, such as *longanisa* (native sausage), fried *lumpia* (egg roll), *sinangag* (garlic fried rice), and fried meat and vegetables
- Eating foods higher in saturated fat, such as fatty meats, canned and processed meat, high-fat cheeses and creams, whole milk, banana chips, and other chips
- Eating foods that are higher in calories, such as *bibingka* or *ginataan* (desserts that contain coconut milk), candies, and chocolate
- Drinking high-calorie beverages such as regular soft drinks
- Eating fewer fruits and vegetables
- Eating meats high in saturated fat instead of lean meats

- Eating foods high in *trans* fat such as cookies, crackers, doughnuts, baked goods, and french fries
- Eating sauces high in sodium, such as soy sauce, *bagoong* (salted fish paste) and *patis* (fish sauce).

### 3. A Heart Healthy Eating Plan for Filipino Families

■ **Say:**

We can take steps to improve the way we eat and still enjoy our traditional foods. The first step is to learn which foods we should eat more often. The second step is to learn the amounts of these foods that we should eat each day.

■ **Show picture card 8.1.** (Keep it in view throughout this activity.)

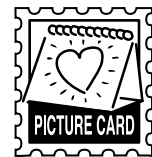

■ **Say:**

This heart healthy eating plan shows us the types of foods we can choose for better health.

■ **Give** group members the “Heart Healthy Eating Plan” handout (pages 307–309).



■ **Say:**

The food choices you make each day affect your health. We will talk about ways to choose healthy foods from the food groups in the heart healthy eating plan.

#### Grains (6 to 8 servings a day)

■ **Say:**

- Make at least half of your grains whole grains. Eat at least three servings of whole-grain cereals, breads, rice, or noodles (pasta) every day. Remember, one ounce of grains is a serving. In general, 1 ounce of grains is one slice of bread, about 1 cup of ready-to-eat cereal, or ½ cup of steamed rice, cooked noodles, or cooked cereal.

- Look at the Nutrition Facts label, and choose grain products that have whole grains as the first ingredient. Some examples of whole-grain ingredients are whole wheat, whole oats, oatmeal, and whole rye.
- For a change, try brown rice or whole-wheat noodles instead of white rice or noodles.
- Snack on ready-to-eat, whole-grain cereal such as toasted oat cereal. Also try popcorn with little or no salt or butter as a snack.

## **Vegetables (4 to 5 servings a day)**

### **■ Say:**

- Eat more dark green vegetables, such as bok choy (*pechay*), broccoli, spinach, and other dark leafy greens.
- Eat more orange vegetables, such as carrots and sweet potatoes (*camote*).
- Stock up on frozen vegetables for quick and easy cooking in the microwave.
- Buy fresh vegetables in season. They cost less and are likely to be at their peak flavor.
- Plan some meals around a vegetable main dish, such as vegetable stirfry or soup.
- Choose no-salt-added canned vegetables.

## **Fruits (4 to 5 servings a day)**

### **■ Say:**

- Choose fresh, frozen, canned, or dried fruit.
- Limit fruit juices, because they contain a lot of calories and sugar. Try choosing whole fruit instead of juice most of the time.
- Keep a bowl of whole fruit on the table, on the counter, or in the refrigerator.



## **Fat-free or low-fat milk and milk products (2 to 3 servings a day)**

### **■ Say:**

- Get your calcium-rich foods.
- Choose fat-free or low-fat milk, yogurt, and other milk products.
- If you usually use whole milk, switch gradually to fat-free milk. Try reduced-fat (2%) milk, then low-fat (1%) milk, and then fat-free milk.
- Have fat-free or low-fat yogurt for a snack.
- If you are lactose intolerant, try lactose-free products, such as yogurt, cheese, or lactose-free milk.

## **Lean meats, poultry, and fish (2 or fewer 3-ounce servings a day)**

### **■ Say:**

- Choose low-fat or lean meats and poultry. Select meat cuts that are low in fat and ground beef that is extra lean.
- Eat a variety of foods with protein. Choose more fish, seafood, and tofu.
- Choose lean chicken, roast beef, or ham, instead of fatty lunch meats, such as regular bologna or salami.
- Bake, steam, broil, or grill meat.

## **Nuts, seeds, and legumes (4 to 5 servings a week)**

### **■ Say:**

- Choose cooked and dry beans, nuts, seeds, and peas for rich sources of protein and fiber.

## **Fats and oils**

### ■ Say:

- Get most of your fat from food sources, such as fish and seafood, nuts, and vegetable oils.
- Limit solid fats and oils such as butter, stick margarine, shortening, lard, coconut oil, and palm oil, as well as foods that contain these fats.

## **Sweets and added sugars (5 or fewer servings a week)**

### ■ Say:

- Choose foods and beverages that are low in calories and added sugar. Use the Nutrition Facts label to compare the calorie and sugar content of foods and beverages.
- Choose water, fat-free milk, or other unsweetened beverages most often.
- Select unsweetened cereal and add a noncalorie sweetener or fruit.

### ■ Ask these questions, and **hold up** the correct measuring cup for each answer.

#### **What is one serving of a cooked vegetable?**

- ½ cup

#### **How much milk or yogurt is considered one serving?**

- 1 cup

#### **How much cheese is considered one serving?**

- 1.5 to 2 ounces

#### **Can you give an example of a 1-ounce serving from the grains group?**

- 1-ounce servings from the grains group include:
  - ½ cup of steamed rice or noodles
  - One slice of bread
  - About 1 cup of ready-to-eat cereal or ½ cup of cooked cereal, such as oatmeal

## What counts as one serving of fruit?

- 1 medium apple, banana, or orange
- ½ cup of raw or canned fruit or 100% fruit juice
- ¼ cup dried fruit

## Say Yes to Fruits and Vegetables Activity



- **Divide** participants into small groups of three to four people.
- **Give** every small group the “Add Color and Flavor to Your Menu” handout (pages 310–313) and the “Say Yes to Fruits and Vegetables” handout (pages 314–315).



- **Give** each group a pair of scissors and a glue stick, so they can cut out and paste the pictures.
- **Say:**

Now let’s do the “Say Yes to Fruits and Vegetables” activity to learn how to add fruits and vegetables to your meals.

- **Say:**

For this activity, cut out the pictures of fruits and vegetables on the handout that I gave you. Cut out the fruits and vegetables that you want to add to your breakfast, lunch, dinner, and snack. Then paste your fruit and vegetable choices in the correct spaces on each menu.



**Note:** Allow 10 minutes for group members to complete their meals.

- **Ask** each group member to say what fruits and vegetables they added to their meals.
- Then, **ask** the rest of the group members if they have any other suggestions.

■ **Say:**

Great job! Now you know how easy and fun it can be to add fruits and vegetables to your meals.

## 4. How To Choose Heart Healthy Foods

■ **Say:**

We are going to do another group activity. During this activity, we will learn how to make better food choices.



**Note:** Write Rose’s breakfast on the blackboard or on a large piece of paper taped to the wall. Fill in the **Rose’s Breakfast** and **Portion Size** columns. Leave the **Food Group** and **Better Choices** columns blank. *(Optional)* Repeat the game with the lunch and dinner meals.

<b>BREAKFAST</b>			
<b>Rose’s Breakfast</b>	<b>Food Group</b> <i>(Leave blank for activity)</i>	<b>Portion Size</b>	<b>Better Choices</b> <i>(Leave blank for activity)</i>
Fried egg	Meats and beans	1 egg	Boiled or poached egg, ½ cup egg substitute, or 2 egg whites. Scramble egg with vegetable oil spray.
Bacon	Meats and beans	3 strips	Leftover grilled chicken, 3 ounces; or Canadian bacon, 2 strips
Fried rice (with egg, green onions, garlic, butter, sausage)	Grains, meats and beans, vegetables, fats and oils	½ cup	Plain, steamed white or brown rice, ½ cup
Mango nectar drink	Fruit	½ cup	Pineapple juice or fresh mango, ½ cup
Coffee with condensed milk	Milk	1 cup coffee 1 tablespoon of milk	Coffee with fat-free milk (or 1 tablespoon of evaporated fat-free milk)

■ **Ask:**

To which group does each food belong? What changes would make Rose's breakfast more heart healthy?

■ **Write** the suggestions beside the foods they are replacing on the blackboard or on a large piece of paper taped to the wall. **Fill in** the correct answers for any items not mentioned by group members.

■ *(Optional meals: lunch and dinner)*

<b>LUNCH</b>			
<b>Rose's Lunch</b>	<b>Food Group</b> <i>(Leave blank for activity)</i>	<b>Portion Size</b>	<b>Better Choices</b> <i>(leave blank for activity)</i>
Large bacon cheeseburger with mayonnaise	Meats and beans, grains, milk, vegetables, fats and oils	1 large cheeseburger	Leftover shrimp; steamed vegetables, ½ cup
Super-size french fries	Vegetables, fats and oils	1 large (6 ounces) serving of fries	Steamed white or brown rice, ½ cup
Apple pie	Fruits, grains, fats and oils, sweets and added sugars	1 large (2.7 ounce) serving	Fresh papaya, ½ slice
Vanilla milkshake	Milk, sweets and added sugars	1 milkshake, 32 ounces	Fat-free or low-fat milk, or lactose-free milk

## DINNER

Rose's Dinner	Food Group <i>(Leave blank for activity)</i>	Portion Size	Better Choices <i>(leave blank for activity)</i>
Fried <i>lumpia</i>	Meats and beans, fats and oils	3 fried <i>lumpia</i>	Fresh <i>lumpia</i> (1)
Fried chicken with fried rice	Meats and beans, grains, fats and oils	2 pieces of chicken, 1½ cups fried rice	<i>Pancit</i> with shrimp and lean pork (1 ounce cooked)
Large soft drink	Sweets and added sugars	1 cup	Water, diet soft drink, soy milk (1 cup), or fruit juice (½ cup)
Flan	Fats and oils, milk, sweets and added sugars, meat and beans	1 slice	Fresh fruit cup (½ cup) or low-fat frozen yogurt

■ **Ask:**

What are some ways to eat less saturated fat, *trans* fat, cholesterol, sodium, and calories?

■ **Add** the following answers if they are not mentioned:

- When shopping:
  - Choose a variety of whole grains, fruits, and vegetables.
  - Choose low-fat or fat-free milk products, salad dressings, and mayonnaise.
  - Choose lean cuts of meat. Trim away extra fat.
  - Read Nutrition Facts labels to choose foods lower in saturated fat, *trans* fat, cholesterol, sodium, sugar, and calories.

- When cooking:
  - Use vegetable oil or soft tub margarine instead of butter, lard, or coconut oil.
  - Cook using low-fat methods, such as baking, steaming, broiling, or grilling (without added fat), rather than frying.
- When eating:
  - Eat foods that are low in saturated fat, *trans* fat, and added sugars.
  - Remove skin from poultry. Throw away the skin, and do not eat it.
  - Choose low-fat or fat-free milk products, salad dressings, and mayonnaise.
  - Eat no more than four egg yolks each week.
  - Eat fewer high-calorie foods with little added nutritional value, such as high-fat lunch meats, pies, cakes, cookies, crackers, and chips. Drink fewer sodas.
  - Eat smaller portion sizes.

■ **Say:**

There are creative ways to make healthier versions of Filipino foods that are traditionally high in fat and sodium. Experiment with your favorite recipes! For example, try using evaporated low-fat milk instead of cream when making *leche flan*.

■ **Say:**

Thank you for participating in this activity! You did great! Now you can make healthier choices for yourself and your family.

## 5. (Optional) Heart Healthy Scenarios With the de la Cruz Family: Group Activity



**Note:** This activity will help group members think about ways they can help their relatives and friends make healthier food choices. You may select one or more scenarios to review.

- **Give** group members the “Heart Healthy Scenarios With the de la Cruz Family” handout (pages 316–318).
- **Divide** group members into groups of three to five people, and **give** each group a different scenario (handout) to discuss.
- **Say:**



Each group will read the scenario on the handout and think about ways to solve the problems described. Please choose one member of your group to read the story and questions aloud to the group. Write down the group’s solutions to each of the questions.

- **Note:** Allow 5 to 7 minutes for group members to complete the activity.
- **Say:**

I would like one volunteer from each group to read the story and the answers to the questions aloud.



**Note:** After each volunteer reads the story and solutions, **ask** the entire group to share any other solutions.

### Heart Healthy Scenarios With the de la Cruz Family

#### Scene 1: Helena’s Fast Food Dilemma

Mila’s friend Helena is a busy, working mom with two children. She rarely makes dinner for her family because of her busy schedule. Helena takes her children to fast food restaurants three or four times a week. Her sons love eating hamburgers and french fries, drinking soda, and getting free toys. But she wants her children to live healthy lives. She is worried that they are spending too much time playing video games and watching television after school and meals. Combined with the fast food, Helena is worried that her sons will become overweight soon.





**Note:** Add the following answers to each question if they are not mentioned.

■ **What can Helena do on her busy schedule to feed her children healthy meals?**

- Helena could make meals in a slow cooker (Crock-Pot®) so they can cook during the day and be ready when she and her sons get home.
- She could buy roasted chicken instead of hamburgers and fries at fast food restaurants.
- She could buy steamed fish or vegetable dishes from a Chinese carryout restaurant.

■ **What else can Helena do to help her children live healthy lives?**

- She could limit the time her children spend playing video games and watching television.
- She could turn off Saturday morning cartoons and take her sons to a park or bike with them to the library instead.
- She could encourage her children to play active outdoor games instead of video games.
- When she does allow her children to watch TV, she could have them practice tai chi or play with a hula hoop at the same time.

## **Scene 2: Cesar's and Mila's Parties**

Cesar and Mila like to have parties at their house. They enjoy the company of their family and friends. They usually celebrate with a lot of food and drink. They love to make chicken, leaving the skin on, fried *lumpia* with pork, *sinangag* (garlic fried rice) with a lot of *patis* (fish sauce), and sweet desserts. Their gatherings start in the afternoon and usually last through the evening. Most of the time, they are sitting down eating and drinking alcohol. At least once a week, Cesar and Mila's friends take turns hosting parties at their houses.



**Note:** Add the following answers to each question if they are not mentioned.

■ **What can Cesar and Mila make for their own parties or bring to friends' parties to make them more heart healthy?**

- Water, unsweetened tea, and diet soft drinks
- Dishes of steamed fish or seafood, noodles or steamed rice, and vegetables
- Fresh lumpia
- Platters of sliced fresh fruit such as papaya, cantaloupe, pineapple, and mango.
- Lower-fat desserts such as *puto* and *mamon*.

■ **How can Cesar and Mila stick to their healthier eating plan when they are at the parties?**

- Eat smaller portions.
- Do not take second helpings of high-calorie foods. Eat fresh fruit if you are still hungry.
- Eat less food that is high in fat, such as fried foods.
- Eat fewer foods that are high in sodium, such as chips and sauces.
- Eat fewer foods that are high in fat and added sugar, such as desserts made with coconut milk, pastries, cookies, and chocolate.

■ **What else can Cesar and Mila do?**

- Eat a healthy snack before the party so they are not hungry.
- Take a walk after eating.
- Limit their alcohol to one drink for Mila and two drinks for Cesar.

### ***(Optional)* Scene 3: Eating When Stressed or Bored**

Jose is trying to stay heart healthy. His doctor says he needs to lower his blood pressure and lose some weight. But eating makes him feel better when he is stressed or bored. He says it takes his mind off his problems. Even when he is not hungry, Jose likes to snack on pork rinds, salted peanuts, and regular sodas while watching television.



**Note:** Add the following answers to each question if they are not mentioned.

#### **■ How can Jose eat better to lose weight and lower his blood pressure?**

- Jose could make it a practice to eat only when he feels hungry.
- He could eat fresh fruit or fat-free yogurt.
- He could eat fewer foods and sauces that are high in sodium.
- He could eat smaller portions.
- He could read Nutrition Facts labels to make sure he eats foods that are lower in calories, saturated and *trans* fat, cholesterol, sodium, and added sugar.
- He could eat more fruits, vegetables, whole grains, fat-free or low-fat milk products, and lactose-free products.

#### **■ What else can Jose do to lose weight and lower his blood pressure?**

- Jose could get 30 to 60 minutes of physical activity every day.
- He could dance or practice tai chi or yoga while he watches television.
- He could watch less television and walk or bike to a park, library, or fresh foods market.
- He could take his high blood pressure medicine as his doctor instructs.

#### **■ Ask the following questions:**

- What are some of the lessons we learned from these scenarios?
- Is there any part of a scenario that is similar to your own life?



**Note:** Allow 5 minutes for open discussion.

## 6. *Ampalaya* (Bitter Melon) With Pork Recipe



**Note:** This activity will give group members a chance to try a heart healthy recipe at home.

- Give group members the “*Ampalaya* (Bitter Melon) With Pork Recipe” handout (page 319).



- **Say:**

This dish contains lean meat and vegetables. It is also seasoned with herbs and spices. Try to prepare this at home this week.

## 7. Cooking With Children

- Give group members the “Cooking With Children” and “Cantaloupe Crush Recipe for Children” handouts (pages 320–322).



- Ask volunteers to read the “Cooking With Children” handout out loud.

- **Say:**

If you are parents, you can teach your children healthy eating habits. Lola says often, “*Ang gawa sa pagkabata, dala hanggang pagtanda.*” “What one learns in childhood is carried into adulthood.”

- **Say:**

For good health and proper growth, children need to eat a variety of different foods every day. If children are provided a balanced diet, they will develop good eating habits.

- **Say:**

The cantaloupe crush is a drink made from fresh fruit and milk. Children love this drink, especially on hot, summer days.

- **Ask:**

Can you think of other ways to get children involved in helping to prepare healthy meals?

- **Write** group members' suggestions on the blackboard or on a large piece of paper taped to the wall.

### More Information

*We Can!* (Ways to Enhance Children's Activity & Nutrition) is an education program to help children aged 8 to 13 maintain a healthy weight. The program includes tips for parents on healthy food choices and physical activity. Visit <http://wecan.nhlbi.nih.gov>.

## Review of Today's Key Points

- **Say:**

Let's review what we learned today.

- **Ask:**

### **What is heart healthy about the traditional Filipino diet?**

- The traditional Filipino diet provides a variety of foods that are lower in fat and sodium, such as steamed rice, bread, noodles, vegetables, fruits, lean meat, poultry, fish and seafood, low-fat and fat-free milk and milk products.

### **What are some foods that we should eat less often?**

We should limit foods that are high in saturated fat, *trans* fat, sodium, added sugar, and calories, including:

- Foods high in fat, such as *longanisa* (native sausage), fried *lumpia* (egg roll), *sinangag* (garlic fried rice), fried meat and vegetables, fatty meats, canned and processed meat, high-fat cheeses and creams, and banana chips
- Foods high in sodium, such as chips, canned meat and fish, and sauces and seasonings, such as *patis* (fish sauce), *bagoong* (salted fish or shrimp paste), *pusit* (dried, salty squid), *vetsin* or monosodium glutamate, and soy sauce

- Foods high in added sugar, such as candy and soft drinks
- Foods high in fat and added sugar, such as *halo-halo*, *bibingka* (cake with coconut milk and butter), pastries, cookies, and chocolate

**How can the heart healthy eating plan be used to choose heart healthy foods?**

- Use the heart healthy eating plan to choose foods that are lower in saturated fat, *trans* fat, cholesterol, sodium, and sugar from each of the five food groups. The eating plan also shows the number of servings you need from each group every day.

**Why is it helpful to know how much you need to eat from each food group each day?**

- When you know the amount of food you need to eat every day, it can help you get the right amount of calories you need.

## Lola’s Life Lessons: A Time To Reflect

■ **Say:**

In the last session, Lola Idad spoke to us about having the courage to be fearless. This week, Lola promotes heart health in our families by encouraging us to support each other in our efforts.

- **Give** each group member the “Lola’s Life Lessons: Session 8” handout (page 323). **Ask** a volunteer to read the handout.



■ **Say:**

Please take a few moments to reflect on Lola’s advice and how this applies to your life. At the bottom of the handout, there is a space called “A Time To Reflect.” Use this section to record your feelings about this week’s session. Please write down your thoughts. Remember, this is for you and no one else.

- **Give** each group member 2 to 3 minutes to write down some thoughts.

# Pledge for Life!



- Give each group member the “Pledge for Life! Session 8” handout (page 324).

- Say:

Take the pledge for life with Lola and her family. Pledge to do one thing on this list during the coming week. Now, let’s start by sharing our goals with each other.



**Note:** Tell group members to be very specific about what they plan to do. (For example, if they say they will eat smaller portions, ask them to name some ways they can do this.)

- Give each group member 2 to 3 minutes to share.

# Closing

- Say:

Thank you for coming today. What did you think of today’s session?



**Note:** Allow a moment for group members to respond.







- Say:

I am looking forward to seeing you again at the next session. We will talk about eating in a heart healthy way—even when time or money is tight.

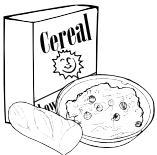

**Note for Educator:** Think about today’s session. What worked and what did not work? Have you made healthy changes in your food choices that were covered in today’s session?

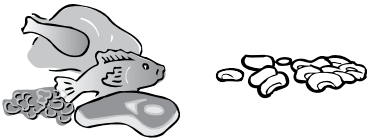

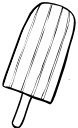
# Heart Healthy Eating Plan

<p><b>Grains</b> Rice, bread, cereal, and noodles (pasta) (6 to 8 servings a day)*</p> 	<ul style="list-style-type: none"> <li>♥ Noodles and steamed rice</li> <li>♥ Sliced bread (such as wheat, rye, or white), sandwich buns, dinner rolls, English muffins, bagels, and <i>pan de sal</i></li> <li>♥ Unsalted, low-fat crackers (such as graham crackers), unsalted pretzels, and plain popcorn</li> <li>♥ Cooked hot cereals (not instant) and whole-grain cold cereals</li> </ul>
<p><b>Fruits</b> (4 to 5 servings a day)*</p> 	<ul style="list-style-type: none"> <li>♥ Fresh, frozen, canned (packed in fruit juice), or dried fruits without added sugar (such as oranges, papaya, grapefruit, bananas, apples, mangoes, pineapples, watermelon, peaches, fruit cocktail, grapes with skin on, and raisins)</li> <li>♥ Fresh, frozen, or canned fruit juices (with no sugar added)</li> </ul>
<p><b>Vegetables</b> (without added fat) (4 to 5 servings a day)*</p> 	<ul style="list-style-type: none"> <li>♥ Fresh, frozen, or no-salt-added canned vegetables (such as peas, green beans, carrots, cabbage, tomatoes, yuca, squash, broccoli, potatoes, and corn)</li> <li>♥ Cooked dry beans, peas, and lentils</li> </ul>
<p><b>Fat-free and low-fat milk and milk products</b> Milk, yogurt, and cheese (choose low-fat more often) (2 to 3 servings a day)*</p>	<ul style="list-style-type: none"> <li>♥ Lactose-free products, such as soy milk and other soy products</li> <li>♥ Fat-free or low-fat (1%) milk</li> <li>♥ Fat-free or low-fat yogurt</li> <li>♥ Cheeses low in fat and sodium</li> </ul> 
<p><b>Lean meats, poultry, and fish</b> Meat, poultry, fish, seafood, dry beans, eggs, tofu, and nuts (2 or fewer servings a day)*</p> 	<ul style="list-style-type: none"> <li>♥ Chicken or turkey without the skin</li> <li>♥ Fish and seafood</li> <li>♥ Lean cuts of meat</li> <li>♥ Beef: round, sirloin, chuck, loin, and extra lean ground beef</li> <li>♥ Pork: leg, shoulder, tenderloin, and lean ham</li> <li>♥ Tofu</li> <li>♥ Dry beans and peas (black beans, pinto beans, kidney beans, navy beans, chickpeas, lentils, and split peas)</li> <li>♥ Frozen butter beans and lima beans</li> <li>♥ Eggs (no more than four yolks a week)</li> </ul>
<p><b>Nuts, seeds, and legumes</b> (4 to 5 servings a week)</p>	<ul style="list-style-type: none"> <li>♥ Nuts, peanut butter, and seeds</li> </ul>
<p><b>Fats and oils</b> (2 to 3 servings day)*</p> 	<ul style="list-style-type: none"> <li>♥ Margarine (liquid, soft tub, or reduced-calorie)</li> <li>♥ Oils (canola, corn, safflower, olive, peanut, or sesame)</li> </ul>
<p><b>Sweets and added sugars</b> (5 servings or fewer a week)*</p> 	<ul style="list-style-type: none"> <li>♥ Frozen treats (such as frozen juice pops, low-fat frozen yogurt, or ice cream)</li> <li>♥ Low-fat cake and cookies (such as angelfood cake, fig-bar cookies, gingersnaps, animal crackers, vanilla wafers, graham crackers, <i>puto</i>, and <i>mamon</i>)</li> </ul>

\* The amount of food from each food group that is right for you depends on how many calories you need. This is based on your age, gender, and how physically active you are.





# Plano sa Pagkaing Malusog sa Puso

<p><b>Mga Butil</b>            Kanin, tinapay, <i>cereal</i>, at mga <i>noodles (pasta)</i> (6 hanggang 8 takal sa isang araw)*</p> 	<ul style="list-style-type: none"> <li>♥ Mga <i>noodles</i> at sinaing na kanin</li> <li>♥ Putol ng tinapay (tulad ng <i>wheat, rye</i>, o puti), mga <i>sandwich bun, dinner roll, English muffin, bagel</i>, at pan de sal</li> <li>♥ Walang asin, mga <i>low-fat crackers</i> (tulad ng <i>graham crackers</i>), walang asin na mga <i>pretzel</i>, at walang halong <i>popcorn</i></li> <li>♥ Mga lutong mainit na <i>cereal</i> (hindi instant) at buong butil na <i>cereal</i></li> </ul>
<p><b>Mga Prutas</b>            (4 hanggang 5 takal sa isang araw)*</p>	<ul style="list-style-type: none"> <li>♥ Sariwa, naka-freeze, de lata (nakapaketeng katas ng prutas), o mga pinatuyong prutas nang walang dinagdag na asukal (tulad ng mga kahel, papaya, <i>grapefruit</i>, saging, mansanas, manga, pinya, pakwan, <i>peach, fruit cocktail</i>, ubas na may balat, at pasas)</li> <li>♥ Sariwa, naka-freeze, o de latang katas ng prutas (nang walang idinagdag na asukal)</li> </ul>
<p><b>Mga Gulay</b>            (nang walang idinagdag na taba)            (4 hanggang 5 takal sa isang araw)*</p>	<ul style="list-style-type: none"> <li>♥ Sariwa, naka-freeze, o walang idinagdag na asin sa de latang gulay (tulad ng mga <i>garbanzos, green beans, carrot</i>, repolyo, kamatis, <i>yuca</i>, kalabasa, <i>broccoli</i>, patatas, at mais)</li> <li>♥ Mga lutong tuyong <i>beans, garbanzos</i>, at patani</li> </ul>
<p><b>Fat-free at low-fat na gatas at mga produktong gawa sa gatas</b>            Gatas, <i>yogurt</i>, at keso (Piliin ang <i>low-fat</i> nang mas madalas)            (2 hanggang 3 takal sa isang araw)*</p>	<ul style="list-style-type: none"> <li>♥ Mga produktong <i>lactose-free</i>, tulad ng gatas ng soya at iba pang mga produktong gawa sa soya</li> <li>♥ Gatas na <i>fat-free</i> o <i>low-fat</i> (1%)</li> <li>♥ <i>Yogurt</i> na <i>fat-free</i> o <i>low-fat</i> (1%)</li> <li>♥ Mga kesong mababa sa taba at asin</li> </ul> 

\* Ang dami ng pagkain mula sa bawat pangkat ng pagkain na tama para sa iyo ay depende sa kung gaano karaming calorie ang kailangan mo. Ito ay batay sa iyong gulang at kasarian at kung gaano ka kaaktibong pisikal.

# Plano sa Pagkaing Malusog sa Puso *(continued)*

<p><b>Mga karneng kakaunti ang taba, manok, at isda</b>          Karne, manok, isda, pagkaing dagat, mga tuyong <i>beans</i>, itlog, tokwa, at <i>nut</i>          (2 o mas mababa pang takal sa isang araw)*</p> 	<ul style="list-style-type: none"> <li>♥ Manok o pabo na walang balat</li> <li>♥ Isda at pagkaing dagat</li> <li>♥ Mga hiwa ng karne na kakaunti ang taba              Baka: <i>round, sirloin, chuck, loin</i>, at sobrang kakaunti ang tabang giniling na baka              Baboy: <i>pata, shoulder, tenderloin</i>, at walang tabang hamon</li> <li>♥ Tokwa</li> <li>♥ Mga tuyong <i>bean</i> at <i>garbanzos</i> (mga <i>black beans, pinto beans, kidney beans, navy beans, chickpeas</i>, patani, at <i>split peas</i>)</li> <li>♥ Mga naka-freeze na <i>butter beans</i> at <i>lima beans</i></li> <li>♥ Mga itlog (hindi higit sa apat na pula ng itlog sa isang linggo)</li> </ul>
<p><b>Mga <i>nut</i>, buto, at legumes</b>          (4 hanggang 5 takal sa isang linggo)*</p> 	<ul style="list-style-type: none"> <li>♥ Mga <i>nut, peanut butter</i>, at buto</li> </ul>
<p><b>Mga <i>fats</i> at <i>oils</i></b>          (2 hanggang 3 takal sa isang araw)*</p>	<ul style="list-style-type: none"> <li>♥ <i>Margarine</i> (likido, <i>soft-tub</i>, o binawasan ng calorie)</li> <li>♥ <i>Oils</i> (<i>canola, corn, safflower, olive, peanut</i>, o <i>sesame</i>)</li> </ul>
<p><b>Mga matatamis at idinagdag na asukal</b>          (5 takal o mas mababa pa sa isang linggo)*</p>	<ul style="list-style-type: none"> <li>♥ Mga <i>frozen treats</i> (tulad ng naka-freeze na <i>juice pops</i>, naka-freeze na <i>low-fat yogurt</i>, o sorbetes)</li> <li>♥ <i>Low-fat</i> na <i>keyk</i> at mga <i>cookies</i> (tulad ng <i>angel food cake</i>, mga <i>fig bar cookies, gingersnaps</i>, mga biskwit na hugis hayop, <i>vanilla wafers, graham crackers</i>, puto, at mamon)</li> </ul>

\* Ang dami ng pagkain mula sa bawat pangkat ng pagkain na tama para sa iyo ay depende sa kung gaano karaming calorie ang kailangan mo. Ito ay batay sa iyong gulang at kasarian at kung gaano ka kaaktibong pisikal.

# Add Color and Flavor to Your Menu

## BREAKFAST

**Omelet**

*Pan de sal*

**Coffee with fat-free milk**

\_\_\_\_\_  
Vegetable



\_\_\_\_\_  
Fruit



# Add Color and Flavor to Your Menu *(continued)*

---

## LUNCH

**Grilled fish**

**Steamed rice**

\_\_\_\_\_  
Vegetable

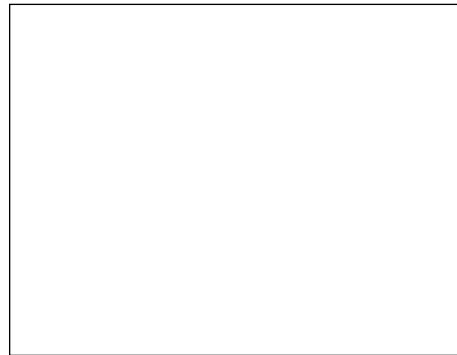

\_\_\_\_\_  
Vegetable



\_\_\_\_\_  
Fruit



# Add Color and Flavor to Your Menu *(continued)*

---

## **DINNER**

**Roasted pork**

**Noodles**

\_\_\_\_\_  
Vegetable

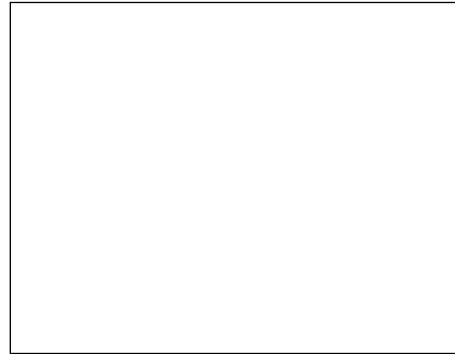

\_\_\_\_\_  
Vegetable



\_\_\_\_\_  
Fruit



# Add Color and Flavor to Your Menu *(continued)*

---

## **SNACK**

\_\_\_\_\_

Vegetable

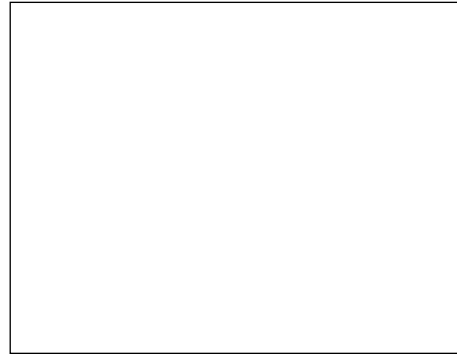

\_\_\_\_\_

Fruit

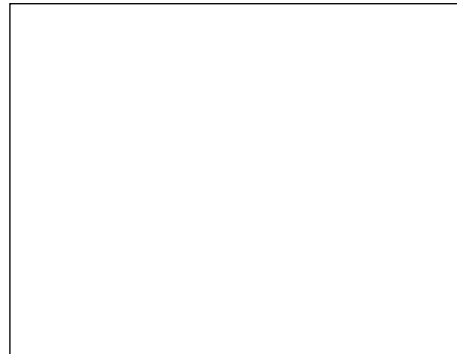

# Say Yes to Fruits and Vegetables

## Vegetables



Frozen peas  
and carrots

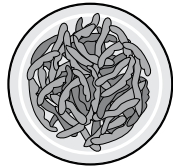

Green beans



Spinach



Broccoli



Tomatoes



Bok choy  
(*pechay*)

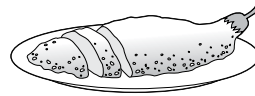

Eggplant

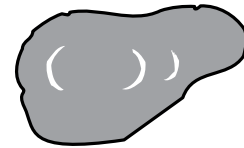

Sweet Potato  
(*camote*)

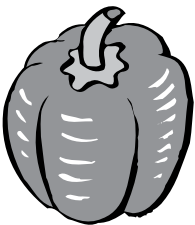

Pepper

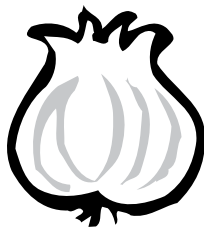

Green onions



Cucumber



Cabbage

Cut out these foods, and use them for the activity.

# Say Yes to Fruits and Vegetables *(continued)*

## Fruits

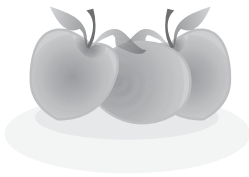

Cherries

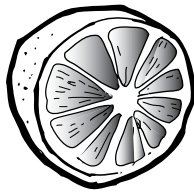

Grapefruit



Canned peaches  
in fruit juice

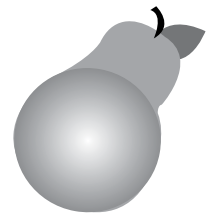

Papaya

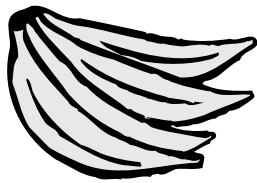

Banana

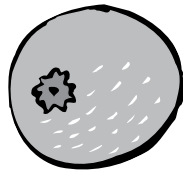

Orange



Apple

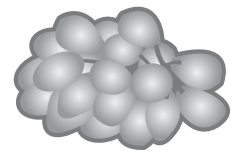

Grapes

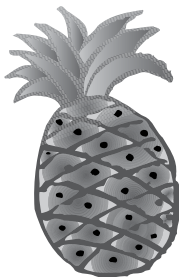

Pineapple



Mango



Peach



Guava

Cut out these foods, and use them for the activity.



# Heart Healthy Scenarios With the de la Cruz Family

---

## ■ Scene 1: Helena’s Fast Food Dilemma

Mila’s friend Helena is a busy, working mom with two children. She rarely makes dinner for her family because of her busy schedule. Three or four days a week, Helena takes her children to fast food restaurants. Her sons love eating hamburgers and french fries, drinking soda, and getting free toys. But she wants her children to live healthy lives. She is worried that they are spending too much time playing video games and watching television after school and meals. Combined with the fast food, Helena is worried that her sons will become overweight soon.

**What can Helena do on her busy schedule to feed her children healthier meals?**

---

---

---

**What else can Helena do to help her children live healthy lives?**

---

---

---

# Heart Healthy Scenarios With the de la Cruz Family *(continued)*

---

## ■ Scene 2: Cesar and Mila’s Parties

Cesar and Mila like to have parties at their house. They enjoy the company of their family and friends. They usually celebrate with a lot of food and drink. They love to make chicken, leaving the skin on it, *pancit*, fried *lumpia* with pork, *sinangag* (garlic fried rice) with a lot of *patis* (fish sauce), and sweet desserts. Their gatherings start in the afternoon and usually last through the evening. Most of the time, they are sitting down eating and drinking alcohol. At least once a week, Cesar and Mila’s friends take turns hosting parties at their houses.

**What can Cesar and Mila make for their own parties or bring to friends’ parties to make the celebrations more heart healthy?**

---

---

---

**How can Cesar and Mila stick to their healthier eating plan when they are at the parties?**

---

---

---

**What else can Cesar and Mila do?**

---

---

# Heart Healthy Scenarios With the de la Cruz Family *(continued)*

---

## ■ **Scene 3: Eating When Stressed or Bored**

Jose is trying to stay heart healthy. His doctor says he needs to lower his blood pressure and lose some weight. But eating makes him feel better when he is stressed or bored. He says it takes his mind off his problems. Even when he is not hungry, Jose likes to snack on pork rinds, salted peanuts, and regular sodas while watching television.

**How can Jose eat better to lose weight and lower his blood pressure?**

---

---

---

**What else can Jose do to lose weight and lower his blood pressure?**

---

---

---

# Ampalaya (Bitter Melon) With Pork Recipe

1 tablespoon	olive oil
½ pound (0.2 kg)	lean ground pork
6 cloves	garlic, crushed
1 cup	onion, 1 medium, chopped
2 cups	<i>Ampalaya</i> ,* sliced
2 teaspoons	light soy sauce
½ teaspoon	black pepper

\* *Ampalaya* (bitter melon) is a fruit that is oblong, cylindrical, pointed at both ends, ribbed, and wrinkled.

## Quick Facts

This recipe is lower in fat and sodium because it uses:

- Lean meat that is sauteed and simmered instead of fried
- Onion, garlic, and bitter melon for flavor
- Low-sodium soy sauce that reduces the amount of sodium in the dish

1. Using a large skillet, lightly saute onions and garlic in hot olive oil.
2. Add the ground pork and cook until almost done.
3. Add the sliced bitter melon.
4. Cover and simmer until bitter melon turns green. Do not overcook.
5. Season with light soy sauce and black pepper.

<b>Yield:</b>	<b>Serving size:</b>
<b>4 servings</b>	<b>1 cup</b>
Calories	150 kcal
Total Fat	6 g
Saturated Fat	1.5 g
Cholesterol	45 mg
Sodium	200 mg
Total Fiber	1 g
Protein	17 g
Carbohydrates	7 g
Potassium	600 mg

Source: Adapted from Heart Healthy Traditional Filipino Recipes, American Heart Association.

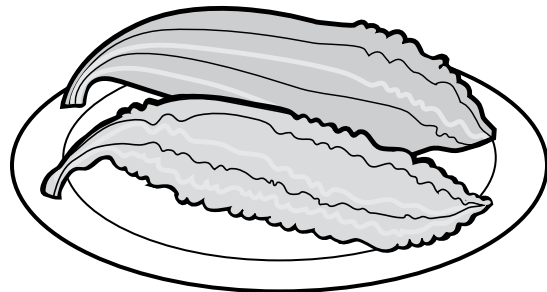

# Cooking With Children

## Get Them Interested

Cooking with your children is a good way to help them develop healthy eating habits. Most children enjoy helping in the kitchen. While they help you prepare a meal, you can talk to them about healthy foods. Children like to eat the food they make. This is also a good way to get them to try more healthy foods.

## Let Them Help

You can show your children how to help you prepare meals. Here are ways that children of different ages can help in the kitchen:

### 2-year-olds can:

- Wipe tabletops.
- Scrub and rinse fruits and vegetables.



- Tear lettuce or greens.
- Break up broccoli.
- Bring ingredients from one place to another.

### 3-year-olds can:

- Wrap potatoes in foil for baking.
- Knead and shape dough for ensaymada (sweet bread).
- Mix ingredients.
- Pour liquids.



- Shake liquids in a covered container.
- Apply soft spreads.
- Shape the edges of the empanadas.
- Wrap lumpia rolls.
- Make dumplings.
- Put things in the trash.

### 4-year-olds can:

- Peel oranges or hard-boiled eggs.
- Mash bananas with a fork.



- Cut basil with kid-safe scissors.
- Set the table.

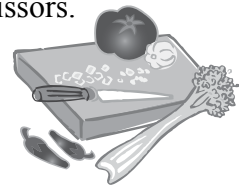

### 5- to 6-year-olds can:

- Measure ingredients.
- Use an egg beater.



- Cut crusts off bread for sandwiches.

Be sure to have children wash their hands before and after helping in the kitchen. Be patient with spills and mistakes. Remember that the goal is to help your children learn about healthy eating.

# Cooking With Children *(continued)*

## Let Them Be Creative

Set out three or four healthy foods, and let your children make a new snack or sandwich from them. Use foods your children can eat without choking.



### Start with:

- A new kind of bread (whole grain or rye)
- Whole-grain crackers or graham crackers
- Mini rice cakes or popcorn cakes
- Small bagels
- Salt-free crackers

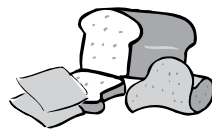

### Spreads could include:

- Low-fat cream cheese or cheese spread
- Low-fat peanut butter



- Jelly or jam with no sugar added

### Toppings could include:

- Slices of banana, pineapple, or cherries
- Raisins or other dried fruit
- Strawberries
- Slices of cucumber or squash



- Cherry tomatoes cut in small pieces
- Slices of cheese or hard-boiled egg
- Basil leaves or dill

As you help your children make the new snack or sandwich, talk about why it is healthy.

Point out the different food groups that are included in the snack or sandwich. Explain that eating a variety of foods is healthy.

Ask why the snack or sandwich tastes good. Is it sweet, juicy, chewy, or crunchy?

Adapted from the U.S. Department of Agriculture, "Tips for Using the Food Guide Pyramid for Young Children 4 to 6 Years Old."

# Cantaloupe Crush Recipe for Children

½	cantaloupe
1 cup	fat-free milk
1½ cups	ice
sweetener	as needed (about 1 to 2 teaspoons sugar or equivalent of other sweetener)

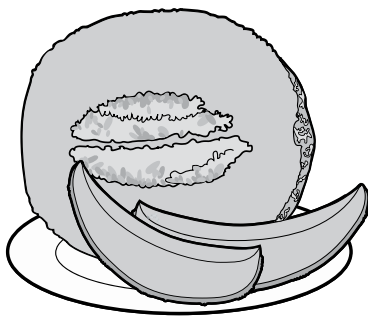

## Quick Facts

This refreshing drink is healthy because it uses:

- Fresh fruit
- Fat-free milk
- Low amounts of sweetener

1. Cut cantaloupe into small cubes or thin strips.
2. Mix cantaloupe, milk, and ice in a blender until smooth.
3. Sweeten to taste.

<b>Yield:</b>	<b>Serving size:</b>
<b>4 servings</b>	<b>½ cup</b>
Calories	50 kcal
Total Fat	0 g
Saturated Fat	0 g
Cholesterol	0 mg
Sodium	40 mg
Total Fiber	0 g
Protein	3 g
Carbohydrates	10 g
Potassium	280 mg

Source: National Cancer Institute recipe at IntelliHealth, available at:  
<http://www.intelihealth.com/IH/ihtIH/WSSAN283/2372/14218/232586.html?sID=325>

# Lola's Life Lessons: Session 8

---

One of my favorite proverbs is:

*“Ang mabigat ay gumagaan, kung pinatutulngan.”*

Translation: “A heavy burden is lightened if everyone participates in carrying it.”

The journey to heart health has many challenges. But it is much easier if your family and friends support you. When I first started changing my eating habits, it was hard to go to parties and gatherings. The parties always have delicious dishes on the table, but the sauces are usually high in fat and sodium. In the beginning, I would taste everything on the table because I did not want to offend the host. Sometimes, I would try to go to the gatherings after dinner was served, because it made it easier to say no.

Eventually, I learned to eat smaller portions of my favorite foods. It is a lot easier now that my family has joined me on the journey to heart health. We bring low-fat, low-sodium dishes to share at potluck dinners. At parties, we remind each other to eat well-balanced meals. But I am most proud of my grandchildren, who are following their parents' example by making smart, healthy food choices each day.

## **A Time To Reflect...**

What changes has your family made in order to become heart healthy? What new changes can you make to support your family's journey to heart health?

(Use this space to write down your thoughts for this week's session.)



# Pledge for Life! Session 8

---

Take the pledge for life with Lola Idad. Try to do one of these activities by yourself or share with others.

- Learn the serving sizes for foods.
- Limit the intake of saturated and *trans* fat, cholesterol, and sodium, as well as added sugar.
- Eat smaller portions of food, starting with smaller portions of meat, steamed rice, and noodles.
- Avoid having second helpings of food.
- Choose a variety of fruits and unsalted nuts for healthy snacks.
- Bring carrot and celery sticks to work for a snack.
- Add fruits, like bananas or raisins, to cereal or oatmeal.
- Choose fewer snacks that are high in fat, sodium, and added sugar.
- Choose water or sugar-free drinks.
- Share heart healthy recipes with your family and friends.
- Other \_\_\_\_\_

# Eat in a Heart Healthy Way—Even When Time or Money Is Tight

---

## Objectives

By the end of this session, group members will learn:

- Quick and easy food preparation and mealtime tips
  - How to eat out in a heart healthy way
  - How to save money on food bills
- 

## Materials and Supplies

To conduct this session, you will need:

- “Healthy Heart, Healthy Family” manual and picture cards
- Examples of advertisements from magazines\*
- Blackboard and chalk or several large pieces of paper, markers, and tape
- Pencils

---

\* Prepare before the session.

---

## Handouts

**Give each group member these handouts during this session:**

- “Tips for Busy Families” (pages 344–346)
- “Rose’s Busy Schedule” (page 347)
- “Lola’s Tips for Heart Healthy Chinese Food” (pages 348–349)
- “Tips for Eating Out the Heart Healthy Way” (pages 350–352)
- *(Optional)* “Eating Out With the de la Cruz Family Role Play” (page 353)
- “Money-Saving Tips” (page 354)
- “Shopping List” (page 355)
- “What \$10 Can Buy (page 356)
- “Vegetable *Kare-Kare* (Peanut Stew) Recipe” (page 357)
- “Lola’s Life Lessons: Session 9” (page 358)
- “Pledge for Life! Session 9” (page 359)

---

## Session Outline

### Introducing the Session

1. Welcome
2. Review of Last Week’s Session
3. About This Session

### Conducting the Session

1. Eat in a Heart Healthy Way Even When There Is Little Time
  - A. Busy Times

- B. Quick and Easy Meal Tips
- C. Eating Out
- 2. Save Money on Your Food Bill
  - Money-Saving Tips
- 3. Food Advertising Activity
- 4. Vegetable *Kare-Kare* (Peanut Stew) Recipe

## **Review of Today’s Key Points**

### **Lola’s Life Lessons: A Time To Reflect**

### **Pledge for Life!**

### **Closing**

## **Introducing the Session**

---

### **1. Welcome**

Welcome group members to the session.

### **2. Review of Last Week’s Session**

■ **Say:**

Let’s review some of the lessons we learned last session.

## ■ Ask:

### **What is heart healthy about the traditional Filipino diet?**

The traditional Filipino diet provides a variety of foods that are lower in fat and sodium, such as bread, noodles (pasta), steamed rice, vegetables, fruits, poultry, fish and seafood, low-fat and fat-free milk and milk products, and lactose-free products such as soy milk.

### **What are some foods that we should eat less often?**

We should limit foods that are high in saturated fat, *trans* fat, sodium, sugar, and calories, including:

- High-fat foods, such as *longanisa* (native sausage), fried *lumpia* (egg roll), *sinangag* (garlic fried rice), fried meat and vegetables, fatty meats, canned and processed meat, high-fat cheeses and creams, and banana chips
- Salty foods and sauces, such as potato chips and bagoong
- High-fat and high-sugar foods, such as *bibingka* (sweet rice cake) and other pastries, cookies, and chocolate
- Sugary foods, such as candy and soft drinks

### **How can the heart healthy eating plan be used to choose heart healthy foods?**

Use the heart healthy eating plan to choose foods that are lower in saturated fat, *trans* fat, cholesterol, sodium, and sugar from each of the five major food groups. The eating plan also shows you the number of servings that you need from each group every day.

### **Why is it helpful to know how much you need to eat from each food group each day?**

When you know the correct amounts of food you need to eat every day, it can help you get the right amount of calories you need.

■ **Ask:**

Would anyone like to share his or her pledge from last week? What went well? What did not work well?



**Note:** Allow about 2 to 3 minutes for group members to respond.

### **3. About This Session**

■ **Say:**

Today, you will learn how to eat in a heart healthy way—even when you have very little time and are on a tight budget. During this session, you will learn:

- Quick and easy ways to prepare heart healthy meals
- How to eat right when eating out
- How to make smart food-buying choices that meet your family’s needs and budget
- How advertising can cause us to buy things that cost more or things we do not need

■ **Say:**

According to Lola Idad, “*Ang taong matalino ay hindi tumitingin sa pagyapak ng paa niya sa lupa. Binabantayan niya ang kanyang kasunod na hakbang.*”  
“A wise man does not see his foot on the ground; he watches his next step.”

■ **Say:**

Lola encourages her family to make heart healthy eating a priority. Her family will share some tips on how to eat heart healthy meals on a budget later in this session.

# Conducting the Session

---

## 1. Eat in a Heart Healthy Way Even When There Is Little Time

### A. Busy Times

#### ■ Say:

Many people have little time to shop, prepare food, and clean up after meals. This session will help you eat in a heart healthy way, even when you are in a rush.

#### ■ Say:

Busy people may think they do not have time to eat in a heart healthy way. These people may:

- Skip breakfast and lunch, and eat one big meal in the evening.
- Eat out or order carryout food several times per week.
- Buy boxed, instant, or already-prepared foods.
- Buy food from vending machines.

#### ■ Ask:

What foods do you eat when you don't have time to cook?



**Note:** Allow about 5 minutes for group members to respond. **Write** their answers on the blackboard or on a large piece of paper taped to the wall.

■ **Say:**

Eating on the run often means that we are eating foods that are higher in fat, sodium, sugar, and calories. For example, we eat snacks and candy from vending machines or high-fat hotdogs and fried foods from fast food restaurants.

■ **Say:**

People often eat these foods because they are easy to buy or quick to prepare. When people are in a hurry, they often do not think about what kinds of foods are heart healthy.

■ **Say:**

They may also eat bigger portions of foods that are higher in fat and calories when there is no time to prepare healthy side dishes, such as salad, vegetables, or steamed rice.

## **B. Quick and Easy Meal Tips**



**Note:** This part of the session will help group members think about ways to prepare meals in less time.

■ **Say:**

People often find that they are too tired to prepare the kinds of meals they would like their families to eat. Today, we will learn some ways to save time and make meal preparation easier.

- **Give** each group member the “Tips for Busy Families” handout (pages 344–346).



**Note:** **Show picture cards** when you review sections under “Tips for Busy Families.” **Show picture card 9.1** when you review the “Plan Your Meals” and “Use a Shopping List” sections of the handout. **Show picture card 9.2** when you review the “Cook in Advance” section.

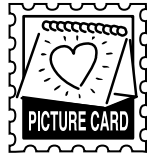

- **Ask** for volunteers to read the tips aloud, one at a time. Allow group members to comment as the tips are read.



■ **Ask:**

Would you find any of these tips difficult to carry out?



**Note:** Allow 3 to 5 minutes for group members to respond.

**Group Activity**



**Note:** This activity will help group members think about creative ways a family can enjoy heart healthy meals even when time is limited.

- **Divide** participants into groups of three or four people. **Give** group members the “Rose’s Busy Schedule” handout (page 347).



■ **Say:**

I am going to read a real-life situation. You can follow the story on the handout. Think about how Rose can solve her problem.

**Rose’s Busy Schedule**

Rose has a busy life. She has three young children, and she and her husband work Monday through Friday. Rose’s husband, Jose, leaves for work at 5:30 a.m. and gets home at 7:30 p.m. Rose usually leaves for the office at 9 a.m. and gets home around 6 p.m.

Every night, after she comes home from work, Rose gets the family’s dinner ready. She wants the family to be heart healthy, but she never seems to have the time to cook. Often, she is running late or is too tired to cook, so she picks up pizza, Chinese food, or fried chicken on her way home.

Since his stroke, Jose wants her to make healthier, traditional Filipino dinners. Rose tries to get her husband to help her with dinner, but he is always tired. Besides, Jose does not like cooking. They also have to help the children with their homework. This leaves them little time to prepare heart healthy meals.

- **Ask** each small group to discuss ways that Rose can make sure her family eats in a heart healthy way.



**Note:** Allow about 5 minutes for the groups to come up with suggestions.

- **Ask** one person from each group to present his or her group's suggestions to the entire group.
- **Add** these ideas if they are not mentioned:
  - Rose could cook two or three meals over the weekend and store them in the freezer.
  - She could make meals in a slow cooker (Crock-Pot<sup>®</sup>), which saves time during the evenings. Meals cook during the day and are ready when the family gets home.
  - Rose's family could help her by putting casseroles (from the freezer or made the night before) into the oven before she gets home.
  - Several families could get together and share meals.
  - Rose's family could help her by setting the table and doing the dishes.
  - Rose could buy roasted chicken instead of fried.
  - Rose could buy steamed fish or vegetable dishes (instead of fried) from the Chinese restaurant.

## C. Eating Out



**Note:** This activity will teach group members how to make heart healthy choices at fast food restaurants.

- **Ask:**

Where do you eat when you eat out?



**Note:** Allow about 3 minutes for group members to respond. **Write** their answers on the blackboard or on a large piece of paper taped to the wall.

■ **Say:**

Many people eat at fast food restaurants because:

- The food is served quickly.
- The food tastes good.
- The food is less expensive than food at sitdown restaurants.
- Special food and toys appeal to children.
- There may be a playground for children.

■ **Say:**

Many fast foods can be higher in saturated fat, sodium, and calories, but you can choose healthier foods from the menu.

- **Show picture card 9.3.** Keep it on display while you review the handout.

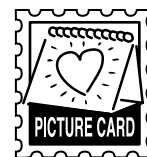

- **Give** each group member the “Lola’s Tips for Heart Healthy Chinese Food” handout (pages 348–349) and “Tips for Eating Out the Heart Healthy Way” handout (pages 350–352).

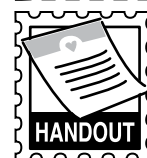

- **Ask** for volunteers to read the suggestions on the handouts aloud.

■ **Say:**

Do you have other ideas for making heart healthy choices at restaurants?



**Note:** Allow 2 or 3 minutes for group members to respond. **Write** their answers on the blackboard or on a large piece of paper taped to the wall.

■ **Say:**

Let’s talk briefly about buffet-style and “all-you-can-eat” restaurants. They may seem like money-saving restaurant choices that allow you to enjoy your favorite dishes at one time. But you may be tempted to overeat at these restaurants in order to get “the most” for your money. Try choosing buffet and “all-you-can-eat” restaurants less often.

■ **Say:**

If you do go to a buffet-style restaurant, make heart healthy choices, such as baked, steamed, broiled, and grilled lean meats and fish, and steamed or sauteed vegetables without sauces. Many of the sauces are high in sodium and calories. Also, watch your portions. It isn't a good deal to overeat because, eventually, you may pay a price with your health.

■ **Say:**

Let's talk about how the de la Cruz family handles eating out at their favorite Chinese buffet restaurant.

- *(Optional)* Give each group member the “Eating Out With the de la Cruz Family Role Play” handout (page 353). **Ask** for three volunteers to be actors for the role play.



**Note:** Allow 5 minutes for open discussion.

■ **Ask** the following questions:

- What are some of the lessons we learned from this role play?
- Is there any part of the play that you can use in your own life?

## 2. Save Money on Your Food Bill

### Money-Saving Tips

■ **Ask:**

What do you do to save money on food?



**Note:** Allow about 5 minutes for group members to respond. **Write** their answers on the blackboard or on a large piece of paper taped to the wall.

■ **Say:**

There are things you can do to save money on your food bill. Let's go over a list of ideas.

- Give each group member the “Money-Saving Tips” handout (page 354). Ask for volunteers to read the tips aloud.



- Give each group member the “Shopping List” handout (page 355).



- Say:

You can use this shopping list when you go to the store. Just check off or write on the blank lines what you want to buy.

- Give group members the “What \$10 Can Buy” handout (page 356).



- Say:

Healthy food and snacks do not have to be expensive. Look at the two shopping lists on the “What \$10 Can Buy” handout. Which list has more affordable and healthier food choices? Which list is the better buy?

- Say:

The items on the second list are lower in saturated fat, *trans* fat, and sodium. These foods also make easy, healthy snacks and can be added to bag lunches or used as ingredients for main dishes.

- Say:

These lists show us that eating heart healthy on a tight budget is possible. Remember to plan ahead and make smart, heart healthy choices when you are at the grocery store. This will help you stay within your budget.

### 3. Food Advertising Activity



**Note:** This section will help group members become more aware of how advertising plays into their food-buying decisions.

■ **Say:**

Food advertising is big business.

- Advertisements try to get adults and children to buy certain products.
- Advertising costs money. Billions of dollars are spent on food advertising. The people buying the food—the consumers—pay for this.
- Nationally advertised items usually cost more than store brands and brands that are not nationally advertised.
- Most people are more likely to buy items with fancy, eye-catching packaging.
- People can be very loyal to certain brands. They will often buy these products even if they cost more.

- **Ask** group members to describe advertisements that have persuaded them to buy certain products.



**Note:** Allow about 3 minutes for group members to respond.

- **Review** different advertising themes that are used to get people to buy food products. (**Show** or **describe** an example of the following advertising themes. **Prepare** these examples before the session.)



**Note:** As you discuss the six themes, **write** them on the blackboard or on a large piece of paper taped to the wall. You will need these themes for the group activities.

■ **Say:**

Popular advertising themes often focus on family, health, sex appeal, humor, appearance, and famous people.

• **Family**

Advertisers try to get you to use their products based on your love for your family. This works well because the family plays an important role in the Filipino community. Ads with a family theme often target women because of their role as family caregivers.

- **Health**  
Some advertisements focus on the positive health effects of using certain products. This works because people care about their health.
- **Sex appeal**  
Sex appeal sells products. Many people want to believe that they also will be beautiful and sexy if they use the advertised product.
- **Humor**  
A funny advertisement often helps people remember a product.
- **Appearance**  
Food advertisers show food that may look better than the real thing. This makes people want to try the product.
- **Famous people**  
Famous people are used to sell products. Advertisers can also have a celebrity use a product in a television show or movie.

## Group Activity



**Note:** This activity will help group members think about how advertising affects how we buy food.

- **Divide** the group members into smaller groups of three or four people. Give each group two to three advertisements that you have collected.
- **Say:**

I have given you real advertisements. Discuss with your group which themes are used in the advertisements.



**Note:** Allow about 5 minutes for the groups to come up with their ideas.

- **Ask** one person from each group to present his or her group's ideas to the others.
- **Say:**

Advertising can be helpful, because it tells people about different products they can buy. But ads can also get people to buy products that they do not need or cannot afford, or products that appear better than they really are.

■ **Ask:**

What can you ask yourself when you are trying to decide what brand to buy?



**Note:** Allow 4 to 5 minutes for group members to respond.

■ **Add** the following questions if they are not mentioned:

- Do I really need it?
- Is there a less expensive product that serves the same purpose?
- Have I compared the product’s Nutrition Facts label with an item that costs less?
- Am I buying the product because it comes in a nice package?
- Am I buying the product because the advertisement says it will make me look better or help me lose weight?
- Am I buying it because I have a coupon or because it’s on sale?
- Can I afford it, even with a coupon?
- Can I wait until it goes on sale?

■ **Say:**

Even if you want to buy name brands, you can save money by buying the products when they are on sale.

## 4. Vegetable *Kare-Kare* (Peanut Stew) Recipe

- **Give** group members the “Vegetable *Kare-Kare* (Peanut Stew) Recipe” handout (page 357). **Ask** them to try this dish sometime this week.

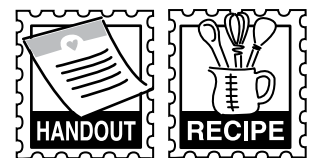

■ **Ask:**

How can this dish help us eat in a heart healthy way when we have little time?



■ **Add** these answers if they are not mentioned:

- This dish can be prepared in advance and frozen, so you can save time.
- It includes a lot of vegetables.

## Review of Today's Key Points

---

■ **Say:**

Let's review what we learned today.

### **What can you do to save time in meal preparation?**

- Get help from your spouse.
- Cook several dishes at one time, and freeze part of them.
- Make larger quantities, and use the leftovers for lunch.
- Pack lunches the night before.
- Learn simple, fast recipes.
- Use a slow cooker.

### **What can you do to eat healthier when eating out?**

- Try choosing buffet and “all-you-can-eat” restaurants less often.
- Order sandwiches without mayonnaise or sauces (or with low-fat mayonnaise or sauces).
- Order small, plain hamburgers or lean roast or chicken sandwiches instead of deluxe sandwiches.
- Ask for low-fat salad dressing, or bring your own.
- Choose water, 100% fruit juice, or fat-free or low-fat (1%) milk instead of a soft drink or a milkshake.

- Order smaller portions.
- Choose baked, broiled, steamed, or grilled foods instead of fried foods.
- Order steamed rice instead of fried rice at Asian restaurants.
- Remove the skin from chicken, and do not eat it.
- Choose vegetarian pizza, and ask for less cheese.
- Order a green vegetable or salad instead of two or more starches (such as potatoes, rice, noodles, bread, and corn).
- Make sure the restaurant does not use monosodium glutamate (MSG) in the dishes.
- Use less soy sauce or use light soy sauce. Try other low-sodium sauces or herbs to flavor foods.

**What can you do to save money when shopping?**

- Plan weekly meals, and make a shopping list of what you need to buy for the week.
- Use a shopping list, and don't go to the store too often.
- Check the food sale ads.
- Choose prepared foods less often.
- Buy only the amount of food your family needs.
- Shop alone, when possible, and make sure you're not hungry.
- Check your receipt for errors at the cash register.
- Try not to shop at convenience stores.
- Try store brands, and use them as often as possible.

# Lola's Life Lessons: A Time To Reflect

■ **Say:**

Last week, Lola Idad reminded us of the important role our families play in our journey to heart health. This week, Lola shows us how planning ahead can keep our budgets balanced and our lives heart healthy.

- **Give** each group member the “Lola’s Life Lessons: Session 9” handout (page 358). **Ask** a volunteer to read the handout.



■ **Say:**

Please take a few moments to reflect on Lola’s advice and how this applies to your life. At the bottom of the handout, there is a space called “A Time To Reflect.” Use this section to record your feelings about this week’s session. Please write down your thoughts. Remember, this is for you and no one else.

- **Give** each group member 2 to 3 minutes to write down some thoughts.

# Pledge for Life!

- **Give** each group member the “Pledge for Life! Session 9” handout (page 359).



■ **Say:**

Take the pledge for life with Lola and her family. Pledge to do one heart healthy activity on the list to save time and money. Now, let’s start by sharing our goals with each other.



- **Give** each group member 2 to 3 minutes to share.

■ **Say:**

Remember to continue using the skills you learned in other sessions, and keep working on your pledges to:

- Be physically active.
- Cut back on saturated fat, cholesterol, salt and sodium, and calories in your diet.
- Keep a healthy weight.

## Closing

---

■ **Say:**

Thank you for coming today. What did you think of today's session?



**Note:** Allow a moment for group members to respond.

■ **Say:**

I am looking forward to seeing you at the next session. The next session will be on living smoke free.



**Note for Educator:** Think about today's session. What worked and what did not work? Have you decided to make any changes to eat in a heart healthy way even when money and time are tight?

# Tips for Busy Families



## Plan Your Meals

- ♥ Plan weekly meals based on your family's schedule.

## Use a Shopping List

- ♥ Save money and time by making only one trip to the store. Make and use a shopping list.



## Share Meal Preparation Tasks

- ♥ Teach your family how to shop for groceries.
- ♥ Include children and other members of your family in preparing meals and cleaning up.
- ♥ Clean up as you cook—you will have less to clean up after you finish cooking.
- ♥ Share cooking duties with other family members or neighbors. For example, your family can cook enough food to share with another family.

## Cook in Advance

- ♥ Prepare some foods in advance, such as spaghetti sauce. Use these foods for quick meals. You can add chicken or beef to the sauce and serve it over spaghetti or rice.
- ♥ Prepare parts of a meal the night before (for example, marinate chicken in the refrigerator overnight).
- ♥ Pack your lunch the night before.
- ♥ Cut and wash vegetables, and make enough salad for 2 days. Do not add dressing until serving time.
- ♥ Cook two or three dishes on your day off, and freeze some of them. Use the frozen dishes on the days when you do not have time to cook.
- ♥ Prepare for recipes the night before by cutting and trimming meats.
- ♥ Prepare meals in a slow cooker.

## Cook Simply

- ♥ Steam vegetables, and serve them without sauces.
- ♥ Use frozen vegetables without sauces.
- ♥ Broil, steam, grill, bake, or roast meats.
- ♥ Make one-pot meals, such as stews and casseroles.
- ♥ Use frozen chopped vegetables, such as carrots, peas, and broccoli.
- ♥ Use the microwave for cooking or defrosting.
- ♥ Learn simple recipes that can be made in less than 30 minutes.

## Use Herbs and Spices

- ♥ Chop fresh herbs, and place in ice cube trays. Fill trays with water, and freeze. Store the frozen cubes in a plastic bag. Use when you need fresh herbs.
- ♥ Grow bay leaves, basil, or thyme on a sunny windowsill.
- ♥ Keep dried herbs on hand. One teaspoon of dried herbs is equal to 3 teaspoons of fresh herbs.

## Keep Quick Snacks on Hand

- ♥ Try these healthy snacks:
  - Fresh fruits and vegetables
  - Whole-grain, ready-to-eat, dry cereal
  - Polvorones (whole-wheat candy)
  - Fat-free and low-fat cheese
  - Unsalted nuts, seeds, and crackers
  - Whole-grain breads



# Mga Payo para sa Mga Pamilya na Abala



## Iplan ang Iyong Mga Pagkain



- ♥ Iplano ang lingguhang mga pagkain batay sa iskedyul ng iyong pamilya.

## Gumamit ng isang Listahan ng Pamimili

- ♥ Sa isang paglalakbay lamang papunta sa tindahan ay makakatipid ng pera at oras. Gumawa at gumamit ng isang listahan ng pamimili.

## Mga Gawain sa Paghahanda ng Pamamahagi ng Pagkain

- ♥ Turuan ang iyong pamilya kung paano mamili sa mga groserya.
- ♥ Isama ang mga bata at ibang mga miyembro ng iyong pamilya sa paghahanda ng mga pagkain at paglilinis.
- ♥ Maglinis habang nagluluto—konti ang iyong lilinisan pagkatapos mong magluto.
- ♥ Ibahagi ang mga tungkulin sa pagluluto sa ibang mga miyembro ng pamilya o mga kapitbahay. Halimbawa, ang iyong pamilya ay maaaring magluto ng sapat na pagkain upang maibahagi sa ibang pamilya.

## Magluto ng mas Maaga

- ♥ Maghanda ng ilang mga pagkain ng mas maaga, tulad ng sarsa ng *spaghetti*. Gamitin ang mga pagkaing ito para sa mabilisang mga pagkain. Maaari kang magdagdag ng manok o baka sa sarsa at ihain ito sa spaghetti o sa kanin.
- ♥ Ihanda kinagabihan ang mga bahagi ng isang pagkain (halimbawa, ibabad ang manok nang magdamag sa *refrigerator*).
- ♥ Balutin kinagabihan ang iyong tanghalian.
- ♥ Hiwain at hugasan ang mga gulay, at gumawa ng sapat na ensalada para sa 2 araw. Huwag magdagdag ng *dressing* hanggang sa oras ng paghahain.
- ♥ Magluto ng dalawa o tatlong putahe sa araw na wala kang pasok, ilagay sa *freezer* ang ilan sa mga ito. Gamitin ang naka-freeze na mga putahe sa mga araw na wala kang oras na magluto.
- ♥ Maghanda kinagabihan ng mga *recipe* sa pamamagitan ng paghihiwa at pagbabawas ng mga karne.
- ♥ Ihanda ang mga pagkain sa isang mabagal na pagluluto.

# Mga Payo para sa Mga Pamilya na Abala *(continued)*



## Magluto ng Simple

- ♥ Pausukan ang mga gulay at ihain ito ng walang mga sarsa.
- ♥ Gumamit ng mga naka-freeze na gulay na walang mga sarsa.
- ♥ Pakuluan, pausukan, ihawin, ihurno, o ilitson ang mga karne.
- ♥ Gumawa ng isang kalderong mga pagkain, tulad ng mga *stew* at *casserole*.
- ♥ Gumamit ng naka-freeze na tinilad-tilad na mga gulay, tulad ng mga *carrot*, *pea*, at *broccoli*.
- ♥ Gamitin ang *microwave* para sa pagluluto o pagde-defrost.
- ♥ Matuto ng mga simpleng *recipe* na maaaring gawin na mas mababa sa 30 minuto.

## Gumamit ng Mga *Herb* at Pampalasa

- ♥ Ihawain ang mga sariwang *herb*, at ilagay sa mga *trey* ng yelo. Punuin ng tubig ang mga *trey*, at i-freeze. Iimbak ang mga yelo sa isang *plastic bag*. Gamitin kapag kinakailangan mo ng mga sariwang *herb*.
- ♥ Mag-alaga ng mga dahon ng *laurel*, *basil*, o *thyme* sa isang naaarawang bintana.
- ♥ Palaging magtabi ng mga tuyong *herb*. Ang isang kutsarita ng mga tuyong *herb* ay katumbas ng 3 kutsarita ng mga sariwang *herb*.

## Laging Magtabi ng Mga Madaliang Minindal

- ♥ Subukan ang mga malusog na minindal na ito:
  - Mga sariwang prutas at gulay
  - Buong butil, handa kainin, tuyong *cereal*
  - Polvorones (buong *wheat* na kendi)
  - *Fat-free* at *low-fat* na keso
  - Mga maning walang asin, buto, at biskwit
  - Mga buong butil na tinapay

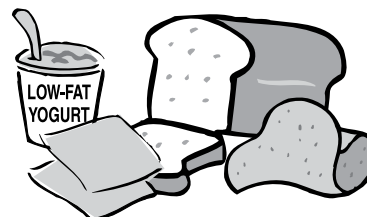

# Rose's Busy Schedule

Rose has a busy life. She has three young children, and she and her husband both work Monday through Friday. Rose's husband Jose leaves for work at 5:30 a.m. and gets home at 7:30 p.m. Rose usually leaves for the office at 9 a.m. and gets home around 6 p.m. Every night, after she comes home from work, Rose gets the family's dinner ready. Rose wants the family to be heart healthy, but she never seems to have the time to cook. Often, she is running late or is too tired to cook, so she picks up pizza, Chinese food, or fried chicken on her way home.

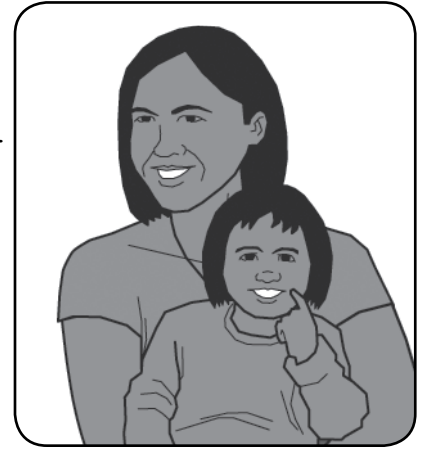

Since his stroke, Jose wants her to make healthier, traditional Filipino dinners. Rose tries to get her husband to help her with dinner, but he is always tired. Besides, Jose does not like cooking. They also have to help the children with their homework. This leaves them little time to prepare heart healthy meals.

**What can Rose do to make sure that her family eats in a heart healthy way?**  
Write down some ideas for Rose to try:

---

---

---

---

---

---

---

---

---

---

---

---

---

---

---

---

---

---

---

---

---

---

---

---



# Lola's Tips for Heart Healthy Chinese Food

Here are Lola Idad's tips for lowering fat and calories when you order food from a Chinese carryout restaurant.

<b>Choose More Often</b>	<b>Choose Less Often</b>
<ul style="list-style-type: none"> <li>• Steamed or grilled dishes, such as steamed dumplings or grilled fish, instead of fried dishes.</li> <li>• More vegetable dishes or dishes that have large amounts of vegetables, such as beef with broccoli.</li> <li>• Steamed rice instead of fried rice. (Steamed rice is lower in fat, cholesterol, and calories.)</li> </ul>	<ul style="list-style-type: none"> <li>• Deep-fried dishes such as Kung Pao Chicken, General Tso's Chicken, Mu Shu Pork, or fried egg rolls.</li> <li>• Fried rice.</li> <li>• Dishes with heavy sauces, such as coconut milk.</li> </ul>
<b>AND . . . .</b>	
<ul style="list-style-type: none"> <li>• Let the restaurant know your dietary needs, so they can suggest ways to meet your needs, if possible.</li> <li>• On the day you are planning to order Chinese food, eat foods with less sodium in your other meals and snacks. Many dishes from Chinese restaurants are very high in sodium.</li> <li>• You can cut down on the sodium in the Chinese food you order. Make sure the restaurant does not use monosodium glutamate (MSG) in the dishes. MSG is high in sodium!</li> <li>• You can also cut down on sodium by using light soy sauce to season the food.</li> <li>• Instead of buffets, order healthy choices from the menu.</li> </ul>	

Source: Adapted from Asian Health Services, [www.ahschc.org](http://www.ahschc.org).

# Mga Payo ni Lola para sa Malusog sa Pusong Pagkain ng Tsinos

Narito ang mga payo ni Lola Idad para sa pagpapababa ng taba at calorie kapag umorder ka ng pagkain mula sa isang restawran na *Chinese carryout*.

Piliin nang Mas Madalas	Piliin nang Hindi Madalas
<ul style="list-style-type: none"> <li>♥ Pinausukan o inihaw na mga pagkain, tulad ng mga pinausukang <i>dumpling</i> o inihaw na isda, sa halip na mga piniritong pagkain</li> <li>♥ Mas maraming mga pagkaing gulay o mga pagkain na mayroong maraming mga gulay, tulad ng baka na may <i>broccoli</i></li> <li>♥ Sinaing na kanin sa halip na sinangag (ang sinaing na kanin ay mas mababa sa taba, kolesterol, at mga calorie)</li> </ul>	<ul style="list-style-type: none"> <li>♥ Mga pagkaing piniritong nakalubog sa mantika tulad ng <i>Kung Pao Chicken</i>, <i>General Tso's Chicken</i>, <i>Mu Shu Pork</i>, o piniritong <i>egg rolls</i></li> <li>♥ Sinangag</li> <li>♥ Mga pagkaing masarsa, tulad ng gata</li> </ul>
<p><b>AT . . .</b></p>	
<ul style="list-style-type: none"> <li>♥ Ipaalam sa restawran ang iyong mga pangangailangang pandiyeta, upang makakapagmungkahi sila ng mga paraan upang maabot ang iyong mga pangangailangan, kung posible.</li> <li>♥ Sa araw na pinaplano mong umorder ng pagkaing Tsino, Kumain ng mga pagkain na kaunti ang asin sa iyong iba pang mga pagkain at meryenda. Maraming mga pagkain mula sa mga restawrang Tsino ay napakataas sa asin.</li> <li>♥ Maaaring mong bawasan ang asin sa pagkaing Tsino na inorder mo. Tiyakin na ang restawran ay hindi gumagamit ng <i>monosodium glutamate (MSG)</i> sa mga pagkain. Ang <i>MSG</i> ay mataas sa asin!</li> <li>♥ Maaari mo ring bawasan ang asin sa pamamagitan ng paggamit ng <i>light</i> na toyo upang matimplahan ang mga pagkain.</li> </ul>	

Pinagkunan: Kinuha mula sa Asian Health Services, [www.ahschc.org](http://www.ahschc.org).

# Tips for Eating Out the Heart Healthy Way

**You do not have to give up eating fast foods to eat right.**

**Here are some tips on how to make heart healthy choices at fast food restaurants.**

## Sandwiches

- ♥ Order sandwiches without mayonnaise, tartar sauce, or special sauces. Or, try mustard or low-fat mayonnaise. Ask for vegetables to be added to your sandwich.
- ♥ Order small, plain hamburgers instead of deluxe sandwiches.
- ♥ Order sandwiches made with lean roast beef or grilled chicken. Chicken and tuna salad made with regular mayonnaise are high in fat.
- ♥ Choose grilled chicken or fish sandwiches instead of breaded chicken or fish sandwiches.

## Main dishes

- ♥ Choose rotisserie-style chicken rather than fried chicken. Always remove the skin.
- ♥ Order pizza with vegetable toppings, such as peppers, mushrooms, or onions. Ask for half the usual amount of cheese.
- ♥ Choose grilled, broiled, steamed, or baked fish instead of fried fish.
- ♥ Leave off sauces.



## Side dishes

- ♥ Share a small order of french fries instead of eating a large order by yourself.
- ♥ Ask that no salt be added to your serving.
- ♥ Order a baked potato instead of french fries.
  - Try vegetables as a potato topping.
  - Ask that high-fat toppings, such as cheese or sour cream, be served on the side, and use fewer toppings.
  - Ask for low-fat cheese and low-fat sour cream.
- ♥ Use low-calorie, low-fat salad dressing on salad. Bring your own if the restaurant does not offer a low-fat dressing. You can buy packets at some stores. Ask that dressings be served on the side, and use less.
- ♥ Order a green vegetable or salad instead of two or more starches, such as potatoes, steamed rice, noodles (pasta), bread, and corn.



## Beverages

- ♥ Choose water, 100% fruit juice, unsweetened iced tea, or fat-free or low-fat (1%) milk, rather than a soft drink or a milkshake.
- ♥ If you really want to have a soft drink, order a small one or a diet soda.



## Desserts

- ♥ Buy fresh fruits and gelatin instead of cakes or pies.

# Mga Payo sa Pagkain sa Paraang Malusog sa Puso

---

Hindi mo kailangan isuko ang pagkain sa mga *fast food* upang kumain ng tama.

Narito ang ilang mga payo kung paano gumawa ng mga pagpipilian malusog sa puso sa mga *fast food* na restawran.

## Mga Sandwich

---

- ♥ Umorder ng mga *sandwich* na walang *mayonnaise*, *tartar sauce*, o mga espesyal na sawsawan. O, subukan ang *mustard* o *low-fat mayonnaise*. Humingi ng mga gulay na idadagdag sa iyong *sandwich*.
- ♥ Umorder ng maliit, mga *hamburger* na walang sahog sa halip na mga *deluxe sandwich*.
- ♥ Umorder ng mga *sandwich* na gawa sa walang taba na nilitson na baka o inihaw na manok. Manok at *tuna salad* na ginawa na may *regular mayonnaise* ay mataas sa *fat*.
- ♥ Piliin ang inihaw na manok o mga fish sandwich sa halip na manok na may breading o mga fish sandwich.

## Pangunahing mga putahe

---

- ♥ Piliin ang manok na *rotisserie-style* kaysa sa pritong manok. Laging alisin ang balat.
- ♥ Umorder ng *pizza* na may mga sahog na gulay, tulad ng mga *pepper*, kabute, o sibuyas. Hilingin para sa kalahati para sa karaniwang dami ng keso.
- ♥ Piliin ang inihaw, nilitson, pinausukan, o hinurnong isda sa halip na pritong isda.
- ♥ Umiwas sa mga sarsa.



## Mga side dish

---

- ♥ Mamahagi ng isang maliit na order ng *french fries* sa halip ng pagkain ng isang malaking order sa pamamagitan ng iyong sarili.
- ♥ Hilingin na huwag dagdagan ng asin ang iyong takal.



# Mga Payo sa Pagkain sa Paraang Malusog sa Puso *(continued)*

---

- ♥ Umorder ng isang hinurnong patatas sa halip na piniritong patatas.
  - Subukan ang mga gulay bilang isang *topping* na patatas.
  - Hilingin na ang mga *high-fat* na *topping*, tulad ng keso o *sour cream*, na maihain sa gilid, at gumamit ng mas kaunting mga *topping*.
  - Humiling ng kesong *low-fat* at *low-fat* na *sour cream*.
- ♥ Gumamit ng *low-calorie, low-fat salad dressing* sa *salad*. Magdala ng iyong sariling *low-fat dressing* kung ang restawran ay hindi nag-aalok nito. Maaari kang bumili ng mga naka-pakete sa ilang mga tindahan. Humiling ng mga *dressing* na ihahain sa gilid, at gumamit ng kaunti.
- ♥ Umorder ng isang berdeng gulay o *salad* sa halip ng dalawa o higit pang mga *starch* tulad ng mga patatas, sinaing na kanin, *noodles (pasta)*, tinapay, at mais.

## Mga Inumin

---

- ♥ Pumili ng tubig, 100-porsyento na katas ng prutas, *unsweetened iced tea*, o *fat-free* o *low-fat* (1%) na gatas kaysa sa isang *soft drink* o isang *milkshake*.
- ♥ Kung gusto mo talagang uminom ng *soft drink*, umorder ng isang maliit na bahagi o isang *diet* na *soda*.

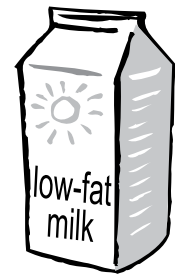

## Mga Panghimagas

---

- ♥ Bumili ng mga sariwang mga prutas at *gelatin* sa halip na mga *cake* o *pie*.

# *(Optional)* Eating Out With the de la Cruz Family Role Play

---

Ric has just arrived at his favorite Chinese restaurant buffet for a dinner with his mother, Lola Idad, and the family of his brother Cesar.

**Cesar:** This is a good restaurant. They have good food for good prices.

**Ric:** Eating at buffets is hard for me. I have been trying to eat healthy ever since the doctor told me that I have high blood pressure. But when I see and smell the food here, I want to try it all. It takes a lot of will power not to choose the fried foods, which have always been my favorite!

**Cesar:** Remember the advice that Jose gave you—choose the right foods, whether you are eating at home or eating out.

**Lola:** That’s right, Cesar. We can all make heart healthy choices, even when we eat out. Remember, “*Kung may itinanim, may aanihin.*” “If you plant, you will harvest.” If you follow a healthy lifestyle, you will improve your health. Make wiser choices and eat smaller portions, and you can lower your blood pressure and lose some weight—like I did!

**Cesar:** Ric, I am going to eat the steamed dumplings, vegetables, and rice with the baked fish. And I am only going to make one trip to the buffet table so I don’t eat too much.

**Ric:** That sounds like a good dinner. Cesar, let’s go to the buffet table together. I will follow your lead.

# Money-Saving Tips

---

**You can save money on groceries. Follow these simple suggestions.**

## Before Going to the Store

---

- ♥ Plan weekly meals. Your family can help you plan the menu.
- ♥ Make a shopping list based on your meal plan.
- ♥ Check the food sale ads.
- ♥ Use coupons. Check the Sunday newspaper, and clip coupons for foods you normally buy or need. Ask your children or another family member to help you. Remember—coupons do not save you money if you buy products that you do not need. Always compare the price of the item using the coupon with the price of other items on the shelf.
- ♥ Make fresh foods at home instead of using prepared items such as frozen entrees, bakery cakes, or salads.



## Choosing a Store

---

- ♥ Shop at the store that has the lowest prices for the items you need. That may be a different store every week.
- ♥ Remember that convenience stores tend to have higher prices and less variety than supermarkets.

## At the Store

---

- ♥ Buy what is on your list. You are more likely to buy too much or buy items that you do not need when you do not use a list.
- ♥ Convenience can cost more. Some examples include:
  - Canned beans are high in sodium
  - Boneless chicken breasts
  - Precut vegetables
- ♥ Buy fruits and vegetables that are in season.
- ♥ Buy only the amount of food your family can use, even if a larger size costs less.
- ♥ Shop alone when possible. Family members or friends may try to get you to buy items you do not need.
- ♥ Do not shop when you are hungry.
- ♥ Watch for errors at the cash register. Sometimes sale items do not ring up on sale. Some stores give customers free items if they are charged the wrong amount.



# Shopping List

**Make a shopping list. Include the items you need for your menus and any basics you need to restock in your kitchen.**

## Produce

- Fresh fruits (bananas, apples, oranges, mangoes, pineapple, papaya, grapes)
- Fresh vegetables (cabbage, bok choy, green onions, spinach, broccoli, carrots, green onions, sweet potatoes, peppers)
- Garlic

## Whole-Grain Breads, Muffins, and Rolls

- Bread, bagels
- English muffins
- Pan de sal*
- Dinner rolls
- \_\_\_\_\_
- \_\_\_\_\_
- \_\_\_\_\_

## Cereals, Rice, Crackers, and Noodles

- Steamed rice
- Noodles (pasta)
- Cereal, dry or cooked
- Other \_\_\_\_\_
- Soda crackers\*
- Graham crackers
- Other crackers\*
- \_\_\_\_\_
- \_\_\_\_\_
- \_\_\_\_\_



## Milk Products†

- Fat-free or low-fat (1%) milk
- Fat-free or low-fat (1%) cottage cheese
- Fat-free or low-fat cheeses
- Fat-free or low-fat yogurt
- Light or diet tub margarine
- Fat-free sour cream
- Fat-free cream cheese
- Eggs

## Meats, Poultry, Fish, and Seafood

- Chicken 
- Fish (milkfish, grouper, mackerel)
- Seafood (shrimp, mussels, clams, crab, squid)
- Beef (round or sirloin)
- Extra-lean ground beef
- Pork tenderloin, leg, shoulder
- Lower-fat lunch meats (chicken, lean roast beef)\*
- Tofu
- Dry beans and peas
- Unsalted roasted nuts
- Peanut butter\*

## Baking Items

- Flour
- Sugar
- Vegetable oil spray 
- Fat-free canned evaporated milk
- Fat-free dry milk powder
- Unsweetened cocoa powder
- Baking powder

## Canned Fruits, Vegetables, Beans, and Soups

- Canned fruit in juice
- Applesauce
- Canned tomatoes (no salt added)
- Low-sodium tomato sauce or paste
- Other canned vegetables (no salt added)
- Canned broth (fat-free, low-sodium)\*
- Other canned soups\*
- Canned beans or peas (no salt or seasoning added)
- \_\_\_\_\_
- \_\_\_\_\_

## Fats and Oils

- Margarine (liquid, tub, or diet)\*
- Unsaturated vegetable oil

## Frozen

- Fat-free or low-fat frozen yogurt and desserts\*
- Frozen vegetables without sauces
- Frozen fruit juices

## Other

- Herbs and spices (anise, basil, bay leaf, lemongrass, oregano, parsley, saffron, sage) 
- Vinegar
- Light soy sauce (low sodium)

\* Use the Nutrition Facts label to choose foods lowest in saturated fat, *trans* fat, cholesterol, sodium, and calories.

† Or lactose-free milk and milk products, such as low-fat or fat-free soy milk.



# What \$10 Can Buy

Healthy foods do not have to be expensive! Compare these two shopping lists. Which list has healthier food choices? Which list has the best buys?

List #1	
Food	Cost*
1 large bag (20 oz.) potato chips	\$ 4.19
2-liter bottle, cola	\$ 1.49
1 small bag (2.5 oz.) beef jerky	\$ 2.19
1 <i>ensaymada</i> (sweet bread)	\$ 1.50
1 chocolate candy bar	\$ 0.65
<b>Total Cost</b>	<b>\$10.02*</b>

List #2	
Food	Cost*
5 bananas	\$ 1.00
½ pound (0.23 kg) grapes	\$ 1.50
2 red apples	\$ 1.69
1 pound (0.45 kg) bag carrots	\$ 1.00
1 orange	\$ 0.69
1 cucumber	\$ 0.60
2 6-ounce containers low-fat yogurt	\$ 2.00
1 gallon spring water	\$ 1.00
<b>Total Cost</b>	<b>\$ 9.48*</b>

**Make smart choices: Save money, and eat heart healthy!**

\* Costs based on prices in the metropolitan Washington, DC, area.

Source: Adapted from the HHS Office on Women's Health, U.S. Department of Health and Human Services, BodyWorks Toolkit.

# Vegetable *Kare-Kare* (Peanut Stew) Recipe

9 ounces (250 grams)	gluten or seitan,* cubes	<ol style="list-style-type: none"> <li>1. Saute gluten cubes in corn oil. Add garlic and onions.</li> <li>2. Pour enough water to cover gluten, and add ground peanuts and ground rice to thicken.</li> <li>3. Add <i>atsuete</i> for coloring, and season with salt.</li> <li>4. Add the eggplant, then string beans, then banana, then bok choy (<i>pechay</i>).</li> <li>5. Place on top of the cooked gluten.</li> </ol>
1	onion, medium, sliced	
2 cloves	garlic, crushed	
2 tablespoons	corn oil	
½ cup	ground peanuts	
¼ cup	ground toasted rice†	
¼ teaspoon	salt	
3.5 ounces (100 grams)	string beans, sliced	
7 ounces (200 grams)	eggplant, sliced	
5 ounces (150 grams)	banana heart or bud	
3.5 ounces (100 grams)	bok choy ( <i>pechay</i> ), sliced	

\* Gluten is made from protein that is in a variety of grains, such as wheat and rye, and is mixed with water and kneaded. A form of wheat gluten, seitan, goes through the process and is sold as strips or in cans at health food stores and Asian supermarkets.

† To make ground, toasted rice: Place rice, ½ cup at a time, in a frying pan or wok and heat over moderate heat, stirring frequently to keep it from burning and to allow it to develop a uniform, deep golden color—2 to 3 minutes. Then remove it from heat and cool to room temperature. Grind the toasted rice coarsely—not finely grounded—in a blender, or spice or coffee grinder.

## Quick Facts

This version of vegetable *kare-kare* is healthier than the traditional Filipino dish because:

- It does not contain cholesterol because it uses the protein product gluten instead of oxtails or other meat.
- It includes a lot of vegetables and fruit.
- The rich, nutty sauce has only a small amount of sodium.

Yield:	Serving size
<b>6 servings</b>	
Calories	300 kcal
Total Fat	12 g
Saturated Fat	1.5 g
Cholesterol	0 mg
Sodium	125 mg
Total Fiber	4 g
Protein	36 g
Carbohydrates	20 g
Potassium	320 mg

Source: *PHC Alive Diet*, Division of Nutrition and Dietetics, Philippine Heart Center, East Avenue, Quezon City, Philippines, page 91.

# Lola's Life Lessons: Session 9

---

One of my favorite proverbs is:

*“Ang taong matalino ay hindi tumitingin sa pagyapak ng paa niya sa lupa.  
Binabantayan niya ang kanyang kasunod na hakbang.”*

Translation: “A wise man does not see his foot on the ground; he watches his next step.”

Your future includes balancing your health, your time, and your money. Be wise in your future choices. When I learned that I have high blood pressure, your Lola had to make changes in her lifestyle to lower her blood pressure and to keep good heart health. Heart healthy eating is possible on a busy schedule and on a budget, but you need to be wise and plan ahead.

Look at Rose. With help from Mila, she has learned to be heart smart about cooking. Rose now prepares dishes on the weekends and stores them in the freezer. She uses a list to go shopping and plans her family's meals ahead of time. This helps her know what to buy at the grocery store. Rose also has been buying fewer foods that are high in fat and sodium, and her family is not eating out as often. Sometimes, Mila and I will cook extra food to share with Rose to make sure the family stays heart healthy.

To make it work, you have to think ahead. Keep your heart and family in mind when planning the family's meals and when planning the next step.

## **A Time To Reflect...**

When there is little time or money, what can you do to keep your family heart healthy?

(Use this space to write down your thoughts for this week's session.)

# Pledge for Life! Session 9

---

Take the pledge for life with Lola Idad. Try to do one of these activities by yourself and/or share with others.

- Use a slow cooker (Crock-Pot<sup>®</sup>) for quick and easy cooking.
- Cook several dishes at one time, and freeze part of them.
- Order smaller portion sizes instead of larger portion sizes.
- Choose heart healthy foods and smaller portion sizes if you choose to eat at a buffet.
- Choose prepared foods at the grocery store less often.
- If the serving size is too big at the restaurant, bring home leftovers.
- Choose baked, steamed, broiled, or grilled dishes instead of fried.
- Order less meat and more vegetable dishes.
- Try not to shop at convenience stores.
- Go to the market when you are **not** hungry.
- Plan weekly meals, and shop with a list.
- Try a store-brand product to save money.
- Other \_\_\_\_\_



# Take Control of Your Health: Enjoy Living Smoke Free

---

## Objectives

**By the end of this session, group members will learn:**

- How cigarette smoking harms smokers
  - How secondhand smoke harms people who are near smokers
  - Tips that can help smokers who want to quit
  - Ways to ask people not to smoke around you
- 

## Materials and Supplies

**To conduct this session, you will need:**

- “Healthy Heart, Healthy Family” manual and picture cards
  - Blackboard and chalk or several large pieces of paper, markers, and tape
- 

## Handouts

**Give group members these handouts during the session:**

- List of places where smoking cessation programs are offered\*

---

\* Prepare this list before the session. You may find information at your local health department, hospital, or a clinic.

- (Optional) “A Smoke-Free Life Role Play” (page 381)
- “Smoking Harms You” (page 382)
- “Smoking Harms Infants and Children” (page 383)
- “Costs of Smoking” (page 384)
- “Role Play: Someone Is Smoking. What Can You Do?” (pages 385–387)
- “Smoke-Free Family Sign” (pages 388–389)
- “Tips To Quit Smoking” (pages 390–393)
- “Help Your Heart—Don’t Smoke” (page 394)
- “Break Free From the Smoking Habit” (pages 395–397)
- “Lola’s Life Lessons” (page 398)
- “Pledge for Life!” (page 399)



**Note:** Posters and other materials may be ordered from the following organizations:

- National Cancer Institute—1-800-4-CANCER (1-800-422-6237) or [www.cancer.gov/](http://www.cancer.gov/)
- American Lung Association—1-800-LUNGUSA (1-800-586-4872) or [www.lungusa.org](http://www.lungusa.org)
- American Cancer Society—1-800-ACS-2345 (1-800-227-2345) or [www.cancer.org](http://www.cancer.org)
- American Heart Association—1-800-AHA-USA-1 (1-800-242-8721) or [www.americanheart.org](http://www.americanheart.org)

---

## **Session Outline**

### **Introducing the Session**

1. Welcome
2. Review of Last Week's Session
3. About This Session

### **Conducting the Session**

1. *(Optional)* "A Smoke-Free Life" Role Play
2. Facts About Smoking
3. Smoking Harms Infants and Children
4. Youth and Smoking
5. Smoking and Your Wallet
6. Secondhand Smoke
  - A. Secondhand Smoke Can Harm You and Those Around You
  - B. Secondhand Smoke Role-Playing Activity
7. Quitting Smoking

### **Review of Today's Key Points**

### **Lola's Life Lessons: A Time To Reflect**

### **Pledge for Life!**

### **Closing**



# Introducing the Session

---

## 1. Welcome

- Welcome group members to the session.

## 2. Review of Last Week's Session

- Say:

At the last session, we talked about ways to save money on our food bills. Who can name some of them?



**Note:** Write group members' ideas on the blackboard or on a large piece of paper taped to the wall.

- Add these ideas if they are not mentioned:

- Plan weekly meals, and shop with a list.
- Clip coupons for products you use.
- Check the food sale ads.
- Use fewer prepared foods.
- Buy only the amount of food your family needs.
- Shop alone, when possible.
- Try not to shop when you are hungry.
- Check your receipt for errors at the register.
- Shop at convenience stores less often.
- Use store brands as often as possible.

■ **Ask:**

How are you doing with your pledges to eat in a heart healthy way even when time or money is tight? What went well? Did you have problems? If so, what did you do to solve them?



**Note:** Allow 5 to 8 minutes for group members to respond.

### **3. About This Session**

■ **Say:**

This session is about the importance of not starting to smoke and quitting smoking. During this session, you will learn:

- How cigarette smoking harms smokers
- How secondhand smoke can harm you or those around you
- Ways to ask people not to smoke around you
- Tips to quit smoking (for you and others)

■ **Say:**

This session is about the dangers of smoking to heart health. Lola Idad knows the dangers of smoking well. She saw her husband struggle with his smoking habit until his last days. Lola often reflects on the Visayan proverb, “*Walang tagumpay, kung walang paghihirap.*” “There is no success if there is no sacrifice.”

■ **Ask:**

- How many of you smoke?
- How many of you live with a smoker?
- How many of you would like to live smoke free?

■ **Say:**

Tobacco is used in a variety of ways—in cigarettes, cigars, pipes, and chewing tobacco. This session focuses on cigarette smoking, because it’s the most common use of tobacco.



**Note:** Other names for cigarettes include “yosi,” “smokes,” “cigs,” and “butts.”

## Conducting the Session

### 1. (Optional) “A Smoke-Free Life” Role Play

- Give each group member the “A Smoke-Free Life Role Play” handout (page 381). Ask for two volunteers to be actors for the role play. Select a third volunteer to be the narrator.

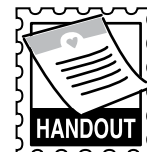

**Note:** Allow 5 minutes for open discussion.

■ **Ask:**

- What are some of the lessons we learned from this role play?
- Is there any part of the play that you can use in your own life?

### 2. Facts About Smoking

■ **Say:**

About 15 percent of Filipino adults and 7 percent of Filipino adolescents (age 12 to 17 years) in the United States smoke cigarettes.

■ **Say:**

There are many reasons why you should quit smoking or not start smoking. Let's go over these reasons:

- In the United States, about 440,000 people die each year from diseases related to smoking. This is more than 1,200 people each day. Smoking causes about one in every five deaths.
- Health care costs due to smoking are about \$75 billion each year in the United States.

- Smokers use tobacco regularly because they become addicted to nicotine, which is a powerful drug. Nicotine is found in all tobacco products. Most cigarettes contain 10 milligrams (mg) or more of nicotine. By inhaling the smoke, the average smoker takes in 1 to 2 milligrams of nicotine per cigarette.
- Smoking can harm those around you! Cigarette smoking puts the health of your family, children, and friends at risk.

■ **Show picture card 10.1.**

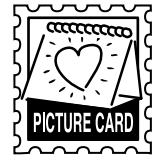

■ **Say:**

Today, we are going to talk about what can happen when you smoke. We also are going to talk about ways to stop smoking and ways to support a friend or family member who wants to quit.

- **Give** group members the “Smoking Harms You” handout (page 382), and review the information.



 **Note:** Ask for volunteers to read the handout aloud. Keep the picture card on display while you review this handout.

### 3. Smoking Harms Infants and Children

- **Show picture card 10.2.**

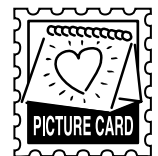

■ **Ask:**

Do you think it is all right for pregnant women to smoke?

 **Note:** Allow a moment for group members to respond.

■ **Say:**

Pregnant women should not smoke, because it will affect their babies’ health and well-being. They should also stay away from others who smoke, because of the harm that secondhand smoke causes.

■ **Say:**

Let’s go over some problems that can arise when pregnant women smoke.

- Give group members the “Smoking Harms Infants and Children” handout (page 383).



**Note:** Ask for volunteers to read the handout aloud, or you can cut out the facts, following the dotted lines on the handout, and put them in a box. Let group members **draw** slips of paper and read the facts aloud. **Keep picture card 10.2** on display while you review the handout.

## 4. Youth and Smoking

- Show picture card 10.3.

- Ask:

Why do you think many people begin smoking as teenagers?

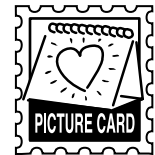

**Note:** Review the picture card to show the reasons that teens smoke.

- Add the following reasons if they are not mentioned:

- Teens want to be like their friends.
- Young people smoke to try to look older.
- Some teens want to be like celebrities who smoke in movies or on television.
- Some teens are influenced by advertisements that make smoking look “cool” or glamorous.
- Some teens may want to be like their parents or other family members who smoke.
- Some teens will smoke just to do something their parents don’t want them to do.
- Young people downplay the harm smoking can do, or they think they will not be harmed.
- Teens may like the jackets, hats, and other prizes that tobacco companies offer.

■ **Say:**

Let's look at some of the facts about young people and smoking.

- Each day about 2,000 young people under age 18 become regular smokers. That's nearly 750,000 teens per year. If this continues, more than 6 million young people who are regular smokers could die from a tobacco-related disease.
- Young people who use tobacco may find it hard to play sports. Smoking causes shortness of breath and dizziness. Chewing tobacco causes dehydration.
- Use of spit tobacco can cause cracked lips, white spots, sores, and bleeding in the mouth.
- People who start smoking at a young age are likely to smoke all their lives.
- The longer a person smokes, the more likely he or she will develop the problems caused by smoking.
- Young people who smoke cigarettes are also more likely to try other drugs, especially marijuana.
- It is illegal in all states to sell cigarettes and other tobacco products to persons under age 18.

■ **Say:**

Let your children know that most teens do not smoke. Tell your children that most teens who do smoke say they wish they had never started.

■ **Say:**

If you smoke, set an example for your family by quitting. Be honest. Admit that you are having trouble kicking the habit. Let young people know that it is best

not to start smoking, rather than trying to quit later. Try not to smoke in front of your children. Never ask your children to bring you cigarettes or to light a cigarette. Asking them to do those things can send the message that smoking is okay for them to do.

## 5. Smoking and Your Wallet

### ■ Say:

Smoking costs a lot in other ways. Let's look at some things a smoker could buy with the money that he or she spends on cigarettes.

- Give out and review the "Costs of Smoking" handout (page 384).



## 6. Secondhand Smoke

### A. Secondhand Smoke Can Harm You and Those Around You

#### ■ Ask:

What have you heard about secondhand smoke?



**Note:** Allow 3 to 5 minutes for group members to respond.

#### ■ Say:

Secondhand smoke is the smoke that you breathe in from someone else's cigarette or cigar. Even nonsmokers can be harmed if they are near secondhand smoke.

#### ■ Say:

Let's take a look at some facts about secondhand smoke.

- Secondhand smoke contains poisons, such as arsenic, cyanide, ammonia, and formaldehyde.

- Breathing secondhand smoke may cause eye irritation, nose and throat discomfort, headaches, and coughing.
- Nonsmokers exposed to secondhand smoke increase the risk of developing heart disease by 25 to 30 percent.
- Secondhand smoke causes nearly 1 in 10 smoking-related deaths.
- Each year, about 3,000 nonsmokers die of lung cancer caused by secondhand smoke.
- Infants and children who live with someone who smokes are twice as likely to have respiratory illness, bronchitis, and pneumonia as are children who do not live with someone who smokes.
- Secondhand smoke can bring on an asthma attack.

## B. Secondhand Smoke Role-Playing Activity



### ■ Say:

Let's try role playing. Some people have a hard time telling smokers not to smoke around them or their children. This activity will let you practice what to say when someone smokes around you or your family.

- **Divide** group members into groups of three. **Give** each group a scene from the role-play handouts on pages 385–387 to act out. **Ask** them to act out a solution to the problem, too.



**Note:** **Read** the scenes one at a time, or **hand out** copies to each group. Allow about 5 minutes for each group to role-play a solution.



## Scenes for Role-Playing Activity: Someone Is Smoking. What Can You Do?

---

### ■ Scene 1

Your brother-in-law's friend comes to your home for a dinner party. Most of the family and guests are in the living room talking. Your brother-in-law's friend comes to the kitchen to ask you for an ashtray, as he lights up his cigarette. You know smoking around the children is harmful. What can you do?

#### **Solutions:**

- Tell him that cigarette smoke is harmful to you and your children.
  - Ask him if he would please go outside to smoke.
  - Tell him your home is smoke free.
  - Tell family members and friends ahead of time that you do not allow smoking inside your house.
  - Post a "Thank You for Not Smoking" sign for visitors.
- 

### ■ Scene 2

You go out to eat with a friend to celebrate a special occasion. You ask to sit in the nonsmoking section of the restaurant. The nonsmoking area is in a corner of the restaurant. There are no walls separating the smoking section from the nonsmoking section. As you order your meal, four people sit down about three tables away from you in the smoking section. They begin to smoke one cigarette after another. After a minute or two, you begin to smell their smoke at your table. You tell the waiter the smoke is bothering you. He says he cannot ask them to stop because they are in the smoking section. What do you do?

#### **Solutions:**

- Ask to be moved to another table farther from the smokers.
  - Ask the waiter to wrap up your food and leave.
  - Tell the manager that you cannot be around smokers.
- 

### ■ Scene 3

Your teenager comes home after school smelling like smoke. What do you do?

#### **Solutions:**

- Do not jump to conclusions. First, ask the teen if he or she was smoking cigarettes.
- If so, ask the teen why and how long he or she has been smoking.
- Encourage your teen to quit by explaining the dangers of smoking.
- Give examples of family members and friends who have quit or have gotten sick from smoking.
- If your teen was not smoking and says that it is the friends who smoke, compliment and encourage him or her to continue to say no to smoking.
- Update your teen on the risks of secondhand smoke.

- **Ask** group members if they have any comments or questions about the role play.

- **Say:**

One thing we all can do in our homes to prevent these situations is to post a sign that says “Thank You for Not Smoking” or “This Is a Smoke-Free Home.” This lets guests know your house is smoke free.

- **Give** group members the “Smoke-Free Family Sign” handout (pages 388–389).

- **Say:**

This sign can be used on a tabletop or taped to the wall or refrigerator.



## 7. Quitting Smoking

- **Say:**

Quitting smoking is not easy, but it can be done. To quit smoking for good, some smokers need help to overcome their urges to smoke. They also need encouragement and support to help them break the habit.

- **Say:**

In the Philippines, it is often said that “*Ang bawat sigarillo ay pako sa ataul mo.*” “Every cigarette stick is a nail in your coffin.”

- **Say:**

Have any of you quit smoking? Or do you know anyone who has quit smoking? What are the benefits of quitting smoking?



**Note:** Allow 3 to 5 minutes for group members to respond. **Write** their answers on the blackboard or on a large piece of paper taped to the wall.

■ **Add** the following answers if they are not mentioned:

- You will live longer and have better health.
- You will lower your chances of having a heart attack, stroke, cancer, or respiratory problems.
- If you are pregnant, quitting smoking will improve your chances of having a healthy baby.
- The people you live with, especially children and older adults, will be healthier.
- You will have extra money to spend on things other than cigarettes.
- You will be free of your morning cough.
- Your clothes, hair, and breath will smell better, as will your home and car.

■ **Say:**

To quit smoking, you need to know your personal feelings or the situations that trigger your urge to smoke. This will help you to overcome the urge to smoke.

■ **Ask:**

What are some of these feelings or situations that bring on the urge to smoke?



**Note:** Allow 3 to 5 minutes for group members to respond.

■ **Write** their answers on the blackboard or on a large piece of paper taped to the wall.

■ **Add** the following answers if they are not mentioned:

- Drinking coffee
- Drinking alcohol
- Talking on the phone
- Watching someone else smoke
- Feeling stressed

- Feeling bored
- Feeling depressed

■ **Say:**

Let's review what smokers can do to overcome the urge to smoke.

1. **Find ways to relax.** If stress causes you to want to smoke, try deep breathing to calm you. Let's try it now. Take a slow, deep breath, count to five, and release it.
2. **Keep busy.** Do activities that require the use of your hands, such as sewing, fishing, playing tennis, or doing arts and crafts, repair work, or a project around the house.
3. **Keep moving.** Try going for a walk, working in the garden, doing stretching exercises, or practicing your favorite dance steps.
4. **Know what to expect.** The nicotine in cigarettes and other tobacco products causes addiction. When smokers try to cut back or quit, the lack of nicotine in their bodies makes them have withdrawal symptoms. You may experience withdrawal symptoms. These symptoms are:
  - Headaches
  - Feeling irritable
  - Feeling tired
  - Having trouble concentrating

■ **Say:**

Although withdrawal symptoms are not pleasant, it is important to know that they are signs that your body is recovering from smoking. Most symptoms will go away in 2 to 4 weeks.

- **Give** group members the “Tips To Quit Smoking” handout (pages 390–393). **Ask** for volunteers to read the tips aloud.



■ **Say:**

These tips have helped other people. If you are a smoker, they can help you quit. If you're not a smoker, share the tips with a family member or friend who would like to quit. Studies have shown that these steps will help you quit smoking for good.

■ **Say:**

Nagging people about their smoking can make them become angry or defensive. Try these positive ways to help family members or friends who want to quit:

- Say things such as “Quitting is hard, but I know you can do it.”
- Help them stay away from smokers in the beginning, when it is the hardest to quit.
- Suggest other activities that will help them beat the urge to smoke. For example, ask them to take a walk with you.

■ **Ask:**

Do you have any questions about the information we covered today?

- **Give** group members the “Help Your Heart—Don’t Smoke” (page 394) and the “Break Free From the Smoking Habit” handouts (pages 395–397).



- **Ask** for volunteers to read the handouts out loud.

## More Information

- In the Philippines, as of January 1, 2007, it became illegal to advertise tobacco products on television and radio. As of 2008, all forms of advertising tobacco products in the mass media are prohibited.
- In the United States, tobacco companies spend billions of dollars advertising their products to get people to smoke. They do this through advertising in magazines, on billboards, and on posters in stores.
- One study in San Diego, CA, found that Asian American communities had more tobacco billboards than any other community, and Caucasian communities had the least.
- Tobacco ads usually show happy, attractive people enjoying life as they smoke their cigarettes. Many individuals want to be like those people, so they start smoking.
- Tobacco companies also advertise their products by supporting special sporting events such as tennis tournaments and car racing events. They go to dances, festivals, and other community events to promote their products by giving away free merchandise and cigarettes.
- Tobacco companies pay movie companies to have actors smoke on screen. This allows them to get around the law that bans cigarette advertising on television or in movie theaters.
- Tobacco companies attract new smokers to make up for the thousands of people who die each day of diseases related to cigarette smoking. They target young people because young smokers are likely to be lifelong smokers. Teenage smokers are important for the tobacco companies because teens will continue to buy cigarettes for many years.
- The advertising programs from tobacco companies influence young people. The number of youth who began smoking increased when tobacco companies introduced cartoon-like characters to sell cigarettes. Tobacco companies also give away gifts that appeal to youth to get them to smoke a certain brand.

# Review of Today's Key Points

## ■ Say:

Let's review what we learned today.

## ■ Ask these questions:

### **When people smoke, which diseases are they likely to develop?**

- Smoking contributes to heart disease, cancer, stroke, and respiratory diseases, such as chronic obstructive pulmonary disease and asthma.

### **Is it all right for pregnant women to smoke?**

- Pregnant women should not smoke. Smoking reduces the oxygen the baby receives, contributes to lower birth weight, and increases the chance of a baby being born dead.

### **What is secondhand smoke?**

- Secondhand smoke is smoke that you breathe in from someone else's cigarette. It is filled with harmful chemicals.

### **What can you do if someone is smoking around you and you don't like it?**

- Ask the person not to smoke inside, or leave the area yourself. Post a sign in your home that says "Thank You for Not Smoking" or "This Is a Smoke-Free Home."

# Lola's Life Lessons: A Time To Reflect

## ■ Say:

The de la Cruz family faces many challenges, from heart disease to smoking. This week, Lola Idad reminds us of the importance of hope on this journey. Lola and her family work hard to stay heart healthy and smoke free.

- Give each group member the “Lola’s Life Lessons: Session 10” handout (page 398). Ask a volunteer to read the handout.



- Say:

Please take a few moments to reflect on Lola’s advice and how it applies to your life. At the bottom of the handout, there is a space called “A Time To Reflect.” Use this section to record your feelings about this week’s session. Please write down your thoughts. Remember, this is for you and no one else.

- Give each group member 2 to 3 minutes to **write** down some thoughts.

## Pledge for Life!



- Say:

Pledge to do one thing to prevent or stop smoking or to reduce your exposure to secondhand smoke.

- Give group members the “Pledge for Life! Session 10” handout (page 399).



- Say:

We will talk about how you do with your smoking pledge at the next session. Also, keep working on the pledges you made during earlier sessions!

## Closing

- Say:

Thank you for coming today. What did you think of today’s session?



**Note:** Allow a moment for group members to respond.



■ **Say:**

I am looking forward to seeing you next week. The next session will be a review and graduation celebration.

- **Ask** group members if they want a potluck dinner at the final session. If so, ask for volunteers to bring heart healthy dishes. Do not forget nonfood items, such as paper plates, cups, and plastic forks and spoons.



**Note for Educator:** Think about today's session. What worked and what didn't work? Have you made any changes in your own life to quit smoking (if you smoke) and decrease exposure to secondhand smoke?

# A Smoke-Free Life Role Play

---

Mila and Helena are sitting on a bench as they take a break from window shopping. Before taking *merienda* (snack time), Mila says she needs a smoke.

**Helena:** When did you start smoking, Mila? I do not remember you ever smoking. You know that it is not good for your health! What would your mom say?

**Mila:** Oh, *Ate*,\* it is nothing big. Smoking is something I picked up since moving to the United States. You see women here smoking all the time on television and in the movies. Besides, smoking relaxes me. Life is not always easy here, and I feel a lot of stress.

**Helena:** What about your family? If you are smoking around your children and their friends, they will breathe in the same smoke. Secondhand smoke is dangerous, especially for children. Secondhand smoke can trigger an asthma attack.

**Mila:** Are you sure that is true, *Ate*? That worries me, because my daughter Marites has asthma.

**Helena:** My *tatay*† smoked his whole life. What a waste of his health and his money. Do you ever think about how much money you could save if you stopped buying cigarettes? Even more important, think about the health of your children and the people around you, Mila.

**Mila:** I have thought about quitting, but it seems hard. I smoke without even thinking about it.

**Helena:** Well, sometimes you need to sacrifice. Mama always says, “*Walang tagumpay, kung walang paghihirap.*” “There is no success if there is no sacrifice.” I will help you any way I can, and I am sure your family will support you in quitting.

**Mila:** Thank you for being a good friend, Helena. I will start trying to quit right now by putting out this cigarette.

\* *Ate* means “elder sister” in Tagalog.

† *Tatay* means “father” in Tagalog.

# Smoking Harms You

---

## Smoking can cause:

### ■ Heart attack and stroke

- Cigarette smokers are two to four times more likely to develop heart disease than nonsmokers.
- Smoking doubles your chances for having a stroke.
- One year after a person stops smoking, the risk of having a heart attack or stroke will drop by more than half.

### ■ Cancer

- Smoking increases your risk of developing cancers of the bladder, kidney, larynx (voice box), lung, pancreas, stomach, and uterus.
- Smoking causes about 80 to 90 percent of lung cancer.
- The cancer death rate for men who smoke cigarettes is more than double that of nonsmokers.
- Men who smoke are 22 times more likely to develop lung cancer than men who have never smoked.
- Women who smoke are 12 times more likely to develop lung cancer than women who have never smoked.

## Smoking and secondhand smoke can cause:

- Chronic obstructive pulmonary disease (COPD), which includes emphysema and chronic bronchitis
- More colds, sore throats, and respiratory infections
- Asthma attacks
- Increased risk to developing heart disease

## Unpleasant effects of smoking include:

- Yellow stains on teeth and fingers
- Bad breath
- Gum disease
- Early wrinkling of the skin
- Decreased sense of smell and taste



# Smoking Harms Infants and Children

---



Each time a pregnant woman smokes, her baby's heart rate increases.

---

When a pregnant woman smokes, her baby gets less oxygen.

---

The birth weight of babies born to smokers is lower than the birth weight of babies born to nonsmokers.

---

Smoking during pregnancy increases the chance of the baby being born dead.

---

Babies whose mothers smoke have a greater risk of dying from SIDS (sudden infant death syndrome).

---

Harmful chemicals from smoking pass through the placenta and directly into the baby's blood.

---

If the mother continues to smoke after the baby is born, the baby is more likely to get chest colds, ear infections, bronchitis, pneumonia, and asthma.

---

Babies exposed to secondhand smoke are more likely to cry, sneeze, and cough than babies who are not.







---

Children who grow up in a home with smokers are more likely to become smokers.

---

# Costs of Smoking

Smoking one \$5 pack of cigarettes a day for . . .

1 Week	=	\$35	=		Rice maker or movie tickets for the family
2 Months	=	\$300	=		Karaoke machine
6 Months	=	\$900	=		Week at the beach with family or money to send home to relatives
1 Year	=	\$1,825	=		Computer
2 Years	=	\$3,650	=		Semester of college tuition
3 Years	=	\$5,475	=		Car down payment
4 Years	=	\$7,300	=		House down payment

# Role Play: Someone Is Smoking. What Can You Do?

---

## Scene 1

Your brother-in-law's friend comes to your home for a dinner party. Most of the family and guests are in the living room talking. Your brother-in-law's friend comes to the kitchen to ask you for an ashtray, as he lights up his cigarette. You know smoking around the children is harmful. What can you do?

## Solutions:

---

---

---

---

---

---

---

---

# Role Play: Someone Is Smoking. What Can You Do? *(continued)*

---

## Scene 2

You go out to eat with a friend to celebrate a special occasion. You ask to sit in the nonsmoking section of the restaurant. The nonsmoking area is in a corner of the restaurant. There are no walls separating the smoking section from the nonsmoking section. As you order your meal, four people sit down about three tables away from you in the smoking section. They begin to smoke one cigarette after another. After a minute or two, you begin to smell their smoke at your table. You tell the waiter the smoke is bothering you. He says he cannot ask them to stop, because they are in the smoking section. What do you do?

## Solutions:

---

---

---

---

---

---

---

---

# Role Play: Someone Is Smoking. What Can You Do? *(continued)*

---

## Scene 3

Your teenager comes home after school, smelling like smoke. What do you do?

## Solutions:

---

---

---

---

---

---

---

---



# Smoke-Free Family Sign

Thank You for Not Smoking.  
Smoke-Free Family.

We Are a 

We Are a   
Smoke-Free Family.  
Thank You for Not Smoking.

# Simbolo ng Pamilya na Malaya sa Usok

Salamat sa iyo para  
sa Hindi Paninigarilyo.  
Kami ay isang  
Pamilyang Malaya  
sa Usok.

Kami ay isang  
Pamilyang Malaya  
sa Usok.  
Salamat sa iyo para  
sa Hindi Paninigarilyo.

# Tips To Quit Smoking

**Cigarette smoke contains more than 4,000 chemicals,  
and 200 of them are poisonous.**

## Get ready.

- Set a quit date. Pick a date within the next 2 weeks. Think about choosing a special day to you, such as your birthday or a holiday, if it's within 2 weeks.
- Throw away ALL cigarettes, lighters, matches, and ashtrays in your home, car, and place of work.
- Do not let people smoke in your home.
- Do not try to cut back on cigarettes by buying one at a time instead of buying the pack. This costs more money, and you can lose count and end up smoking more cigarettes.
- Review your past attempts to quit. Think about what worked and what didn't.
- Once you quit, don't smoke—NOT EVEN A PUFF! One cigarette can cause you to start smoking again.

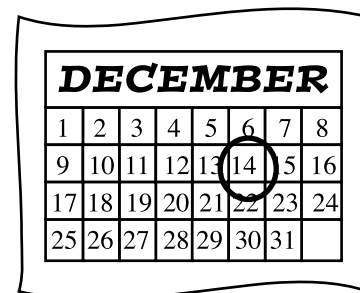

## Line up support.

- Tell your family, friends, and coworkers that you are going to quit smoking and want their help. Ask them not to smoke around you and not to offer you cigarettes.
- Get individual, group, or telephone counseling. The more counseling you have, the better your chances are of quitting.
- Meditate, chant, or think positively about quitting and breaking the smoking habit for good.
- Find out whether your church, faith community, or other community organization sponsors quit-smoking clinics or other activities that will support you in quitting smoking.

## Find ways to relax.

- Try to distract yourself from urges to smoke. Talk to someone, go for a walk, or get busy with a task.
- Change your routine. Use a different route to work. Drink tea instead of coffee.
- Do something to reduce your stress. Listen to music, talk to a friend, or walk around the neighborhood.
- Plan something enjoyable to do every day.
- Drink a lot of water when you feel the urge to smoke.

# Tips To Quit Smoking *(continued)*

---

## **Use other quitting aids.**

- Talk to your doctor or other health care provider. Consider using the nicotine patch, nicotine gum, nicotine nasal spray, or nicotine inhaler to help you stay off cigarettes.
- Check with your doctor about a medicine called bupropion SR. This medicine can help reduce your cravings for smoking.

## **Be prepared if you do not have immediate success.**

- Avoid drinking alcohol. Drinking alcohol lowers your chances of success.
- Spend more time with friends who do not smoke. Being around smoking can make you want to smoke.
- Many smokers will gain weight when they quit, usually fewer than 10 pounds. Eat healthy and stay active. Do not let weight gain distract you from your main goal—quitting smoking.
- If you are in a bad mood or feel depressed, try a new activity. Take a walk, talk to a friend, or meditate to improve your mood.
- Be kind to yourself. Remind yourself of the reasons you want to quit. If you slip, do not be discouraged. Try again!

# Mga Payo Upang Huminto Sa Paninigarilyo

Ang usok ng sigarilyo ay naglalaman nang higit sa 4,000 na mga kemikal, at 200 sa kanila ay nakakalason.

## ■ Maging handa.

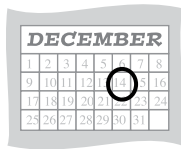
- Magtakda ng isang petsa ng pagtigil. Pumili ng isang petsa sa loob ng mga susunod na 2 linggo. Mag-isip tungkol sa pagpili ng isang espesyal na araw para sa iyo, tulad ng iyong kaarawan o isang piyesta opisyal, kung ito ay sa loob ng 2 linggo.
- 
- Itapon ang LAHAT ng mga sigarilyo, *lighter*, posporo, at *ashtray* sa iyong tahanan, kotse, at lugar ng pinagtrabahuan.
  - Huwag hayaan ang mga tao na manigarilyo sa iyong tahanan.
  - Huwag subukan ang pagtigil sa paninigarilyo sa pagbili ng paisa-isa sa halip ng pagbili ng pakete. Mas lalaki ang iyong gastos, at maaari mong makalimutan bigla at magtatapos sa paninigarilyo ng mas maraming mga sigarilyo.
  - Repasuhin ang iyong mga nakalipas na pagtatangka na pagtigil. Isipin ang tungkol kung ano ang gumana at ano ang hindi.
  - Kapag tumigil ka na, huwag ng maninigarilyo—KAHIT NA ISANG PAG-HITHIT! Isang sigarilyo ay maaaring mag-sanhi sa iyo na magsimula muling manigarilyo.

## ■ Suportang *line up*.

- Sabihin sa iyong pamilya, mga kaibigan, at kasama sa trabaho na ikaw ay titigil ng manigarilyo at nais ang kanilang tulong. Hilingin sa kanila na huwag manigarilyo palibot sa iyo at huwag mag-alok sa iyong ng mga sigarilyo.
- Kumuha ng indibidwal, pangkat, o pagpapayo sa telepono. Ang mas maraming pagpapayo na mayroon ka, ang mas mahusay na iyong mga pagkakataon sa pagtigil.
- Pagninilay, pagbulong, o positibong pag-iisip tungkol sa paghinto at tigilan na nang lubusan ang paninigarilyo.
- Tuklasin kung ang iyong simbahan, pamayanan sa pananampalataya, o iba pang mga samahan sa pamayanan na klinika na nag-*sponsor* sa pagtigil sa paninigarilyo o iba pang mga aktibidad na sumusuporta sa iyo sa pagtigil ng paninigarilyo.

# Mga Payo Upang Huminto Sa Paninigarilyo *(continued)*

---

## ■ Maghanap ng mga paraan upang ma-relax.

- Subukan na ibaling ang iyong sarili mula sa pagka-gusto upang manigarilyo. Makipag-usap, maglakad, o maging abala na may isang gawain.
- Baguhin ang iyong mga naka-gawian. Gamitin ang isang naiibang naka-gawian upang gumawa. Uminom ng *tea* sa halip na kape.
- Gumawa ng isang bagay upang mabawasan ang iyong stress. Sa makinig musika, makipag-usap sa isang kaibigan, o maglakad palibot sa kapitbahay.
- Mag-plano ng isang kasiya-siya upang magawa araw-araw.
- Uminom ng maraming tubig kapag nakakaramdam ka ng kagustuhang manigarilyo.

## ■ Gumamit ng iba pang mga pantulong sa pagtigil.

- Magkipag-usap sa iyong doktor o iba pang nagbibigay ng mga pangangalaga sa kalusugan. Isaalang-alang ang paggamit ng *nicotine patch*, *nicotine gum*, *nicotine nasal spray*, o *nicotine inhaler* upang makatulong na lumayo sa mga sigarilyo.
- Suriin sa iyong doktor ang tungkol sa isang medisina na tinatawag na bupropion SR. Ang medisinaang ito ay maaaring makatulong na makabawas ng iyong mga paghahanap para sa paninigarilyo.

## ■ Maging handa kung wala kang agarang tagumpay.

- Iwasan ang pag-inom ng alkohol. Ang pag-inom ng alkohol ay nagpapababa ng iyong mga pagkakataon ng tagumpay.
- Maglaan ng mas maraming oras sa mga kaibigan na hindi naninigarilyo. Kung nasa paligid ka ng mga naninigarilyo ay maaaring naisin mong manigarilyo.
- Maraming sa mga naninigarilyo ang tumataba kapag sila ay tumigil, karaniwan mas mababa kaysa sa 10 libra. Kumain ng wasto at manatiling aktibo. Huwag hayaan na makasira ang pagtaba mula sa iyong pangunahing layunin—pagtigil sa paninigarilyo.
- Kung wala ka sa tamang kalagayan o nakakaramdam ng pagkabalisa, subukan ang isang bagong aktibidad. Maglakad, makipag-usap sa isang kaibigan o magnilay upang mapabuti ang iyong kalagayan.
- Maging mabait sa iyong sarili. Paalalahanan ang iyong sarili ng mga kadahilanan kung bakit nais mong tumigil. Kung nabigo ka, huwag masiraan ng loob. Subukan muli!

# Help Your Heart—Don't Smoke

**Smoking cigarettes is harmful.** It becomes an addiction that can lead to serious health problems. Quitting smoking will lower your risk of heart attack, stroke, and chronic obstructive pulmonary disease (known as COPD or lung disease). It will help you breathe easier and have more energy. In addition, your clothes, hair, and breath will smell fresher, and you will save money by not buying cigarettes. Most important, when you quit smoking, your children will not be exposed to your secondhand smoke. They will have your good example to follow.



Even if you do not smoke, it is important that you learn about the best ways to quit. Help those around you, and keep your children smoke free.



**Quit smoking and add years to your life!**

Mila decided to quit smoking. She made a firm pledge one morning, threw away her cigarettes, and used her willpower to quit for good. Mila used the following three tips and quit.

**1.**

**Learn how to handle urges to smoke.**

“Every time I felt stressed, I wanted to smoke. Instead of smoking, I found something to do, talked to a friend, or walked around the neighborhood.”

**2.**

**Get support.**

“I also attended a quit-smoking program in the clinic every Thursday night, and I got a lot of help from my family and the support group. Even my children are encouraging me.”

**3.**

**Use the nicotine patch or gum.**

“The doctor at the clinic suggested that I use the patch. The patch helped me control the urge to smoke.”

# Break Free From the Smoking Habit

## Lola Idad's tips to make your home smoke free

### Protect your children!

Talk to your children about the harm that smoking will do to their health. Help them practice saying, "No, thanks. I don't smoke."

If your children already smoke, the way you react can make a difference. Tell your children that you really care about them and what happens to them. Listen to their thoughts and feelings. Give them facts that can help them choose good health over smoking.

Make your personal pledge to protect your family from cigarette smoke.

### Here are some examples:

- If you smoke—

I will set a quit date today. (The important thing is for you to pick the date—not your doctor, not your family, not your kids. It is **your** decision.)

**My quit date is** \_\_\_\_\_ **(date)**

- To help your children stay smoke free—

I will talk to my children about the harmful effects of smoking cigarettes and cigars. I will encourage them to create a sign that says, "We are proud to be smoke-free kids."

**I will do this on** \_\_\_\_\_ **(date)**

- To protect your family, friends, and others from smokers—

I will let my family, friends, and others know that I do mind if they smoke around me. I will put a "No Smoking" sticker or sign in my house and car.

**I will do this on** \_\_\_\_\_ **(date)**

- To help your community—

I will encourage my neighbors and local businesses, such as restaurants, to be smoke free. I will give them "Thank You for Not Smoking" cards.

**I will do this on** \_\_\_\_\_ **(date)**

When a friend comes to our house and lights up a cigarette, I say very politely, "I'm sorry, we have a smoke-free home. Please smoke outside." And I keep a sign in my home that says, "Thank You for Not Smoking."

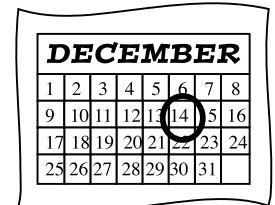

**The health of your family and yourself is priceless. Value it!**



# Lumaya Mula sa Kinagawiang Paninigarilyo

Mga Tip ni Lola Idad Upang Gawing Malaya sa Usok ang Iyong Tahanan

## Protektahan ang iyong mga anak!

Makipag-usap sa iyong mga anak tungkol sa masamang epekto ng paninigarilyo at ano ang magagawa nito sa kanilang kalusugan.

Tulungan silang sanayin sa pagsasabi ng, “Huwag, salamat. Hindi ako naninigarilyo.”

Pag may kaibigan na pumunta sa aming bahay at nagsindi ng cigarillo, magalang kong sinasabi, “Pasensiya ka na at walang naninigarilyo sa bahay na ito. Puedeng sa labas ka na manigarillo?” At laging may paskel sa aming bahay na, “Bawal and manigarillo sa bahay. Salamat sa inyong pagunawa.”



Kung ang inyong mga anak ay naninigarilyo na, ang paraan kung paano ka magbigay ng reaksiyon ay maaari makagawa ng isang pagbabago. Sabihin sa iyong mga anak na talagang nagmamalasakit ka sa kanila at kung ano ang mga mangyayai sa kanila. Makinig sa kanilang mga pananaw at nararamdaman. Bigyan sila ng mga katunayan na makakatulong sa kanila na pumili ng mabuting kalusugan laban sa paninigarilyo.

Gumawa ng iyong pampersonal na pangako upang protektahan ang iyong pamilya mula sa usok ng sigarilyo.

## Narito ang ilang mga halimbawa:

### ■ Kung naninigarilyo ka—

Magtatakda ako ngayon ng isang petsa ng paghinto. (Ang mahalagang bagay para sa iyo ay pumili ng petsa—hindi ang iyong duktor, hindi ang iyong pamilya, hindi ang iyong mga anak. Ito ay iyong sariling pagpapasya.)

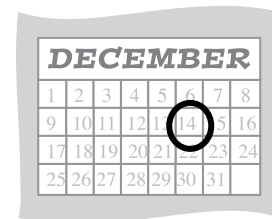

Ang petsa ng aking paghinto ay \_\_\_\_\_ (petsa).

# Lumaya Mula sa Kinagawiang Paninigarilyo *(continued)*

## Mga Tip ni Lola Idad Upang Gawing Malaya sa Usok ang Iyong Tahanan

---

### ■ Upang tulungan ang iyong mga anak na manatiling malaya sa usok—

Kakausapin ko ang aking mga anak tungkol sa mga nakasasamang epekto ng paninigarilyo at pananabako. Hihikayatin ko sila na lumikha ng isang simbolo na nagsasabing, “Ipinagmamalaki naming maging mga batang malaya sa usok.”

Gagawin ko ito sa \_\_\_\_\_ (petsa).

### ■ Upang protektahan ang iyong pamilya, mga kaibigan, at iba pa mula sa mga naninigarilyo—

■ Hahayaan kong malaman ng aking pamilya, mga kaibigan, at iba pa na gagawin ko kung naninigarilyo sila palibot sa akin. Maglalagay ako ng isang “Bawal Manigarilyo” na sticker o simbolo sa aking tahanan at kotse.



Gagawin ko ito sa \_\_\_\_\_ (petsa).

### ■ Upang makatulong sa iyong pamayanan—

■ Hihikayatin ko ang aking mga kapitbahay at lokal na negosyo, tulad ng mga restawrant, na maging malaya sa usok. Bibigyan ko sila ng “Salamat sa Iyong Hindi Paninigarilyo” na mga *card*.

Gagawin ko ito sa \_\_\_\_\_ (petsa).

**Ang kalusugan ng iyong pamilya at ng iyong sarili ay walang katumbas na halaga. Pahalagahan ito!**

# Lola's Life Lessons: Session 10

---

One of my favorite proverbs is:

*“Walang tagumpay, kung walang paghihirap.”*

Translation: “There is no success if there is no sacrifice.”

It was very difficult for your *Lolo*\* to quit smoking. Back home, all the men began smoking at an early age. Your Lolo told me he started smoking as a soldier during World War II. It became a habit that was hard for him to break. He said it helped him feel better when he was under a lot of stress. Until his last days, he was unable to quit. He knew it was not good for him.

I hated the smoke, especially because it made everything smell bad. The money he spent on cigarettes could have been used for so many other things. If only he had been willing to sacrifice, your Lolo may have been with us longer.

Do not give up hope! There are many sacrifices to make before you can see success. Take small steps to protect your heart. Be heart healthy, and make your life and your family's lives smoke free.

\* *Lolo* is Tagalog for grandfather. Not only the family, but the close network of community members also respectfully addresses him as Lolo.

## **A Time To Reflect...**

What things keep you from quitting smoking or eliminating secondhand smoking from your home?

(Use this space to write down your thoughts for this week's session.)

# Pledge for Life! Session 10

---

Take the pledge for life with Lola Idad's family. Try to do one or more of these activities by yourself or share with others.

- Know the dangers of smoking and secondhand smoke.
- If you smoke, set a quit date.
- Smoke half the usual daily number of cigarettes.
- Share the information about secondhand smoke with others.
- Encourage family and friends to smoke less often or quit.
- Encourage pregnant women not to smoke and not to inhale secondhand smoke.
- Talk to your children about the dangers of smoking.
- Display the smoke-free home sign.
- Ask your children to make a sign to let others know your home is smoke free.
- Begin saving the money spent on cigarettes for a special purchase, like a computer or a vacation.
- Other \_\_\_\_\_



# Review and Graduation

---

## Objectives

**This session is designed to:**

- Review information learned in Sessions 1 through 10 using games and activities.
- Recognize the group's efforts and accomplishments.

---

## Materials and Supplies

**To conduct this session, you will need:**

- “Healthy Heart, Healthy Family” manual and picture cards
- Heart Health Bingo Facts (pages 413–414)
- Heart Health Bingo Cards (pages 415–429)
- Bingo card markers (pennies, dry beans, or other items)
- Pens
- Stamped envelopes
- *(Optional)* Food (if having a potluck)
- *(Optional)* Small gift or certificate for each group member (pages 432–433)

---

## Handouts

### Give group members these handouts during this session:

- “Heart Disease Risk Factors You Can Do Something About” (pages 410–412)
- “Heart Health Bingo Facts” (pages 413–414)\*
- “Heart Health Bingo Cards” (pages 415–429)\*
- *(Optional)* “Letter to Myself Sample” (page 430)
- “Letter to Myself” (page 431)
- “Certificate of Achievement” (page 432–433)<sup>†</sup>
- “Lola’s Favorite Proverbs” (page 434)

---

## Session Outline

### Introducing the Session

1. Welcome
2. Review of Last Week’s Session
3. About This Session

### Conducting the Session

1. Heart Health Bingo<sup>†</sup>
2. Letter to Myself Activity

---

\*Prepare the bingo cards and facts before the session.

<sup>†</sup> Prepare the certificates before the session. You can photocopy the “Certificate of Achievement” handout and write in the name of each participant, or you can find certificates in a business supply store.

# Recognition for Completing the Healthy Heart, Healthy Family Project

## *(Optional)* Potluck Meal

### Lola's Life Lessons: A Time To Reflect

## Closing

# Introducing the Session

---

## 1. Welcome

- Welcome group members to the session.

## 2. Review of Last Week's Session

- Say:

During Session 10, we talked about how cigarette smoking can harm you. Who can name some of the harmful effects of smoking?



**Note:** Allow 3 to 5 minutes for group members to answer. **Write** their answers on the blackboard or on a large piece of paper taped to the wall.

- Add these reasons if they are not mentioned.

- Cigarette smoking can cause health problems, such as:
  - Heart disease      — Stroke      — Asthma
  - Cancer      — Emphysema
- Cigarette smoking irritates the eyes and can trigger asthma attacks.
- Less serious, but very unpleasant, effects of smoking include:



- Yellow stains on teeth and fingers
- Bad breath
- Poorer sense of smell and taste
- Early wrinkling of the face
- Many colds and sore throats

■ **Ask:**

How did you do with your pledge to do one thing to quit smoking or to protect your family from secondhand smoke? Did anything work very well? Did anything cause a problem?

**Note:** Allow 5 to 8 minutes for group members to comment.

### 3. About This Session



■ **Say:**

Give group members the “Heart Disease Risk Factors You Can Do Something About” handout (pages 410–412).

■ **Say:**

During this session, we will go over information we learned in Sessions

1 through 10. Thank you all for taking part in the sessions, and congratulations on making the effort to learn how to lower the risk of heart disease, stroke, and diabetes for yourselves and your families.



■ **Say:**

The “Heart Disease Risk Factors You Can Do Something About” handout has a table of the risk factors for heart disease and the steps you can take to reduce the risk factors. This is a helpful guide that you can share with your families and friends. You can also share it with your health care provider at your next appointment to discuss whether you have any risk factors.

■ *(Optional)* **Ask:**

Would any of you like to share the steps you have taken or plan to take to reduce these risk factors?

■ **Say:**

As the members of the de la Cruz family have taken us through their personal journeys to heart health, Lola Idad has shared many life lessons with us. She reminds us to remember our paths to success as we complete this project.

■ **Say:**

*“Ang hindi marunong tumingin sa pinamggalingon, ay hindi makararating sa patuntunguhan.”* “Those who do know how to look back at where they came from will never get to their destinations.”

## Conducting the Session

---

### 1. Heart Health Bingo

**Note:** **Make** one copy of the “Heart Health Bingo Facts” handout (pages 413–414) on stiff paper, and **cut** the paper on the dotted lines. **Mix** the pieces, and **place** them in a box. Also, **make** one copy of each of the Heart Health Bingo Cards (pages 415–429) on stiff paper, and **cut** them out.



— **Give** one card to each person. **Give** each group member nine pennies, dry beans, or other items that can be used to mark the cards.

■ **Say:**

We are going to play a bingo game to review the facts about preventing heart disease, stroke, and diabetes. Here’s how to play:

1. To start, place a marker on the free space in the center of the card.
2. Listen as the bingo caller reads facts about heart health. These facts will be drawn from a box.
3. If the fact that is read matches a fact on your card, place a marker on it.

4. If you get three markers in a row, call out “Bingo!” The row can be up and down, across, or diagonal.

- **Hold** up a card to show the group how the rows can look.

**Note:** Play two or three games as time permits. At the end of each game, have the group members **turn in** their cards for new ones. If possible, you may want to **award** small prizes to the winners.



## 2. Letter to Myself Activity

**Note:** Bring a stamped envelope and pen for each group member. If you have group members who do not write well, let them tell you the information and you can write it down for them.



- **Give** each group member a pen, the “Letter to Myself” handout (page 431), and a stamped envelope. You may want to show or read aloud the “Letter to Myself Sample” handout (page 430) to give group members ideas.



- **Ask** the group members to use the handout to list healthy changes they will continue to work on until they become habits.
- **Tell** them to address the envelope to themselves and place the letter inside.
- **Say:**

I will mail your letter to you in about 3 months. Getting this letter will remind you to keep using what you’ve learned in these sessions to care for your heart.

## Recognition for Completing the Healthy

# Heart Healthy Family Training

---

- **Show picture card 11.1.**

- **Say:**

Everyone gave time and effort to attend the sessions. I hope you will use the information to help improve your heart health and that of your families.

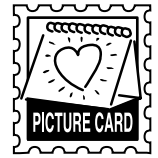

- *(Optional)* If you choose, **give** small gifts to group members.

- **Say:**

Now, I would like to give each of you a certificate to honor your efforts and your achievements.

- **Call** each group member's name, and **give** each person the "Certificate of Achievement" handout (pages 432–433) (and the small gift of recognition, if you have chosen to include that).



- **Say:**

Also, I have a list of Lola's favorite proverbs for you (page 434).

- **Say:**

Now you have a chance to talk about what you have found helpful. Would any of you like to share your families' reactions to your pledged activities?



**Note:** Allow a moment for group members to respond.

## *(Optional)* Potluck Meal

### ■ Say:

Now is the time for the potluck meal. Place the dishes you brought on the table. We will begin the celebration.

## Lola's Life Lessons: A Time To Reflect

### ■ Say:

In each session, Lola Idad and her family have encouraged us to achieve positive lifestyle changes. Lola shared her wisdom through Filipino proverbs, which help us to stay focused and provide us with support on the journey to better health.

### ■ Ask:

Are you ready to continue practicing the skills you have learned in this course and to share the benefits of a healthy lifestyle with your family?

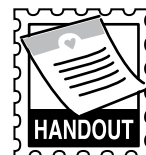

- *(Optional)* Ask two or three volunteers to share their experiences with the entire group.

**Note:** Allow about 5 to 10 minutes for discussion.

- Give group members the “Lola’s Favorite Proverbs” handout (page 434).

### ■ Say:

Here is a list of Lola Idad’s favorite proverbs, which have kept her motivated on her journey to heart health. Use these proverbs for inspiration on your own heart health journeys.

### ■ Say:

As we move forward with new knowledge, Lola reminds us again of Joe Rizal’s

famous quote, “*Ang hindi marunong tumingin sa pinamgalingon, ay hindi makararating sa patuntunguhan.*” This quote says, “Those who do not know how to look back at where they came from will never get to their destinations.” Remember and cherish how far you have come on this journey to heart health.

■ **Say:**

Lola Idad and her family congratulate you on all of the hard work you have done. Good luck and good heart health to you, your families, and friends!

## Closing

---



■ **Say:**

Thank you for coming and for completing the course. I wish everyone well, and I hope you continue your journeys toward good health and healthy hearts.

**Note for Educator:** Think about today’s session and about all of the training that you have done during the last few months. What do you think worked and what didn’t work? What changed in your own life as a result of what you learned during these sessions?

# Heart Disease Risk Factors You Can Do Something About

RISK FACTORS	FACTS YOU NEED TO KNOW	TAKE THESE STEPS TO PREVENT HEART DISEASE														
<p><b>High blood pressure</b></p> <p>High blood pressure (or hypertension) is called the “silent killer” because it often has no symptoms, yet it can cause very serious illness.</p> <p><b>Prehypertension</b></p> <p>You do not have high blood pressure yet, but are likely to develop it in the future unless you adopt healthy lifestyle changes.</p>	<p>When your blood pressure is high, your heart works harder than it should to move blood to all parts of the body. If not treated, high blood pressure can lead to stroke (brain attack), heart attack, eye and kidney problems, and death.</p> <p><b>Check your blood pressure numbers (mmHg*):</b></p> <table border="1" data-bbox="365 636 1019 835"> <thead> <tr> <th>Level</th> <th>Systolic</th> <th>Diastolic</th> </tr> </thead> <tbody> <tr> <td>Normal</td> <td>Less than 120</td> <td>Less than 80</td> </tr> <tr> <td>Prehypertension</td> <td>120–139</td> <td>80–89</td> </tr> <tr> <td>High Blood Pressure</td> <td>140 or higher</td> <td>90 or higher</td> </tr> </tbody> </table> <p>* Millimeters of mercury</p>	Level	Systolic	Diastolic	Normal	Less than 120	Less than 80	Prehypertension	120–139	80–89	High Blood Pressure	140 or higher	90 or higher	<ul style="list-style-type: none"> <li>• Check your blood pressure once a year. Check it more often if you have high blood pressure.</li> <li>• Aim for a healthy weight.</li> <li>• Be physically active on most days.</li> <li>• Choose and prepare foods with less salt and sodium.</li> <li>• Eat more fruits, vegetables, and low-fat dairy products.</li> <li>• If you drink alcohol, do so in moderation.</li> <li>• If your doctor gives you blood pressure medicine, take it the way the doctor tells you.</li> </ul>		
Level	Systolic	Diastolic														
Normal	Less than 120	Less than 80														
Prehypertension	120–139	80–89														
High Blood Pressure	140 or higher	90 or higher														
<p><b>High blood cholesterol</b></p> <p>Cholesterol in your arteries is like rust in a pipe. Low-density lipoprotein (LDL) is known as the “bad” cholesterol. Too much LDL cholesterol can clog your arteries, which increases the risk of heart disease and stroke. High-density lipoprotein (HDL) is known as the “good” cholesterol. HDL carries cholesterol away from your arteries.</p>	<p><b>Check your total cholesterol number (mg/dL*):</b></p> <table border="1" data-bbox="365 1102 1019 1255"> <tbody> <tr> <td>Desirable</td> <td>Less than 200</td> </tr> <tr> <td>Borderline High</td> <td>200–239</td> </tr> <tr> <td>High</td> <td>240 or higher</td> </tr> </tbody> </table> <p><b>Check your LDL cholesterol number<sup>†</sup> (mg/dL*):</b></p> <table border="1" data-bbox="365 1354 1019 1585"> <tbody> <tr> <td>Desirable</td> <td>Less than 100</td> </tr> <tr> <td>Near Desirable/ Above Desirable</td> <td>100–129</td> </tr> <tr> <td>Borderline High</td> <td>130–159</td> </tr> <tr> <td>High</td> <td>160 or higher</td> </tr> </tbody> </table> <p>* Milligrams per deciliter</p> <p><sup>†</sup> The goal for LDL cholesterol is different for everyone. Your doctor can help you set your LDL goal.</p> <p>Check your HDL cholesterol number (mg/dL): HDL levels of 60 mg/dL or higher help lower your risk of heart disease. HDL levels below 40 mg/dL are a major risk factor for heart disease.</p> <p><b>Check your triglyceride level (mg/dL):</b> A normal triglyceride level is below 150 mg/dL.</p>	Desirable	Less than 200	Borderline High	200–239	High	240 or higher	Desirable	Less than 100	Near Desirable/ Above Desirable	100–129	Borderline High	130–159	High	160 or higher	<ul style="list-style-type: none"> <li>• Get a blood test called a lipid profile at your doctor’s office. This test measures all your cholesterol levels (total, LDL, and HDL) and triglycerides.</li> <li>• Get your blood cholesterol levels checked every 5 years if you are age 20 or older.</li> <li>• Learn what your cholesterol numbers mean. If they are high, ask your doctor how you can lower them.</li> <li>• Choose foods that are lower in saturated fat, <i>trans</i> fat, and cholesterol.</li> <li>• Aim for a healthy weight.</li> <li>• Be physically active.</li> </ul> <p>Take these other steps to control triglycerides:</p> <ul style="list-style-type: none"> <li>• Limit candy, sweets, regular soda, juice, and other beverages high in sugar.</li> <li>• Avoid smoking and alcohol. Smoking raises triglycerides and lowers HDL cholesterol. Excess alcohol also raises triglycerides.</li> </ul>
Desirable	Less than 200															
Borderline High	200–239															
High	240 or higher															
Desirable	Less than 100															
Near Desirable/ Above Desirable	100–129															
Borderline High	130–159															
High	160 or higher															

# Heart Disease Risk Factors You Can Do Something About *(continued)*

RISK FACTORS	FACTS YOU NEED TO KNOW	TAKE THESE STEPS TO PREVENT HEART DISEASE										
<p><b>Overweight/Obesity</b></p> <p>Overweight/obesity occurs when extra fat is stored in your body. It increases your risk of developing high blood pressure, high blood cholesterol, heart disease, stroke, and diabetes.</p>	<p><b>Check your body mass index (BMI) and waist measure:</b></p> <table border="1" data-bbox="565 464 1073 705"> <thead> <tr> <th>Category</th> <th>BMI</th> </tr> </thead> <tbody> <tr> <td>Underweight</td> <td>&lt;18.5</td> </tr> <tr> <td>Normal*</td> <td>18.5–24.9</td> </tr> <tr> <td>Overweight*</td> <td>18.5–24.9</td> </tr> <tr> <td>Obese*</td> <td>30 or greater</td> </tr> </tbody> </table> <ul style="list-style-type: none"> <li>A waist measurement greater than 35 inches (88 cm) for a woman and greater than 40 inches (102 cm) for a man increases the risk of heart disease.</li> </ul> <p>*Other reports indicate that the BMI cutoffs for overweight (&gt;23.0 kg/m<sup>2</sup>) and obesity (&gt;25.0 kg/m<sup>2</sup>) in the Asian-Pacific region are lower than the current standards (<i>Clinical Guidelines on the Identification, Evaluation, and Treatment of Overweight and Obesity in Adults</i>).</p>	Category	BMI	Underweight	<18.5	Normal*	18.5–24.9	Overweight*	18.5–24.9	Obese*	30 or greater	<ul style="list-style-type: none"> <li>Get your BMI and waist measured every 2 years, or more often if your doctor recommends it.</li> <li>Aim for a healthy weight. Try not to gain extra weight.</li> <li>If you are overweight, try to lose weight slowly. Lose 1 to 2 pounds (0.45 kg to 0.91 kg) a week.</li> <li>Eat smaller portions, and be physically active for at least 60 minutes daily.</li> </ul>
Category	BMI											
Underweight	<18.5											
Normal*	18.5–24.9											
Overweight*	18.5–24.9											
Obese*	30 or greater											
<p><b>Diabetes</b></p> <p>When the sugar in the blood is high, your body cannot use the food you eat for energy.</p> <p><b>Prediabetes</b></p> <p>Prediabetes is when blood glucose levels are higher than normal, but not yet high enough to be diagnosed as diabetes. People with prediabetes are at higher risk for cardiovascular disease.</p>	<ul style="list-style-type: none"> <li>Diabetes is serious. You may not know you have it. It can lead to heart attacks, blindness, amputations, and kidney disease.</li> <li>Being overweight is a major risk factor for type 2 diabetes.</li> <li>Filipino Americans are at higher risk for type 2 diabetes than the non-Hispanic Caucasian population.</li> </ul>	<ul style="list-style-type: none"> <li>Find out if you have diabetes.</li> <li>Get your blood glucose (blood sugar) level checked at least every 3 years, beginning at the age of 45. You should be tested at a younger age and more often if you are at risk for diabetes.</li> </ul>										



# Heart Disease Risk Factors You Can Do Something About *(continued)*

RISK FACTORS	FACTS YOU NEED TO KNOW	TAKE THESE STEPS TO PREVENT HEART DISEASE
<p><b>Not being physically active</b></p> <p>Being inactive can double your chances of heart disease and take away years from your life.</p>	<ul style="list-style-type: none"> <li>• Adults should do at least 30 minutes of moderate physical activity on most days, preferably every day of the week.</li> <li>• Many adults need 60 minutes of moderate (medium-level) to vigorous (high-level) activity on most days, preferably every day of the week, to prevent unhealthy weight gain.</li> <li>• Adults who used to be overweight need 60 to 90 minutes of moderate physical activity every day to avoid regaining weight.</li> <li>• Children and adolescents need at least 60 minutes of moderate to vigorous physical activity on most days and, preferably, every day of the week.</li> </ul>	<ul style="list-style-type: none"> <li>• Stay active. You can build up to 60 minutes of exercise each day by being active for 20 minutes three times a day.</li> <li>• Try walking, dancing, or playing basketball.</li> </ul>
<p><b>Smoking</b></p> <p>You put your health and your family's health at risk when you smoke.</p>	<ul style="list-style-type: none"> <li>• Cigarette smoking is addictive. It harms your heart and lungs. It can raise your blood pressure and blood cholesterol and those of others around you.</li> </ul>	<ul style="list-style-type: none"> <li>• Stop smoking now, or cut back gradually.</li> <li>• If you cannot quit the first time, keep trying.</li> <li>• If you do not smoke, do not start.</li> </ul>

# Heart Health Bingo Facts

*(Photocopy and cut on the dotted lines.)*

Protect your heart. When the heart stops, life stops.	✂ If your waist measurement is high, you are at risk for heart disease.
Physical activity makes your heart and lungs stronger.	Each day, do at least 30 to 60 minutes of physical activity, and encourage your children to be active for 60 minutes.
Warning signs of a stroke are numbness of the face, arm, or leg; confusion; trouble seeing; trouble walking; dizziness; and severe headache.	It is best to have a blood pressure reading below 120/80 millimeters of mercury (mmHg).
A blood pressure reading of 140/90 millimeters of mercury (mmHg) or greater is high blood pressure.	Eat less salt and sodium to help prevent high blood pressure.
Hypertension is another term for high blood pressure.	Heart attack warning signs are pain in the chest, arms, back, neck, or jaw; difficulty breathing; light-headedness; cold sweat; and feeling sick to your stomach.
Use herbs and spices instead of salt.	If you are prescribed blood pressure or cholesterol medication, take it as the doctor tells you.
Being overweight increases your risk of heart disease and diabetes.	Being overweight increases your risk of high blood pressure, high blood cholesterol, and diabetes.
People with diabetes are at risk for heart disease or stroke.	If someone is having a heart attack or stroke, call 9-1-1 right away.
To maintain or lose weight, cut down on portion size and be more active.	The Nutrition Facts label gives the serving size and the number of calories in a serving.
A body mass index (BMI) tells you if you are overweight. A BMI under 25 is a healthy weight.	Eat more fruit each day. Have a banana with your cereal for breakfast.

# Heart Health Bingo Facts *(continued)*

*(Photocopy and cut on the dotted lines.)*

<p>Eat more vegetables each day.</p>	<p style="text-align: center;">✂</p> <p>When eating out or at home, have baked, steamed, broiled, or grilled foods to cut down on fat and calories.</p>
<p>To save food dollars, plan weekly menus. Shop with a list!</p>	<p>Cook with vegetable oil instead of lard or coconut oil.</p>
<p>Smoking causes serious health problems such as heart disease and lung cancer.</p>	<p>Pregnant women should not smoke.</p>
<p>Nonsmokers exposed to secondhand smoke increase their risk of developing heart disease by 25 percent to 30 percent.</p>	<p>A desirable LDL (“bad”) blood cholesterol level is below 100 milligrams per deciliter (mg/dL).</p>
<p>Prediabetes means that you are at risk for developing type 2 diabetes. Act now—lose weight if overweight, and become active.</p>	<p>Cholesterol can clog your arteries and cause a heart attack or stroke.</p>
<p>The signs of diabetes are increased thirst, hunger, and urination; fatigue; weight loss; blurred vision; and sores that don’t heal.</p>	<p>Trim visible fat from meat before cooking.</p>
<p>Use the Nutrition Facts label to choose foods lower in saturated fat, <i>trans</i> fat, and cholesterol.</p>	<p>Saturated fat is found in high-fat meat, cheese, milk, and butter.</p>
<p>High blood pressure makes your heart work harder.</p>	<p>Cook more food than you need, and freeze part to use when you don’t have a lot of time to cook.</p>
<p>Steamed rice, fruits, fish and seafood, and other favorite Filipino foods are naturally low in fat.</p>	<p>Drain meat after it is cooked to get rid of some of the fat.</p>
<p>A healthy triglyceride level is less than 150 milligrams per deciliter (mg/dL).</p>	<p>To reduce the risk of heart disease and diabetes, keep your weight healthy and be physically active.</p>

# Heart Health Bingo Card 1

## Heart Health Bingo



Warning signs of a stroke are numbness of the face, arm, or leg; confusion; trouble seeing; trouble walking; dizziness; and severe headache.

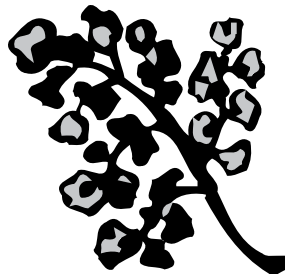

Use herbs and spices instead of salt.



Nonsmokers exposed to secondhand smoke increase their risk of developing heart disease by 25 percent to 30 percent.



Trim visible fat from meat before cooking.

♥  
**FREE  
SPACE**



The signs of diabetes are increased thirst, hunger, and urination; fatigue; weight loss; blurred vision; and sores that don't heal.

Nutrition Facts	
Serving Size 1 oz	
Servings Per Container 7	
Amount Per Serving	
Calories 120	Calories from Fat 90
% Daily Value*	
Total Fat 10g	15%
Saturated Fat 7g	35%
Trans Fat 0g	
Cholesterol 30mg	10%
Sodium 180mg	8%
Total Carbohydrate 1g	0%
Dietary Fiber 0g	0%
Sugars 0g	
Protein 6g	
Vitamin A 6%	Vitamin C 0%
Calcium 20%	Iron 0%

Use the Nutrition Facts label to choose foods lower in saturated fat, *trans* fat, and cholesterol.



It is best to have a blood pressure reading below 120/80 millimeters of mercury (mmHg).

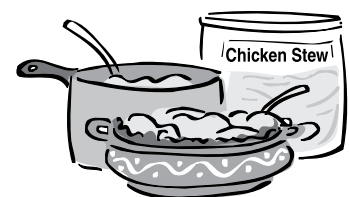

Cook more food than you need, and freeze part to use when you don't have a lot of time to cook.

# Heart Health Bingo Card 2

## Heart Health Bingo



High blood pressure makes your heart work harder.



Steamed rice, fruits, fish and seafood, and other favorite Filipino foods are naturally low in fat.

Nutrition Facts	
Serving Size 1 oz	
Servings Per Container 7	
Amount Per Serving	
Calories 120	Calories from Fat 90
% Daily Value*	
<b>Total Fat</b> 10g	15%
<b>Saturated Fat</b> 7g	35%
<b>Trans Fat</b> 0g	
<b>Cholesterol</b> 30mg	10%
<b>Sodium</b> 180mg	8%
<b>Total Carbohydrate</b> 1g	0%
Dietary Fiber 0g	0%
Sugars 0g	
<b>Protein</b> 6g	
Vitamin A 6%	Vitamin C 0%
Calcium 20%	Iron 0%

Use the Nutrition Facts label to choose foods lower in saturated fat, *trans* fat, and cholesterol.



If someone is having a heart attack or stroke, call 9-1-1 right away.



**FREE  
SPACE**

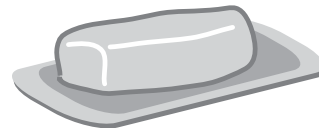

Saturated fat is found in high-fat meat, cheese, milk, and butter.



A blood pressure reading of 140/90 millimeters of mercury (mmHg) or greater is high blood pressure.



If your waist measurement is high, you are at risk for heart disease.



Pregnant women should not smoke.

# Heart Health Bingo Card 3

## Heart Health Bingo



Nonsmokers exposed to secondhand smoke increase their risk of developing heart disease by 25 percent to 30 percent.

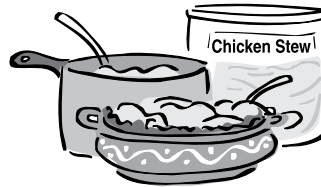

Cook more food than you need, and freeze part to use when you don't have a lot of time to cook.



To reduce the risk of heart disease and diabetes, keep your weight healthy and be physically active.



Protect your heart. When the heart stops, life stops.

♥  
**FREE  
SPACE**



Eat less salt and sodium to help prevent high blood pressure.



To maintain or lose weight, cut down on portion size, and be more active.



Eat more vegetables each day. Have a salad for lunch.



Prediabetes means that you are at risk for developing type 2 diabetes. Act now—lose weight if overweight, and become active.

# Heart Health Bingo Card 4

## Heart Health Bingo



Cholesterol can clog your arteries and cause a heart attack or stroke.



Eat more fruit each day. Have a banana with your cereal for breakfast.



Hypertension is another term for high blood pressure.



Smoking causes serious health problems, such as heart disease and lung cancer.

♥  
**FREE  
SPACE**

Nutrition Facts	
Serving Size 1 oz	
Servings Per Container 7	
Amount Per Serving	
Calories 120	Calories from Fat 90
% Daily Value*	
<b>Total Fat</b> 10g	15%
<b>Saturated Fat</b> 7g	35%
<b>Trans Fat</b> 0g	
<b>Cholesterol</b> 30mg	10%
<b>Sodium</b> 180mg	8%
<b>Total Carbohydrate</b> 1g	0%
Dietary Fiber 0g	0%
Sugars 0g	
<b>Protein</b> 6g	
Vitamin A 6%	Vitamin C 0%
Calcium 20%	Iron 0%

The Nutrition Facts label gives the serving size and the number of calories in a serving.



Heart attack warning signs are pain in the chest, arms, back, neck, or jaw; difficulty breathing; light-headedness; cold sweat; and feeling sick to your stomach.



A desirable LDL (“bad”) blood cholesterol level is below 100 milligrams per deciliter (mg/dL).

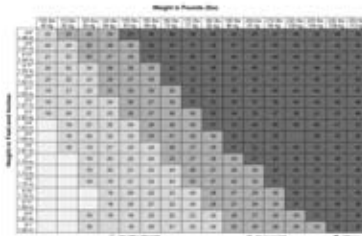

A BMI (body mass index) tells you if you are overweight. A BMI under 25 is a healthy weight.

# Heart Health Bingo Card 5

## Heart Health Bingo



Each day, do at least 30 to 60 minutes of physical activity, and encourage your children to be active for 60 minutes.

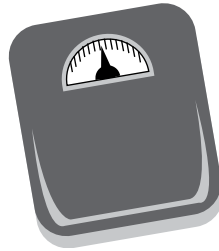

Being overweight increases your risk of heart disease and diabetes.



Cook with vegetable oil instead of lard or coconut oil.



When eating out or at home, have baked, steamed, broiled, or grilled foods to cut down on fat and calories.

♥  
**FREE  
SPACE**



A healthy triglyceride level is below 150 milligrams per deciliter (mg/dL).

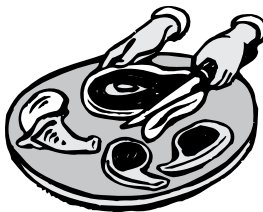

Trim visible fat from meat before cooking.



If you are prescribed blood pressure or cholesterol medication, take it as the doctor tells you.



To save food dollars, plan weekly menus. Shop with a list!



# Heart Health Bingo Card 6

## Heart Health Bingo

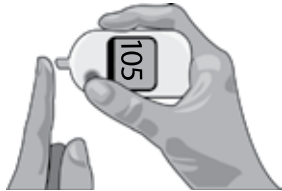

The signs of diabetes are increased thirst, hunger, and urination; fatigue; weight loss; blurred vision; and sores that don't heal.



Drain meat after it is cooked to get rid of some of the fat.



It is best to have a blood pressure reading below 120/80 millimeters of mercury (mmHg).



People with diabetes are at risk for heart disease or stroke.

♥  
**FREE  
SPACE**

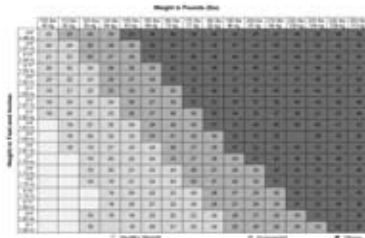

A BMI (body mass index) tells you if you are overweight. A BMI under 25 is a healthy weight.



Warning signs of a stroke are numbness of the face, arm, or leg; confusion; trouble seeing; trouble walking; dizziness; and severe headache.



If your waist measurement is high, you are at risk for heart disease.



Hypertension is another term for high blood pressure.

# Heart Health Bingo Card 7

## Heart Health Bingo



A desirable LDL (“bad”) blood cholesterol level is below 100 milligrams per deciliter (mg/dL).



Physical activity makes your heart and lungs stronger.



Hypertension is another term for high blood pressure.



Eat more vegetables each day. Have a salad for lunch.



**FREE  
SPACE**



A healthy triglyceride level is below 150 milligrams per deciliter (mg/dL).



Pregnant women should not smoke.

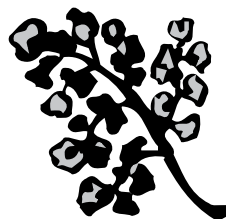

Use herbs and spices instead of salt.



A blood pressure reading of 140/90 millimeters of mercury (mmHg) or greater is high blood pressure.

# Heart Health Bingo Card 8

## Heart Health Bingo



Steamed rice, fruits, fish and seafood, and other favorite Filipino foods are naturally low in fat.

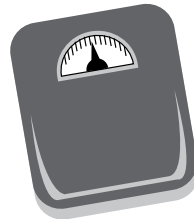

Being overweight increases your risk of high blood pressure, high blood cholesterol, and diabetes.



Physical activity makes your heart and lungs stronger.



Smoking causes serious health problems, such as heart disease and lung cancer.



**FREE  
SPACE**



Cook with vegetable oil instead of lard or coconut oil.



A blood pressure reading of 140/90 millimeters of mercury (mmHg) or greater is high blood pressure.



To save food dollars, plan weekly menus. Shop with a list!

Nutrition Facts	
Serving Size 1 oz	
Servings Per Container 7	
Amount Per Serving	
Calories 120	Calories from Fat 90
% Daily Value*	
<b>Total Fat</b> 10g	15%
<b>Saturated Fat</b> 7g	35%
<b>Trans Fat</b> 0g	
<b>Cholesterol</b> 30mg	10%
<b>Sodium</b> 180mg	8%
<b>Total Carbohydrate</b> 1g	0%
Dietary Fiber 0g	0%
Sugars 0g	
<b>Protein</b> 6g	
Vitamin A 6%	Vitamin C 0%
Calcium 20%	Iron 0%

The Nutrition Facts label gives the serving size and the number of calories in a serving.

# Heart Health Bingo Card 9

## Heart Health Bingo



Each day, do at least 30 to 60 minutes of physical activity, and encourage your children to be active for 60 minutes.



Eat more vegetables each day. Have a salad for lunch.



Drain meat after it is cooked to get rid of some of the fat.



People with diabetes are at risk for heart disease or stroke.

♥  
**FREE  
SPACE**



To reduce the risk of heart disease and diabetes, keep your weight healthy and be physically active.



Cholesterol can clog your arteries and cause a heart attack or stroke.



When eating out or at home, have baked, steamed, broiled, or grilled foods to cut down on fat and calories.



Protect your heart. When the heart stops, life stops.

# Heart Health Bingo Card 10

## Heart Health Bingo



Prediabetes means that you are at risk for developing type 2 diabetes. Act now—lose weight if overweight, and become active.

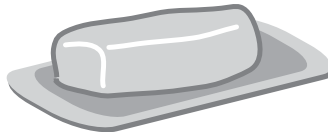

Saturated fat is found in high-fat meat, cheese, milk, and butter.



Eat less salt and sodium to help prevent high blood pressure.

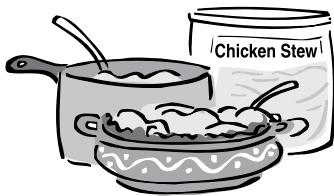

Cook more food than you need, and freeze part to use when you don't have a lot of time to cook.



**FREE  
SPACE**



Heart attack warning signs are pain in the chest, arms, back, neck, or jaw; difficulty breathing; light-headedness; cold sweat; and feeling sick to your stomach.

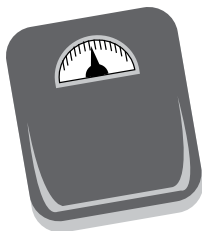

Being overweight increases your risk of heart disease and diabetes.



Nonsmokers exposed to secondhand smoke increase their risk of developing heart disease by 25 percent to 30 percent.



If someone is having a heart attack or stroke, call 9-1-1 right away.

# Heart Health Bingo Card 11

## Heart Health Bingo

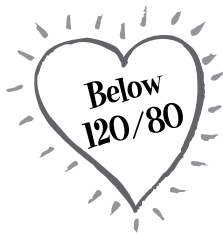

It is best to have a blood pressure reading below 120/80 millimeters of mercury (mmHg).

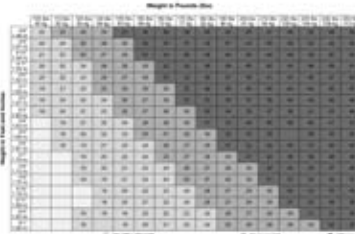

A BMI (body mass index) tells you if you are overweight. A BMI under 25 is a healthy weight.



Smoking causes serious health problems, such as heart disease and lung cancer.



To save food dollars, plan weekly menus. Shop with a list!

♥  
**FREE  
SPACE**



Eat more fruit each day. Have a banana with your cereal for breakfast.



To reduce the risk of heart disease and diabetes, keep your weight healthy and be physically active.



If your waist measurement is high, you are at risk for heart disease.



To maintain or lose weight, cut down on portion size, and be more active.

# Heart Health Bingo Card 12

## Heart Health Bingo

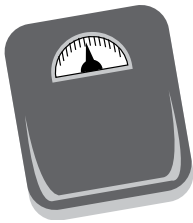

Being overweight increases your risk for heart disease, high blood cholesterol, and diabetes.



Each day, do at least 30 to 60 minutes of physical activity, and encourage your children to be active for 60 minutes.



Physical activity makes your heart and lungs stronger.



Cholesterol can clog your arteries and cause a heart attack or stroke.



**FREE  
SPACE**



To maintain or lose weight, cut down on portion size, and be more active.



Hypertension is another term for high blood pressure.

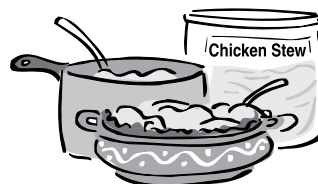

Cook more food than you need, and freeze part to use when you don't have a lot of time to cook.



Heart attack warning signs are pain in the chest, arms, back, neck, or jaw; difficulty breathing; light-headedness; cold sweat; and feeling sick to your stomach.



# Heart Health Bingo Card 13

## Heart Health Bingo



High blood pressure makes your heart work harder.



Steamed rice, fruits, fish and seafood, and other favorite Filipino foods are naturally low in fat.

Nutrition Facts	
Serving Size 1 oz	
Servings Per Container 7	
Amount Per Serving	
Calories 120	Calories from Fat 90
% Daily Value*	
<b>Total Fat</b> 10g	<b>15%</b>
<b>Saturated Fat</b> 7g	<b>35%</b>
<b>Trans Fat</b> 0g	
<b>Cholesterol</b> 30mg	<b>10%</b>
<b>Sodium</b> 180mg	<b>8%</b>
<b>Total Carbohydrate</b> 1g	<b>0%</b>
Dietary Fiber 0g	0%
Sugars 0g	
<b>Protein</b> 6g	
Vitamin A 6%	Vitamin C 0%
Calcium 20%	Iron 0%

Use the Nutrition Facts label to choose foods lower in saturated fat, *trans* fat, and cholesterol.



If someone is having a heart attack or stroke, call 9-1-1 right away.

♥  
**FREE  
SPACE**

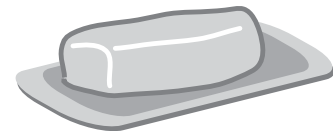

Saturated fat is found in high-fat meat, cheese, milk, and butter.



A blood pressure reading of 140/90 millimeters of mercury (mmHg) or greater is high blood pressure.



People with diabetes are at risk for heart disease or stroke.



Pregnant women should not smoke.



# Heart Health Bingo Card 14

## Heart Health Bingo



Protect your heart. When the heart stops, life stops.



If you are prescribed blood pressure or cholesterol medication, take it as the doctor tells you.



High blood pressure makes your heart work harder.

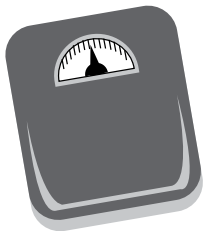

Being overweight increases your risk of high blood pressure, high blood cholesterol, and diabetes.



**FREE  
SPACE**



When eating out or at home, have baked, steamed, broiled, or grilled foods to cut down on fat and calories.



A desirable LDL (“bad”) blood cholesterol level is below 100 milligrams per deciliter (mg/dL).



Nonsmokers exposed to secondhand smoke increase their risk of developing heart disease by 25 percent to 30 percent.



Prediabetes means that you are at risk for developing type 2 diabetes. Act now—lose weight if overweight, and become active.

# Heart Health Bingo Card 15

## Heart Health Bingo



Trim visible fat from meat before cooking.

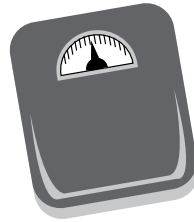

Being overweight increases your risk for heart disease and diabetes.

Nutrition Facts	
Serving Size 1 oz	
Servings Per Container 7	
Amount Per Serving	
Calories 120	Calories from Fat 90
% Daily Value*	
Total Fat 10g	15%
Saturated Fat 7g	35%
Trans Fat 0g	
Cholesterol 30mg	10%
Sodium 180mg	8%
Total Carbohydrate 1g	0%
Dietary Fiber 0g	0%
Sugars 0g	
Protein 6g	
Vitamin A 6%	Vitamin C 0%
Calcium 20%	Iron 0%

The Nutrition Facts label gives the serving size and the number of calories in a serving.

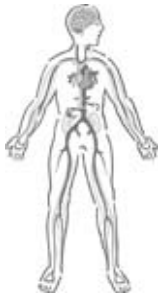

Warning signs of a stroke are numbness of the face, arm, or leg; confusion; trouble seeing; trouble walking; dizziness; and severe headache.



**FREE  
SPACE**



The signs of diabetes are increased thirst, hunger, and urination; fatigue; weight loss; blurred vision; and sores that don't heal.



A healthy triglyceride level is below 150 milligrams per deciliter (mg/dL).

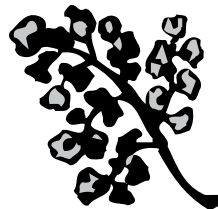

Use herbs and spices instead of salt.



Drain meat after it is cooked to get rid of some of the fat.

# Letter to Myself: Sample

I have learned that I can do many things to improve my health and lower my risk of developing heart disease. I can help my family members make healthy choices, too. During the next 3 months, I will try to do these things to care for my heart:

1. At work, I will use the stairs instead of taking the elevator.

---

---

2. I will eat 2 cups of fruit (an orange and an apple) every day.

---

---

3. When eating out, I will choose foods that are baked, broiled, or grilled.

---

---

4. I will switch to reduced-fat (2%) milk for 1 month, then to low-fat (1%) milk for 1 month, and finally to fat-free milk.

---

---

5. I will have my blood pressure checked at the local clinic.

---

---

Signed Robert Hall

Date 8/15/2007

# Letter to Myself

---

I have learned that I can do many things to improve my health and lower my risk of developing heart disease. I can help my family make healthy choices, too. During the next 3 months, I will try to do these things to care for my heart:

1. \_\_\_\_\_  
\_\_\_\_\_  
\_\_\_\_\_

2. \_\_\_\_\_  
\_\_\_\_\_  
\_\_\_\_\_

3. \_\_\_\_\_  
\_\_\_\_\_  
\_\_\_\_\_

4. \_\_\_\_\_  
\_\_\_\_\_  
\_\_\_\_\_

5. \_\_\_\_\_  
\_\_\_\_\_  
\_\_\_\_\_

Signed \_\_\_\_\_

Date \_\_\_\_\_

# Certificate of Achievement

Awarded to:

\_\_\_\_\_

For Completing the  
*Healthy Heart, Healthy Family Training*

Date

\_\_\_\_\_ Community Health Worker



U.S. Department of Health and Human Services  
National Institutes of Health



National Heart  
Lung and Blood Institute  
People Science Health



# Sertipiko ng Pagkamit

Inihahandog kay:

\_\_\_\_\_  
Para sa pagtatapos sa Malusog na Puso,  
Malusog na Pamilya na Pagsasanay

Petsa



U.S. Department of Health and Human Services  
National Institutes of Health

Manggagawa sa Pamayanan ng Kalusugan



National Heart  
Lung and Blood Institute  
People Science Health

# Lola's Favorite Proverbs

<b>Salawikain</b> (Proverb)	<b>English Translation</b>
1. <i>Ang karunungan ay kayamanan mo, na di maaring manakaw sa iyo.</i>	1. Knowledge is wealth that cannot be stolen.
2. <i>Aanhin pa ang damo, kung patay na ang kabayo.</i>	2. What good is the grass if the horse is already dead?
3. <i>Kung ano ang ginawa mo, ay siya ring bablik sa'yo.</i>	3. The act of self goes back to self.
4. <i>Walang mahirap na gawa pag dinaan sa tiyaga.</i>	4. No undertaking is difficult if pursued with perseverance.
5. <i>Jung may tinanim, may aanihin.</i>	5. If you plant, you will harvest.
6. <i>Huli man daw at magaling, naihabol din.</i>	6. It is never too late to offer anything that is good.
7. <i>Bilisan mo ang gawain. Hinay-hinay sa pagkain.</i>	7. If it's work, do it fast. If it's food, eat little by little.
8. <i>Kung ang isa ay hindi makapag disisyon, siya ay walang kinabukasan.</i>	8. One who cannot decide will have no future.
9. <i>Ang buhay ay parang gulong minsang nasa ibabaw, minsang nasa ilalim.</i>	9. Life is like a wheel; sometimes you are on top, sometimes you are on the bottom.
10. <i>Ang umaayaw ay di nagwawagi, ang nagwawagi ay di umaayaw.</i>	10. A quitter never wins; a winner never quits.
11. <i>Sa taong walang takot, walang mataas na bakod.</i>	11. To a fearless person, no fence is too high.
12. <i>Ang mabigat ay gumagaan, kung pinatutulngan.</i>	12. A heavy burden is lightened if everyone participates in carrying it.
13. <i>Ang taong matalino ay hindi tumitingin sa pagyapak ng paa niya sa lupa. Binabantayan niya ang kanyang kasunod na hakbang.</i>	13. A wise man does not see his foot on the ground; he watches his next step.
14. <i>Kung walang usok, wala ring apoy.</i>	14. There is no smoke where there is no fire.
15. <i>Walang tagumpay, kung walang paghihirap.</i>	15. There is no success if there is no sacrifice.
16. <i>Ang hindi marunog tumingin sa pinamggaligon, ay hindi makararating sa patuntunguhan.</i>	16. Those who do not know how to look back at where they came from will never get to their destinations.

\* *Salawikain* (proverbs) are an important part of Filipino culture. Most often said by elders, these sayings are passed down from generation to generation. Life lessons, jokes, and philosophies are echoed in these words. They are most often said in conjunction with another proverb to impart wisdom.

# Use Evaluation To Track Your Progress (Especially for Community Health Workers)

---

## Objectives

By the end of this session, community health workers will learn how to:

- Create a vision for a Healthy Heart, Healthy Family community project.
- Learn the basics of evaluation.
- Choose strategies that can be used to implement the Healthy Heart, Healthy Family project in the community.
- Learn the role of a community health worker in the evaluation process.
- Collect data to show the results of the project.
- Participate as a team member in the project's evaluation process.
- Create an evaluation workplan for the project's activities.

---

## Materials and Supplies

To conduct this session, you will need:

- “Healthy Heart, Healthy Family” manual and picture cards
- Blackboard and chalk or large pieces of paper, markers, and tape



- Color markers and sheets of poster board
  - “Healthy Heart, Healthy Family: Three Strategies To Offer in Your Community” (pages 462–464)
  - “Outcome Evaluation Form” (page 465)
- 

## **Handouts**

### **Give these handouts to each group member during the session:**

- “Examples of Project Evaluation” (pages 459–460)
  - “Types of Evaluation” (page 461)
  - “Community Health Worker Train the Trainer Pretest and Posttest (pages 466–470)
  - “Feedback Form—What Did You Think About the Training?” (pages 471–472)
  - “My Health Habits Pretest and Posttest” (pages 473–480)
  - “Screening Form” (page 481)
  - “Clinical Measures and Followup Form” (pages 482–485)
  - “Community Health Worker Activities Form” (pages 486–487)
  - “Recording Log (for Strategies 1, 2a, 2b, and 3)” (pages 488–490)
  - “Develop an Evaluation Workplan for Your Project” (pages 491–493)
- 

## **Session Outline**

### **Introducing the Session**

1. Welcome
2. About the Session

## Conducting the Session

1. Develop a Vision for a Healthy Heart, Healthy Family Community Project
2. Basic Information on Evaluation
3. Healthy Heart, Healthy Family: Three Strategies To Offer in Your Community
4. Data Collection
5. The Role of Community Health Workers in the Evaluation Process
6. How To Work as a Member of the Evaluation Team
7. Group Activity: Develop an Evaluation Workplan for Your Project

## Review of Today's Key Points

## Closing

# Introducing the Session

---

## 1. Welcome

- Welcome group members to the session.

## 2. About the Session

- Say:

You have learned a lot of information during this training. You have gained new skills and shown great progress and motivation. Now, you are ready to put the Healthy Heart, Healthy Family training into action in your community. Congratulations!

■ **Say:**

This session is especially for community health workers. It will teach you how to participate as a team member in the evaluation of your project.

## Conducting the Session

---

### **1. Develop a Vision for a Healthy Heart, Healthy Family Community Project**

■ **Say:**

During this session, you will develop a vision for a Healthy Heart, Healthy Family community project.

■ **Ask:**

Can someone tell me what a vision is?



**Note:** Allow 2 to 3 minutes for group members to respond. Write their answers on the blackboard or a large piece of paper taped to the wall.

■ **Add** the following answers if they are not mentioned:

- A vision is your dream, an image, or a picture of what you want to do and what you imagine your community project will do for the people you serve.
- It is the direction or goal of your project.
- It is what inspires, motivates, and engages people to take action.

■ **Say:**

A vision can be written as a statement or expressed as a drawing.

Some examples of vision statements are:

- A heart healthy and stroke-free community
- An active, healthy, and informed community

■ **Say:**

Now it's time for you to create a vision for a community project. Think of this question when you create your vision: What would you like your community to be like after implementing your heart health project?

**Note:** Divide the participants into small groups.

■ **Say:**

Choose one person from your group to share your group's vision.



**Note:** Give each small group a set of color markers and a piece of poster board. Allow 20 minutes for the groups to come up with their visions.

■ **Say:**

Now, a member of each group will present each vision to the rest of the group members.



**Note:** Allow 2 to 3 minutes for each group to share its vision. Congratulate the community health workers for their enthusiasm and a job well done.

## 2. Basic Information on Evaluation

■ **Say:**

When you offer the Healthy Heart, Healthy Family classes in your community, you will want to know if your project helped you achieve your vision. Evaluation can help you do this. Now, let's talk about what evaluation is and some important steps you need to know when you evaluate a project.

■ **Say:**

Evaluation is a well-thought-out process to assess the value of your project.

■ **Ask:**

What are the benefits of evaluation?



**Note:** Allow about 2 minutes for group members to answer. Write their answers on the blackboard or on a large piece of paper taped to the wall.

■ **Add** the following answers if they are not mentioned.

Evaluation offers you a way to:

- Find out if your project is working or is successful.
- Learn whether you are meeting the goals of the project.
- Find out which project areas need to be changed or improved.
- Gather information about your project that you can share with the community and those who fund your project.
- Learn whether your project activities are helping people make healthy choices.

■ **Give** each group member the “Examples of Project Evaluation” handout (pages 459–460).



■ **Say:**

Now we will look at how evaluation is used in a few projects.

■ **Ask** volunteers to read aloud each example and tip.

## Example 1

During the month of May, doctors from a community clinic referred 45 patients to the heart health sessions conducted by community health workers. Thirty participants attended all of the heart health sessions. The other 15 participants only attended a few sessions.

After the classes ended, the community health workers conducted followup visits. These visits revealed that the 30 participants who attended all the classes were using the project's heart healthy recipes, participating in physical activities, and taking their medication(s) as the doctor told them. The other 15 participants who did not attend all the classes were not using the recipes, most were not doing any physical activity, and several were taking their medication(s) only when they remembered.

The community health workers saw that the project had a greater positive impact on participants who took part in all of the heart health sessions.

**Tip:** Plan to track participants at every stage of your project: (1) referrals, (2) class attendance, and (3) followup after the classes.

## Example 2

A community health worker is a member of the health-promotion team working on a project to increase the physical activity of community members. Participants attended a series of heart health sessions. The community health worker reviewed the results of the project and found that 15 out of 20 participants who went to at least 6 of the training sessions were now walking 30 minutes or more per day.

The community health worker learned that people who attended the heart healthy sessions increased their physical activity.

**Tip:** Learn your project goals; review them throughout your project. Make sure that project activities make sense and are helping to reach the goals of the project.

### **Example 3**

A group of community health workers posted flyers in the community telling people about an upcoming cholesterol screening. They held the screening, but only a few people showed up. After the poor turnout, the community health workers thought about different ways to get the word out. They met with community leaders, got their input, and developed a new strategy. The new strategy was to go door to door to talk about the importance of cholesterol screening and to ask people to share this information with friends and family. The community health workers held a second screening and had a much better turnout.

By finding out what did not work and getting input from the community, the community health workers were able to make changes in the way they recruited participants.

**Tip:** Do not focus only on the positive results of the project. You can learn a great deal by looking at what went wrong and what did not work.

### **Example 4**

A community health worker conducted several heart healthy sessions for community members. One participant shared her high blood pressure story. She described how her doctor had told her she had high blood pressure and about all the healthy changes she had made since then. After 3 months, she had lost 10 pounds and her blood pressure was under control.

The community health worker asked this participant to share her story at a community gathering. More community members are now interested in taking part in the heart healthy sessions.

**Tip:** Be creative. Project evaluation is about more than just the numbers. Participants' stories, pictures, and journals can be very powerful demonstrations of the way your project has affected them.

## ■ Say:

You have learned examples of project evaluation. Let's go over the seven steps of creating a plan for implementing and evaluating your project.

1. **Choose the activities.** Work with your agency to choose the activities you want to include. For example, your project may offer to train community health workers using the “Healthy Heart, Healthy Family” manual.
2. **Implement project activities.** Perform the activities of your project as planned. For example, you can recruit 20 community health workers from the community and conduct the Healthy Heart, Healthy Family project.
3. **Collect data.** Collect data to show whether your project is helping community health workers. For example, you can use questionnaires to find out how community health workers used the information, what they learned in the sessions, and if they made heart healthy changes in their lives.
4. **Enter data.** Enter information from the completed questionnaires into a database. This task can be done by trained community health workers or trained project staff.
5. **Analyze the data.** An evaluator can analyze the data and summarize the findings. For example, an evaluator may find that community health workers who walk for 60 minutes daily have lower blood pressure and have lost weight.
6. **Write a report about the results of the project.** A report can show how the community has changed as a result of the project. For example, the evaluator may describe how community health workers' eating habits and physical activity patterns have changed as a result of their participation in the Healthy Heart, Healthy Family project.
7. **Share the results of your project with others.** Community health workers can share results with community members. Sharing results can increase community members' interest in the project and motivate them to take personal action to improve their health.



■ **Say:**

You have seen how evaluation can help you. Now, let's take a look at two types of evaluation: process evaluation and outcome evaluation.

- **Give** each group member the “Types of Evaluation” handout (page 461).

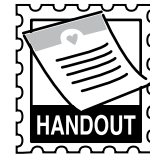

- **Ask** volunteers to read aloud the types of evaluation and each example.

## Types of Evaluation

### Process Evaluation

Process evaluation tells you about the content of project activities. You can learn whether you are doing the activities as they are planned. It also tells you who is participating in your project activities. You can track the specifics of the way you carry out your project, such as the time spent on activities and how many participants attended the activities. The results of process evaluation help you discover which activities are more successful than others. It also gives you the feedback you need to improve your project.

**Example:** You can collect information about the number of sessions you taught from the “Healthy Heart, Healthy Family” manual and how much time you spent on activities during the training sessions.

### Outcome Evaluation

Outcome evaluation describes the effect your project had on participants. You can learn how the participants changed or are changing after completing the course. You can track how participants’ knowledge, feelings (attitudes), or actions (behaviors) have changed after taking part in the project. You can also note the changes in the clinical values. (For example, you can check to see if participants’ blood pressure or weight has decreased).

**Example:** A questionnaire is given to participants before the first class. The same questionnaire is given after the last class. The results of the two tests are compared. This will tell you how much the participants learned.

### Other Evaluation Methods

You can use other methods to evaluate your project. You can ask participants for their stories (testimonials) about how the course has affected them and collect the stories as the project evolves. They can submit photographs and journals about the changes they have made during the project.

### 3. Healthy Heart, Healthy Family: Three Strategies To Offer in Your Community



**Note:** Before the session, read the charts on pages 462–464 that serve as a guide. These charts describe the three strategies in more detail. Each strategy includes: goals, description of activities, setting, and target audience.

#### ■ Say:

You can offer the Healthy Heart, Healthy Family training in your community using three strategies. These strategies are:

1. **Train the Trainer.** This strategy consists of using the “Healthy Heart, Healthy Family” manual to train a group of community health workers, who will then go back to their communities and train other community health workers.
2. **Community Education.** In this strategy, trained community health workers use the “Healthy Heart, Healthy Family” manual and picture cards to teach community members by using one of the following options:
  - Teaching all the lessons from the manual to community members.
  - Teaching all the lessons of the manual and screening community members. Screenings can include: the height, weight, and waist measures of the participants. Blood pressure, blood cholesterol, and blood glucose screenings can also be conducted with the help of other agencies and health professionals. If needed, community health workers can refer project participants with elevated values to a medical setting for followup.

#### ■ Ask:

When you do screenings as part of your community education, why do you think it is necessary to partner with other agencies such as clinics?



**Note:** Allow about 2 minutes for group members to respond.



**Note:** Add the following answers if they are not said:

- To secure trained health care staff to screen participants for high blood pressure, high blood cholesterol, or high blood glucose. This person usually works in a clinic or hospital.
- To get an authorized agency to obtain permission forms from participants before they are screened for high blood pressure, high blood cholesterol, or high blood glucose.
- To refer participants with elevated numbers to a health care professional at the clinic to confirm that their levels are high and to get health information.

3. **Lifestyle and Clinical Management.** In this strategy, community health workers function as part of the health care team. Trained community health workers: (1) teach sessions of the manual to patients, (2) monitor patients' clinical measures (blood pressure, blood cholesterol, body mass index [BMI], waist measures, and blood glucose levels) in collaboration with a health care provider, (3) and follow up with patients to offer support and encouragement in addition to making sure that patients are following their treatment.

■ **Ask:**

Does anyone have questions about the strategies?



**Note:** Allow 2 minutes for group members to respond.

## 4. Data Collection



**Note:** Before the session, read the charts on page 465 that serve as a guide. The outcome evaluation chart describes each strategy, the forms needed to collect outcome data for each strategy, when the forms should be used, and the type of information you can collect to evaluate your project.

■ **Say:**

Once you have figured out which strategy or strategies you want to offer in your community, you need to collect data for each strategy. For the “Healthy Heart, Healthy Family” manual, data collection forms for the three strategies are included at the end of this session.



**Note:** Give group members copies of the data collection forms, and describe each form. The data collection forms are:



- “Community Health Worker Train the Trainer Pretest and Posttest” (pages 466–470)
- “Feedback Form—What Did You Think About the Training?” (pages 471–472)
- “My Health Habits Pretest and Posttest” (pages 473–480)
- “Screening Form” (page 481)
- “Clinical Measures and Followup Form” (pages 482–485)
- “Community Health Worker Activities Form” (page 486–487)
- “Recording Log Form (for Strategies 1, 2a, 2b, and 3)” (pages 488–490)

■ **Say:**

Let’s look at the data collection forms for the three strategies. We will start with the **Train the Trainer** strategy. This strategy uses the “Community Health Worker Train the Trainer Pretest and Posttest” forms. The pretest form was used at the beginning of the training, and you will use the posttest form at the end of the training.

The changes in the responses from pretest to posttest will help you find out if you learned new information or skills. After the training, you will also complete the “Feedback Form—What Did You Think About The Training?” questionnaire. This form provides information on your likes and dislikes concerning the training, on how confident you feel about training others, and suggestions for improving the training.

■ **Say:**

For the second strategy—**Community Education**—you will use the “My Health Habits Pretest and Posttest” forms to find out if participants are changing their health habits. If you add screenings to your community education strategy, you can use the “Screening Form” to record the clinical values of your project participants.

■ **Say:**

Using the third strategy—**Lifestyle and Clinical Management**—you can use the “My Health Habits Pretest and Posttest” to find out how patients are changing their health habits. You can also use the “Clinical Measures and Followup Form” to record the patients’ changes in values.

The “Community Health Workers Activities Form” can be used to keep track of the followup activities that help patients stay on their treatment plan.

■ **Say:**

The “Clinical Measures and Followup Form” is useful for community health workers who work in a clinical setting.

■ **Ask:**

How many of you work in a clinic, hospital, or other medical setting?



**Note:** Allow 2 minutes for group members to respond.

■ **Say:**

When you work with patients, it is very important to keep track of the followup activities to help patients stay on the medication(s) prescribed by their doctors. You should also keep track of your followup activities to help patients make lifestyle changes.



**Note:** Since you have already reviewed the “Community Health Workers Activities Form” handout, ask volunteers if they have any questions or comments about the activities listed on the handout. Allow 2 minutes for group members to respond.

■ **Say:**

Collecting information on followup activities can highlight the important role community health workers have in helping patients stay on their treatment plans and control their risk factors.

■ **Say:**

The last form that we will talk about is the “Recording Log.” This log tells you which form to use for each strategy and tells you what type of information to gather for each strategy. The recording log focuses on process evaluation activities.

■ **Say:**

Let’s review the “Recording Log” handout. The information you will gather for the Train the Trainer strategy is:

- Number of participants trained
- Number of sessions taught
- Number and percentage of participants who rate the training as “good” or better
- Number and percentage of participants who report that they “will” or “most likely will” change their health habits
- Number of participants using the “Healthy Heart, Healthy Family” manual 30 days after the training
- Types of activities that participants are completing 30 days after the training

■ **Ask** a volunteer to read aloud the information for the community education strategy.

■ **Ask** a volunteer to read aloud the information for the lifestyle and clinical management strategy.

■ **Say:**

Does anyone have questions?

■ **Say:**

The “Recording Log” form is important, because the results can tell you which activities are being implemented. It also gives you the feedback you need to improve your project.

## ■ Say:

Before using these data collection forms, we recommend that you review the “More Information” box below. This box contains tips for gathering information for your community project.

### More Information

Tips for gathering information for your community project.

#### Before you offer a questionnaire to others:

- Check with your agency. Your agency may need to approve the questionnaire before you use it. Privacy and the consent of the project participants are important when doing evaluation. You will want to follow the policies of your organization and your funding agency.
- Make sure you understand how to fill out the questionnaire before you hand it out. Know the form well so you can answer any questions participants may have.

#### The day of filling out the survey:

- Bring plenty of forms and pens with you.
- Ask participants to answer each question completely. Missing information will make it difficult for you to analyze the data.
- If the budget allows, give a small gift to people who sign up for the course or fill out your form.
- Always remember to thank participants.



**Note:** During the pretest and posttest, the community health workers or volunteers may ask the questions aloud if people need help with their forms. Questions may be read aloud, but the answers to the questions should not be given.

## 5. The Role of Community Health Workers in the Evaluation Process

### ■ Ask:

Has anyone already worked on the evaluation of a project? Can you share what you did?



**Note:** Allow 3 minutes for group members to respond.

### ■ Say:

Some of you may be thinking that evaluation is too complicated and that there is no role for you. But that is not true. Here are some examples of the roles that community health workers can have in the evaluation process.

Community health workers can:

- Help decide which activities should be conducted.
- Hand out questionnaires and other instruments to participants.
- Collect the forms.
- Enter data into a computer.
- Provide feedback on what worked, what did not work, and how the activities can be improved.
- Share results of the evaluation with the community.
- Attend training meetings about project evaluation.

### ■ Say:

Remember that your involvement in the evaluation process can help show the value of having community health workers on the project team. The actions of community health workers are key in tracking project activities in the community.



■ **Say:**

If you have not been part of an evaluation team, would you be interested in having a role in the evaluation process of Healthy Heart, Healthy Family?



**Note:** Allow 5 minutes for group members to respond.

■ **Say:**

Thank you for sharing your experience being part of an evaluation team. With time and practice, your confidence level will increase. Just as you have been trained to conduct the sessions of the “Healthy Heart, Healthy Family” manual, you will be trained to conduct evaluation activities for your project. In less time than you think, you will be making great contributions to your evaluation team.

## **6. How To Work as a Member of the Evaluation Team**

■ **Say:**

People who evaluate projects need to work as a team. Community health workers can be an important part of that team.

■ **Say:**

A community project team may include:

- A project manager
- An evaluator
- Community health workers
- Health professionals

■ **Ask:**

Do you have an evaluator on your project team or in your agency?



**Note:** Allow 2 minutes for group members to respond.

■ **Ask:**

What are some things you can do to get involved with project evaluation when you return to your agency?



**Note:** Allow 2 to 3 minutes for group members to respond. **Write** their responses on the blackboard or a large piece of paper taped to the wall.

■ **Add** any of the following answers if they are not said.

Community health workers can:

- Find out who does evaluations in their agencies.
- Share this session on evaluation with their supervisors.
- Ask their supervisors how they may be involved in evaluating the project.
- Ask their supervisors if they may attend trainings on project evaluation.

■ **Say:**

If your agency does not have an evaluator, you can try to link up with an outside evaluator who supports community health worker projects.

■ **Say:**

An evaluator can help to:

- Develop an evaluation plan for the project.
- Make sure that the project is carried out as intended.
- Conduct an analysis.
- Write a report on the data collected.

## More Information

Your agency can get the services of an outside evaluator by contacting:

- Other community health worker projects
- A university that has a school of public health or public health project
- A foundation that has community health projects and can refer you to an evaluation consultant
- Your State health department

## 7. Group Activity: Develop an Evaluation Workplan for Your Project



### ■ Say:

The purpose of this activity is to develop an evaluation workplan for a community project.

- **Divide** group members into the same three groups they were in when they developed the vision for their community projects. Give each group a different project from the “Develop an Evaluation Workplan for Your Project” handout (pages 491–493).

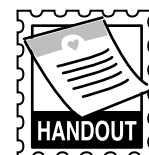

**Note:** Group 1 will work on project 1; group 2 will work on project 2; and group 3 will work on project 3.

### ■ Say:

This handout on evaluation includes the project descriptions and a blank chart with questions to help you develop a plan for evaluating your activities. The questions are:

1. Who will be your target audience?
2. What strategy will you use?

3. Which forms will you use to collect data for your project?
4. Describe the activities for carrying out the strategy:
  - How will you recruit participants?
  - When will you schedule the classes?
  - Who will teach the classes?
5. Decide who will manage the data:
  - Who will collect the data?
  - Who will enter the data?
  - Who will analyze the data?
6. Who will write the evaluation report for the project?



**Note:** Ask one person from each group to present the group's evaluation plan to the entire group. Allow about 5 minutes for the presentation.

■ **Say:**

Thank you for doing such a wonderful job!

## Community Projects



**Note:** Discuss your project and the evaluation workplan using the guide on pages 491–493.

### **Project 1: Training Community Health Workers To Promote the Healthy Heart, Healthy Family Project in Your Community**

- Your agency has agreed to conduct the Healthy Heart, Healthy Family Train the Trainer workshop for several agencies in the community. Your agency will train 25 community health workers who have asked to participate in the workshop.
- Your supervisor asks you and two other community health workers to plan the Train the Trainer workshop and to develop the evaluation plan.



**Note:** Discuss your project and the evaluation workplan using the guide on pages 491–493.

### **Project 2: Helping Community Members Make Heart Healthy Lifestyle Changes**

- Your community-based organization is in Queens, New York.
- Your supervisor asks you to help develop the evaluation plan for the Healthy Heart, Healthy Family community education project.
- The course is for adults aged 30 to 60.
- The goal is to recruit, teach, and increase the knowledge, positive attitudes, and skills of the community members attending your classes.



**Note:** Discuss your project and the evaluation workplan using the guide on pages 491–493.

### **Project 3: Helping Patients Manage Their Risk Factors for Heart Disease and Make Lifestyle Changes**

- Your clinic is located in Honolulu, Hawaii.
- Your clinic has decided to get involved in a project on heart health to help patients change their behavior and lower their clinical measures.
- You and two other community health workers attended a community health workers' conference to receive the Healthy Heart, Healthy Family training.
- Now, your supervisor wants your group to develop activities and an evaluation plan for the project.



**Note:** Allow about 30 minutes for each group to come up with their evaluation plans.

# Review of Today's Key Points

---

## ■ Say:

Let's review what we learned today.

### **What is evaluation?**

- Evaluation is a well-thought-out process for assessing the value of your project. Through the evaluation process, you will learn whether you are meeting the goals of the project.

### **What are the benefits of evaluation?**

- Finding out if your project is working as planned, or is successful.
- Learning whether you are meeting the goals of the project.
- Discovering which project areas need to be changed or improved.
- Gathering information about your project that you can share with the community and those who fund your project.
- Learning whether your project activities are helping people make healthy choices.

### **What is the role of community health workers in the evaluation process?**

- Helping to decide which activities should be carried out.
- Administering questionnaires and other instruments.
- Collecting the instruments.
- Entering data into computers.
- Providing feedback on the ways the activities are carried out and how they can be improved.

- Sharing results of the evaluation with the community.
- Attending training meetings about project evaluation.

### **What can you evaluate using the “Healthy Heart, Healthy Family” manual?**

- You can evaluate the training of community health workers for promoting heart health in the community.
- You can evaluate what community members have learned and which changes they have made to have heart healthy lifestyles.
- You can evaluate how patients have been helped in managing their risk factors for heart disease and making changes in their lifestyles.

### **Who forms the community project team for evaluation?**

- A project manager
- An evaluator
- Community health workers
- Health professionals

## Closing

---

### ■ Say:

Thank you for coming today. What did you think of today’s session?



**Note:** Allow a moment for group members to respond.

### ■ Say:

Community health workers play an important role in the evaluation of a community project. We hope this session helps you achieve positive results in your work with the community. I wish you success in implementing the Healthy Heart, Healthy Family project in your community.

# Examples of Project Evaluation

## Example 1

During the month of May, doctors from a community clinic referred 45 patients to the heart health session conducted by community health workers. Thirty participants attended all of the heart health sessions. The other 15 participants attended only a few sessions.

After the classes ended, the community health workers conducted followup visits. These visits revealed that the 30 participants who attended all the classes were using the project's heart healthy recipes, participating in physical activities, and taking their medication(s) as the doctor told them. The other 15 participants who did not attend all the classes were not using the recipes, most were not doing any physical activity, and several were taking their medication(s) only when they remembered.

The community health workers saw that the project had a greater positive impact on participants who took part in all of the heart health sessions.

**Tip:** Plan to track participants at every stage of your project – (1) referrals, (2) class attendance, and (3) followup after the classes.

## Example 2

A community health worker is a member of the health promotion team working on a project to increase the physical activity of community members. Participants attended a series of heart health sessions. The community health workers reviewed the results of the project and found that 15 out of 20 participants who went to at least 6 of the training sessions were now walking 30 minutes or more per day. The community health worker learned that the people who attended the heart healthy sessions increased their physical activity.

**Tip:** Learn your project goals; review them throughout your project. Make sure that project activities make sense and are helping you to reach the goals of the project.



## Examples of Project Evaluation *(continued)*

### Example 3

A group of community health workers posted flyers in the community announcing an upcoming cholesterol screening. They held the screening, but only a few people showed up. After the poor turnout, the community health workers thought about other ways to get the word out. They met with community leaders, got their input, and developed a new strategy. The new strategy was to go door to door to talk about the importance of cholesterol screening and to ask people to share this information with friends and family. The community health educators held a second screening and had a much better turnout.

By finding out what did not work and getting input from the community, the community health workers were able to make changes in the way they recruited participants.

**Tip:** Do not focus only on the positive results of the project. You can learn a great deal by looking at what went wrong and what did not work.

### Example 4

A community health worker conducted several heart healthy sessions for community members. One participant shared her high blood pressure story. She described how her doctor had told her she had high blood pressure and about all the healthy changes she had made since then. After 3 months, she had lost 10 pounds and her blood pressure was under control.

The community health worker asked this participant to share her story at a community gathering. More community members are now interested in taking part in the heart healthy sessions.

**Tip:** Be creative. Project evaluation is about more than just the numbers. Participants' stories, pictures, and journals can be very powerful demonstrations of the way your project has affected them.

# Types of Evaluation

## **Process Evaluation**

Process evaluation tells you about the content of project activities. You can learn whether you are doing the activities as they are planned. It also lets you know who is participating in your project activities. You can track the specifics of how you carry out your project, such as the time spent on activities and how many participants attended them. The results of process evaluation show you which activities are more successful than others. It also gives you the feedback you need to improve your project.

**Example:** You can collect information about the number of sessions you taught from the “Healthy Heart, Healthy Family” manual and how much time you spent on activities during the training sessions.

## **Outcome Evaluation**

Outcome evaluation describes the effect your project had on the participants. You can learn how the participants changed or are changing after completing the course. You can track how their knowledge, feelings (attitudes), or actions (behaviors) have changed after taking part in the project. You can also note the changes in the clinical values. (For example, you can see if participants’ blood pressure or weight has decreased).

**Example:** A questionnaire is given to participants before the first class. The same questionnaire is given after the last class. The results of the two tests are compared. This will tell you how much the participants learned.

## **Other Evaluation Methods**

You can use other methods to evaluate your project. You can ask participants for their stories (testimonials) about how the course has affected them and collect the stories as the project evolves. They can submit photographs and journals that demonstrate the changes they have made during the project.

# Healthy Heart, Healthy Family: Three Strategies To Offer in Your Community

Strategy	Goals	Description of Activities	Settings	Target Audience
<p><b>1. Train the Trainer</b></p>	<ul style="list-style-type: none"> <li>• Increase the number of community health workers who are prepared to train others.</li> <li>• Increase the use of the “Healthy Heart, Healthy Family” manual by trained community health workers.</li> <li>• Increase knowledge about heart health.</li> <li>• Increase positive attitudes and behaviors toward a healthy lifestyle.</li> <li>• Increase the ability to identify risk factors for cardiovascular disease in participants.</li> </ul>	<p>Trained community health workers train others by:</p> <ul style="list-style-type: none"> <li>• Recruiting community health workers</li> <li>• Teaching the “Healthy Heart, Healthy Family” manual to other community health workers</li> <li>• Administering the pretest and posttest</li> <li>• Following up to make sure that trained community health workers are using the manual</li> </ul>	<p>Clinical and nonclinical:</p> <ul style="list-style-type: none"> <li>• Community-based organizations (CBOs)</li> <li>• Clinics</li> <li>• Hospitals</li> <li>• Public health programs</li> </ul>	<ul style="list-style-type: none"> <li>• Community health workers</li> <li>• Other health professionals, for example, nurses, registered dietitians, nutritionists, and public health educators</li> </ul>

# Healthy Heart, Healthy Family: Three Strategies To Offer in Your Community *(continued)*

Strategy	Goals	Description of Activities	Settings	Target Audience
<p><b>2. Community Education</b></p> <p><b>a. Teach the educational manual only.</b></p>	<ul style="list-style-type: none"> <li>• Increase knowledge about heart health.</li> <li>• Increase positive attitudes toward making lifestyle changes.</li> <li>• Increase the adoption of healthy lifestyle behaviors.</li> </ul>	<p>Trained community health workers who work in nonclinical settings:</p> <ul style="list-style-type: none"> <li>• Recruit members of the community.</li> <li>• Teach the “Healthy Heart, Healthy Family” manual.</li> <li>• Administer the “My Health Habits Pretest and Posttest.”</li> </ul>	<p>Nonclinical:</p> <ul style="list-style-type: none"> <li>• Community-based organizations</li> <li>• Resource centers</li> <li>• Homes</li> <li>• Schools</li> <li>• Faith-based organizations</li> <li>• Senior centers</li> </ul>	<ul style="list-style-type: none"> <li>• Families and community members with signed informed consent</li> </ul>
<p><b>b. Teach the educational manual and screen project participants.</b></p>	<ul style="list-style-type: none"> <li>• Increase knowledge about heart health.</li> <li>• Increase positive attitudes toward making lifestyle changes.</li> <li>• Increase the adoption of healthy lifestyle behaviors.</li> <li>• Track participants’ clinical data.</li> <li>• Refer participants with elevated levels to health care professionals to verify if levels are high.</li> </ul>	<p>Trained community health workers working in nonclinical settings:</p> <ul style="list-style-type: none"> <li>• Recruit members of the community.</li> <li>• Teach the “Healthy Heart, Healthy Family” manual.</li> <li>• Administer the “My Health Habits Pretest and Posttest.”</li> <li>• Take height, weight, and waist measures.</li> <li>• Measure participants’ blood pressure, blood cholesterol, and blood glucose levels.</li> <li>• Refer individuals with elevated clinical measures to health care professionals to confirm their levels are high.</li> </ul>	<ul style="list-style-type: none"> <li>• Nonclinical in partnership with a health care professional</li> </ul>	<ul style="list-style-type: none"> <li>• Families and community members with signed informed consent</li> </ul>

# Healthy Heart, Healthy Family: Three Strategies To Offer in Your Community *(continued)*

Strategy	Goals	Description of Activities	Settings	Target Audience
<p><b>3. Lifestyle and Clinical Management</b></p>	<ul style="list-style-type: none"> <li>• Increase knowledge about heart health.</li> <li>• Increase positive attitudes toward making lifestyle changes.</li> <li>• Increase adoption of healthy lifestyle behaviors.</li> <li>• Lower body mass index (BMI), high blood pressure, high blood cholesterol, and high blood glucose.</li> </ul>	<p>Trained community health workers who act as members of the health care team:</p> <ul style="list-style-type: none"> <li>• Teach the “Healthy Heart, Healthy Family” manual to patients with heart disease risk factors and to patients who are interested in learning about heart health.</li> <li>• Administer the “My Health Habits Pretest and Posttest.”</li> <li>• Take patients’ height, weight, and waist measures.</li> <li>• Work with health care professionals to track patients’ blood pressure, blood cholesterol, and blood glucose levels.</li> <li>• Follow up through home visits and phone calls to make sure patients are following their treatment plans and making lifestyle changes.</li> <li>• Provide social support and encouragement.</li> </ul>	<ul style="list-style-type: none"> <li>• Clinics</li> <li>• Hospitals</li> <li>• Managed-care programs</li> <li>• Health centers</li> <li>• Private doctors’ offices</li> <li>• Health departments</li> </ul>	<ul style="list-style-type: none"> <li>• Patients with heart disease risk factors</li> <li>• Patients interested in learning about heart health</li> </ul>

# Outcome Evaluation Form

Strategy	Forms	Use This Form	Outcome Evaluation
1. Train the Trainer	Community Health Worker Train the Trainer Pretest and Posttest	<ul style="list-style-type: none"> <li>• Before and after the training</li> </ul>	<ul style="list-style-type: none"> <li>• Number and percentage of participants who change their knowledge levels and attitudes</li> </ul>
	My Health Habits Pretest and Posttest	<ul style="list-style-type: none"> <li>• Before and after teaching the manual</li> </ul>	<ul style="list-style-type: none"> <li>• Number and percentage of participants who change knowledge, attitudes, and behaviors</li> </ul>
2. Community Education a. Teach the educational manual only. b. Teach the educational manual and screen project participants	My Health Habits Pretest and Posttest	<ul style="list-style-type: none"> <li>• Before and after teaching the manual</li> </ul>	<ul style="list-style-type: none"> <li>• Number and percentage of participants who change knowledge, attitudes, and behaviors</li> </ul>
	Screening Form	<ul style="list-style-type: none"> <li>• Before and after teaching the manual</li> </ul>	<ul style="list-style-type: none"> <li>• Number and percentage of participants referred to a health care professional</li> <li>• Number and percentage of participants who actually followed up with a health care professional</li> </ul>
3. Lifestyle and Clinical Management	My Health Habits Pretest and Posttest	<ul style="list-style-type: none"> <li>• Before and after delivering the manual</li> <li>• 12 months after collecting initial data (baseline data)</li> </ul>	<ul style="list-style-type: none"> <li>• Number and percentage of patients who change knowledge levels, attitudes, and behaviors</li> </ul>
	Clinical Measures and Followup	<ul style="list-style-type: none"> <li>• Before delivering the manual (baseline)</li> <li>• 6 months after baseline</li> <li>• 12 months after baseline</li> </ul>	<ul style="list-style-type: none"> <li>• Number and percentage of patients who change clinical values</li> <li>• Number and percentage of patients who are taking their medication(s)</li> </ul>
	Community Health Worker Activities Tracking Form	<ul style="list-style-type: none"> <li>• First followup encounter (after the manual is taught)</li> <li>• 3-month followup</li> <li>• 6-month followup</li> <li>• 12-month followup</li> </ul>	<ul style="list-style-type: none"> <li>• Number and percentage of patients contacted for followup</li> </ul>

# Community Health Worker Train the Trainer Pretest and Posttest

**FOR INTERNAL USE ONLY**  
(For Strategy 1)

Participant identification (ID) number: \_\_\_\_\_

Name of person teaching the manual: \_\_\_\_\_

Pretest Start Date (MM/DD/YYYY): \_\_\_\_/\_\_\_\_/\_\_\_\_

Posttest End Date (MM/DD/YYYY): \_\_\_\_/\_\_\_\_/\_\_\_\_

30-day followup Date of contact (MM/DD/YYYY): \_\_\_\_/\_\_\_\_/\_\_\_\_

Was the participant contacted 30 days after training ended for information about how he or she is using the “Healthy Heart, Healthy Family” manual? <sub>1</sub>Yes <sub>2</sub>No

What activities is the participant doing? \_\_\_\_\_

## **Participant Information**

Please give us some information about yourself by completing this form **before the training**. Ask for assistance if you need it.

1. Today’s date (MM/DD/YYYY): ____/____/____
2. Date of birth (MM/DD/YYYY): ____/____/____
3. Age (in years): _____
4. Gender: <input type="checkbox"/> <sub>1</sub> Male <input type="checkbox"/> <sub>2</sub> Female
5. (a) Place of birth: _____ City State Country
5. (b) If your place of birth is in the Philippines, the city is located in the: <input type="checkbox"/> <sub>1</sub> Northern Philippines <input type="checkbox"/> <sub>2</sub> Central Philippines <input type="checkbox"/> <sub>3</sub> Southern Philippines <input type="checkbox"/> <sub>4</sub> N/A
6. Do you consider yourself Latino or Hispanic? <input type="checkbox"/> <sub>1</sub> Yes <input type="checkbox"/> <sub>2</sub> No

# Community Health Worker Train the Trainer

## Pretest and Posttest *(continued)*

<p>7. Which race do you consider yourself to be?</p> <p><input type="checkbox"/><sub>1</sub> Alaska Native</p> <p><input type="checkbox"/><sub>2</sub> American Indian</p> <p><input type="checkbox"/><sub>3</sub> Asian</p> <p><input type="checkbox"/><sub>4</sub> Black or African American</p> <p><input type="checkbox"/><sub>5</sub> Native Hawaiian or other Pacific Islander</p> <p><input type="checkbox"/><sub>6</sub> White</p>	
<p>8. How many years of school have you completed (in the United States or in your country of origin)?</p> <p><input type="checkbox"/><sub>1</sub> Some primary school</p> <p><input type="checkbox"/><sub>2</sub> Completed primary school</p> <p><input type="checkbox"/><sub>3</sub> Some secondary school</p> <p><input type="checkbox"/><sub>4</sub> Graduated from secondary school or received high school equivalency diploma (GED)</p> <p><input type="checkbox"/><sub>5</sub> Some technical/vocational school</p> <p><input type="checkbox"/><sub>6</sub> Graduated from technical/vocational school</p> <p><input type="checkbox"/><sub>7</sub> Some college/university</p> <p><input type="checkbox"/><sub>8</sub> Graduated from college/university</p> <p><input type="checkbox"/><sub>9</sub> Some postgraduate</p> <p><input type="checkbox"/><sub>10</sub> Graduated from postgraduate school</p>	
<p>9. (a) Language you prefer:</p> <p><input type="checkbox"/><sub>1</sub> English    <input type="checkbox"/><sub>2</sub> Tagalog    <input type="checkbox"/><sub>3</sub> Both    <input type="checkbox"/><sub>4</sub> Other</p> <p>(b) If language is "Other," please name the language you prefer: _____</p>	
<p>10. Have you worked as a community health worker before?    <input type="checkbox"/><sub>1</sub> Yes    <input type="checkbox"/><sub>2</sub> No</p>	<p>11. If yes, for how long?</p> <p>_____ years    _____ months</p>
<p>12. What health topics have you taught? (You may select more than one answer.)</p> <p><input type="checkbox"/><sub>1</sub> None</p> <p><input type="checkbox"/><sub>2</sub> Asthma</p> <p><input type="checkbox"/><sub>3</sub> Diabetes</p> <p><input type="checkbox"/><sub>4</sub> Cancer</p> <p><input type="checkbox"/><sub>5</sub> HIV/AIDS</p> <p><input type="checkbox"/><sub>6</sub> Cardiovascular</p> <p><input type="checkbox"/><sub>7</sub> Others (please specify): _____</p>	
<p>13. Have you used manuals to counsel or teach community members?</p> <p><input type="checkbox"/><sub>1</sub> Yes    <input type="checkbox"/><sub>2</sub> No</p> <p>If yes, please write the name(s) of the manual(s) you have used.</p> <p>_____</p>	
<p>14. Is this your first training with the "Healthy Heart, Healthy Family" manual?    <input type="checkbox"/><sub>1</sub> Yes    <input type="checkbox"/><sub>2</sub> No</p>	



# Community Health Worker Train the Trainer

## Pretest and Posttest *(continued)*

---

Please circle only one answer for each question.

Lola (Mrs. Caradid de la Cruz), who is 73 years old, is Rose’s mother-in-law. Lola’s son, Jose, is married to Rose. Lola has a history of a BMI of 28 and high blood pressure—her blood pressure is 148/98 mmHg (millimeters of mercury). Her blood cholesterol is 250 mg/dL (milligrams per deciliter). Lola always has a saltshaker at her table and likes salty food.

1. What are the risk factors that put Lola at risk for heart disease?
  - a. Using small amounts of salt, being physically inactive, and being overweight.
  - b. Having high blood pressure, having high blood cholesterol, and having low blood sugar.
  - c. Being female and older than age 55, having high blood pressure, having high blood cholesterol, having a BMI of 25 or more, and eating foods high in sodium.
  - d. Having high blood cholesterol, having low blood pressure, using lots of salt, and not being physically active.
2. A community health worker explains to Lola what high blood pressure is:
  - a. High blood pressure is the number you get when you add 100 to your age.
  - b. High blood pressure is when the body circulates more blood based on your height and weight.
  - c. High blood pressure is a measurement of 140/90 mmHg or greater.
  - d. High blood pressure is when the blood suddenly stops going to the brain.

Rose, Lola’s daughter-in-law, cooks with a lot of fat. She is 15 pounds overweight and has learned that she has prediabetes. She prepares *Morisqueta Tostada* (Filipino fried rice), fried *lumpia*, and likes *pastillas de leche* (a milk-candy dessert made with condensed milk). When Rose does not have time to cook, she buys a supersized cheeseburger, french fries, and a regular soda. Instead of walking, Rose drives her car, even to the corner. Her “best friends” are the remote control for her television and her green chair. Rose’s cholesterol level is 240 mg/dL.

3. Rose’s risk factors and lifestyle behaviors that put her at risk for developing heart disease are:
  - a. Having high blood cholesterol, walking, and being age 45 and overweight.
  - b. Being overweight, having high blood pressure, and having a family history of heart disease.
  - c. Being overweight, not being physically active, and cooking and buying foods high in fat.
  - d. Being age 45, having had a heart attack before, and having low blood pressure.

# Community Health Worker Train the Trainer

## Pretest and Posttest *(continued)*

---

4. Which of these lifestyle changes can help people prevent heart disease? Mark your answer with an **X**.

a.	Reading the Nutrition Facts label to choose foods with a sodium level of less than 5 percent of the Percent Daily Value for sodium.	<input type="checkbox"/> <sub>1</sub> Yes	<input type="checkbox"/> <sub>2</sub> No	<input type="checkbox"/> <sub>3</sub> Don't know
b.	Preparing foods by baking, broiling, or grilling, instead of frying.	<input type="checkbox"/> <sub>1</sub> Yes	<input type="checkbox"/> <sub>2</sub> No	<input type="checkbox"/> <sub>3</sub> Don't know
c.	Drinking a lot of whole milk.	<input type="checkbox"/> <sub>1</sub> Yes	<input type="checkbox"/> <sub>2</sub> No	<input type="checkbox"/> <sub>3</sub> Don't know
d.	Stocking the kitchen with lots of snacks like potato chips.	<input type="checkbox"/> <sub>1</sub> Yes	<input type="checkbox"/> <sub>2</sub> No	<input type="checkbox"/> <sub>3</sub> Don't know
e.	Cooking food with lard and high-sodium sauces, such as <i>patis</i> (fish sauce).	<input type="checkbox"/> <sub>1</sub> Yes	<input type="checkbox"/> <sub>2</sub> No	<input type="checkbox"/> <sub>3</sub> Don't know
f.	Eating large portions of food.	<input type="checkbox"/> <sub>1</sub> Yes	<input type="checkbox"/> <sub>2</sub> No	<input type="checkbox"/> <sub>3</sub> Don't know

5. This question is about food serving sizes. Mark your answer with an **X**.

a.	Is 1 cup of white, steamed rice one serving?	<input type="checkbox"/> <sub>1</sub> Yes	<input type="checkbox"/> <sub>2</sub> No	<input type="checkbox"/> <sub>3</sub> Don't know
b.	Is ½ cup of corn and peas one serving?	<input type="checkbox"/> <sub>1</sub> Yes	<input type="checkbox"/> <sub>2</sub> No	<input type="checkbox"/> <sub>3</sub> Don't know
c.	Is ½ cup of pineapple juice one serving?	<input type="checkbox"/> <sub>1</sub> Yes	<input type="checkbox"/> <sub>2</sub> No	<input type="checkbox"/> <sub>3</sub> Don't know
d.	Is ½ cup of cooked beans one serving?	<input type="checkbox"/> <sub>1</sub> Yes	<input type="checkbox"/> <sub>2</sub> No	<input type="checkbox"/> <sub>3</sub> Don't know
e.	Is ½ cup of cooked bok choy one serving?	<input type="checkbox"/> <sub>1</sub> Yes	<input type="checkbox"/> <sub>2</sub> No	<input type="checkbox"/> <sub>3</sub> Don't know

6. Do you think that the following actions help you take steps toward a healthier lifestyle? Mark your answer with an **X**.

a.	Removing the skin from chicken.	<input type="checkbox"/> <sub>1</sub> Agree	<input type="checkbox"/> <sub>2</sub> Disagree	<input type="checkbox"/> <sub>3</sub> Don't know
b.	Cooking with lard instead of canola, safflower, or sesame oil.	<input type="checkbox"/> <sub>1</sub> Agree	<input type="checkbox"/> <sub>2</sub> Disagree	<input type="checkbox"/> <sub>3</sub> Don't know
c.	Buying canned vegetables instead of frozen vegetables.	<input type="checkbox"/> <sub>1</sub> Agree	<input type="checkbox"/> <sub>2</sub> Disagree	<input type="checkbox"/> <sub>3</sub> Don't know
d.	Choosing regular sandwiches instead of deluxe sandwiches when eating out.	<input type="checkbox"/> <sub>1</sub> Agree	<input type="checkbox"/> <sub>2</sub> Disagree	<input type="checkbox"/> <sub>3</sub> Don't know
e.	Adding fruits and vegetables to your meals.	<input type="checkbox"/> <sub>1</sub> Agree	<input type="checkbox"/> <sub>2</sub> Disagree	<input type="checkbox"/> <sub>3</sub> Don't know

# Community Health Worker Train the Trainer

## Pretest and Posttest *(continued)*

---

7. Mark your answer with an **X** for the following statements.

a.	Secondhand smoke is not dangerous to your heart health.	<input type="checkbox"/> <sub>1</sub> Agree	<input type="checkbox"/> <sub>2</sub> Disagree	<input type="checkbox"/> <sub>3</sub> Don't know
b.	The desirable level for LDL, "bad" cholesterol, is less than 100 mg/dL.	<input type="checkbox"/> <sub>1</sub> Agree	<input type="checkbox"/> <sub>2</sub> Disagree	<input type="checkbox"/> <sub>3</sub> Don't know
c.	Having a waist measure greater than 35 inches (88 cm) is healthy for a woman.	<input type="checkbox"/> <sub>1</sub> Agree	<input type="checkbox"/> <sub>2</sub> Disagree	<input type="checkbox"/> <sub>3</sub> Don't know
d.	Adults need about 60 minutes of moderate to vigorous physical activity on most days to prevent weight gain.	<input type="checkbox"/> <sub>1</sub> Agree	<input type="checkbox"/> <sub>2</sub> Disagree	<input type="checkbox"/> <sub>3</sub> Don't know
e.	The hemoglobin A1C test shows the average blood glucose level during the last 24 hours.	<input type="checkbox"/> <sub>1</sub> Agree	<input type="checkbox"/> <sub>2</sub> Disagree	<input type="checkbox"/> <sub>3</sub> Don't know
f.	People know when they have high blood cholesterol because they begin to gain weight.	<input type="checkbox"/> <sub>1</sub> Agree	<input type="checkbox"/> <sub>2</sub> Disagree	<input type="checkbox"/> <sub>3</sub> Don't know

8. A heart healthy diet should be followed by:  
(Circle the answer below that you think correctly completes this statement.)

- a. Only people who have high blood cholesterol.
- b. Only adults who have heart disease.
- c. Everyone older than 2 years of age for their lifetimes.
- d. Everyone between 40 and 65 years old.

9. How important is it to you to reduce your risk of heart disease? (Mark your answer with an **X**.)

- <sub>1</sub> Not important    <sub>2</sub> Somewhat important    <sub>3</sub> Important    <sub>4</sub> Very important

10. How confident are you about teaching the "Healthy Heart, Healthy Family" manual to community members? (Mark your answer with an **X**.)

- <sub>1</sub> I am not confident.
- <sub>2</sub> I am somewhat confident.
- <sub>3</sub> I am confident.
- <sub>4</sub> I am very confident.

# Feedback Form—What Did You Think About the Training? (for Strategy 1)

Participant identification (ID) number (*optional*): \_\_\_\_\_

Date (DD/MM/YYYY): \_\_\_\_\_ / \_\_\_\_\_ / \_\_\_\_\_

City: \_\_\_\_\_ State: \_\_\_\_\_

Circle only one answer for each question.

	Poor	Fair	Good	Very Good	Excellent
1. The training you attended was	1	2	3	4	5
2. The handouts in the manual were	1	2	3	4	5
3. The picture cards were	1	2	3	4	5
4. The demonstrations were	1	2	3	4	5
5. The audiovisuals were	1	2	3	4	5
6. The content presented was	1	2	3	4	5
7. The educational materials were	1	2	3	4	5
8. The trainer's knowledge of the manual content was	1	2	3	4	5
9. The way the trainer taught the manual was	1	2	3	4	5
10. The activities you participated in (e.g., role plays, pledges, etc.) were	1	2	3	4	5

Write your answers to the following questions.

11. What did you like best about the training?

---

---

---

12. What did you like least about the training?

---

---

---

13. Are there any areas that should be improved for future trainings?

---

---

---

# Feedback Form—What Did You Think About the Training? (for Strategy 1) *(continued)*

Circle only one answer for each question.

	<b>I will not</b>	<b>Most likely I will not</b>	<b>Don't know</b>	<b>Most likely I will</b>	<b>I will</b>
14. Will you teach the “Healthy Heart, Healthy Family” manual to community members?	1	2	3	4	5
15. Will you change your health habits?	1	2	3	4	5
16. Will you share the information from the training with your family?	1	2	3	4	5
17. Will you share the information from the training with friends?	1	2	3	4	5
18. Will you share the information from the training with community health workers?	1	2	3	4	5

19. Are there other ways that you can share the information? <sub>1</sub> Yes <sub>2</sub> No

19a. If yes, please explain: \_\_\_\_\_

20. What changes will you make as a result of participating in the training?

\_\_\_\_\_

\_\_\_\_\_

\_\_\_\_\_

21. Other comments:

\_\_\_\_\_

\_\_\_\_\_

\_\_\_\_\_

# My Health Habits Pretest and Posttest

<b>FOR INTERNAL USE ONLY</b> <b>(For Strategies 2a, 2b, and 3)</b>	
<input type="checkbox"/> <sub>1</sub> Pretest	Start Date (MM/DD/YYYY): ____/____/____
<input type="checkbox"/> <sub>2</sub> Posttest	End Date (MM/DD/YYYY): ____/____/____
Name of person administering the “My Health Habits” questionnaire: _____	
<b>Project Location:</b>	
<input type="checkbox"/> <sub>1</sub> Clinic	
Patient identification (ID) number: _____	
<input type="checkbox"/> <sub>2</sub> Community-based organization	
Participant identification (ID) number: _____	
<input type="checkbox"/> <sub>3</sub> Other: _____	
Participant identification (ID) number: _____	

## Participant Information

1. Today’s date (MM/DD/YYYY): ____/____/____
2. Age (in years): _____
3. Gender: <input type="checkbox"/> <sub>1</sub> Male <input type="checkbox"/> <sub>2</sub> Female
4. (a) Place of birth: _____
<div style="display: flex; justify-content: space-between; width: 100%;"> <span>City</span> <span>State</span> <span>Country</span> </div>
(b) If your place of birth is in the Philippines, the city is located in the: <input type="checkbox"/> <sub>1</sub> Northern Philippines <input type="checkbox"/> <sub>2</sub> Central Philippines <input type="checkbox"/> <sub>3</sub> Southern Philippines <input type="checkbox"/> <sub>4</sub> N/A
5. Do you consider yourself Latino or Hispanic? <input type="checkbox"/> <sub>1</sub> Yes <input type="checkbox"/> <sub>2</sub> No
6. What race do you consider yourself to be? <input type="checkbox"/> <sub>1</sub> Alaska Native <input type="checkbox"/> <sub>2</sub> American Indian <input type="checkbox"/> <sub>3</sub> Asian <input type="checkbox"/> <sub>4</sub> Black/African American <input type="checkbox"/> <sub>5</sub> Native Hawaiian or other Pacific Islander <input type="checkbox"/> <sub>6</sub> White
7. Time living in the United States: ____ Years ____ Months

# My Health Habits

## Pretest and Posttest *(continued)*

8. (a) Language you prefer: <input type="checkbox"/> <sub>1</sub> English <input type="checkbox"/> <sub>2</sub> Tagalog <input type="checkbox"/> <sub>3</sub> Both <input type="checkbox"/> <sub>4</sub> Other (b) If language is “Other,” please name the language you prefer: _____
9. Have you been told by a health care professional that you have diabetes? <input type="checkbox"/> <sub>1</sub> Yes <input type="checkbox"/> <sub>2</sub> No <input type="checkbox"/> <sub>3</sub> Don’t know
10. Does your family have a history of heart disease? <input type="checkbox"/> <sub>1</sub> Yes <input type="checkbox"/> <sub>2</sub> No <input type="checkbox"/> <sub>3</sub> Don’t know

### Salt and Sodium

How often do you do the following things? Mark your answer with an **X**.

1. Do you buy fresh vegetables instead of canned vegetables?	<input type="checkbox"/> <sub>1</sub> Never	<input type="checkbox"/> <sub>2</sub> Sometimes	<input type="checkbox"/> <sub>3</sub> Most of the time	<input type="checkbox"/> <sub>4</sub> All the time
2. Do you use <i>patis</i> (fish sauce), <i>Bagoang alamang</i> (salted shrimp paste) or soy sauce when you cook?	<input type="checkbox"/> <sub>1</sub> Never	<input type="checkbox"/> <sub>2</sub> Sometimes	<input type="checkbox"/> <sub>3</sub> Most of the time	<input type="checkbox"/> <sub>4</sub> All the time
3. Do you read Nutrition Facts labels to choose foods with a low-sodium content?	<input type="checkbox"/> <sub>1</sub> Never	<input type="checkbox"/> <sub>2</sub> Sometimes	<input type="checkbox"/> <sub>3</sub> Most of the time	<input type="checkbox"/> <sub>4</sub> All the time
4. Do you add salt to fruit?	<input type="checkbox"/> <sub>1</sub> Never	<input type="checkbox"/> <sub>2</sub> Sometimes	<input type="checkbox"/> <sub>3</sub> Most of the time	<input type="checkbox"/> <sub>4</sub> All the time
5. Do you add salt to the water when you steam rice or cook noodles, beans or vegetables?	<input type="checkbox"/> <sub>1</sub> Never	<input type="checkbox"/> <sub>2</sub> Sometimes	<input type="checkbox"/> <sub>3</sub> Most of the time	<input type="checkbox"/> <sub>4</sub> All the time
6. Do you buy meats such as canned pork, hotdogs, corned beef hash, or sausage?	<input type="checkbox"/> <sub>1</sub> Never	<input type="checkbox"/> <sub>2</sub> Sometimes	<input type="checkbox"/> <sub>3</sub> Most of the time	<input type="checkbox"/> <sub>4</sub> All the time
7. Do you use a saltshaker at the table?	<input type="checkbox"/> <sub>1</sub> Never	<input type="checkbox"/> <sub>2</sub> Sometimes	<input type="checkbox"/> <sub>3</sub> Most of the time	<input type="checkbox"/> <sub>4</sub> All the time
8. Do you fill the saltshaker with a mixture of herbs and spices instead of salt?	<input type="checkbox"/> <sub>1</sub> Never	<input type="checkbox"/> <sub>2</sub> Sometimes	<input type="checkbox"/> <sub>3</sub> Most of the time	<input type="checkbox"/> <sub>4</sub> All the time
9. Do you choose fruits and vegetables instead of beef jerky, chips, french fries, and pork rinds?	<input type="checkbox"/> <sub>1</sub> Never	<input type="checkbox"/> <sub>2</sub> Sometimes	<input type="checkbox"/> <sub>3</sub> Most of the time	<input type="checkbox"/> <sub>4</sub> All the time

# My Health Habits

## Pretest and Posttest *(continued)*

### Cholesterol and Fat

How often do you do the following things? Mark your answer with an **X**.

1. Do you drink fat-free milk or 1% milk?	<input type="checkbox"/> <sub>1</sub> Never	<input type="checkbox"/> <sub>2</sub> Sometimes	<input type="checkbox"/> <sub>3</sub> Most of the time	<input type="checkbox"/> <sub>4</sub> All the time
2. Do you eat low-fat cheese?	<input type="checkbox"/> <sub>1</sub> Never	<input type="checkbox"/> <sub>2</sub> Sometimes	<input type="checkbox"/> <sub>3</sub> Most of the time	<input type="checkbox"/> <sub>4</sub> All the time
3. Do you use vegetable oil spray to grease baking pans and skillets instead of lard, coconut oil, or butter?	<input type="checkbox"/> <sub>1</sub> Never	<input type="checkbox"/> <sub>2</sub> Sometimes	<input type="checkbox"/> <sub>3</sub> Most of the time	<input type="checkbox"/> <sub>4</sub> All the time
4. Do you read the Nutrition Facts label to help you choose foods lower in saturated fat, <i>trans</i> fat, and cholesterol?	<input type="checkbox"/> <sub>1</sub> Never	<input type="checkbox"/> <sub>2</sub> Sometimes	<input type="checkbox"/> <sub>3</sub> Most of the time	<input type="checkbox"/> <sub>4</sub> All the time
5. Do you remove the skin before cooking chicken?	<input type="checkbox"/> <sub>1</sub> Never	<input type="checkbox"/> <sub>2</sub> Sometimes	<input type="checkbox"/> <sub>3</sub> Most of the time	<input type="checkbox"/> <sub>4</sub> All the time
6. Do you drain the fat and throw it away when you cook ground meat?	<input type="checkbox"/> <sub>1</sub> Never	<input type="checkbox"/> <sub>2</sub> Sometimes	<input type="checkbox"/> <sub>3</sub> Most of the time	<input type="checkbox"/> <sub>4</sub> All the time
7. Do you choose fat-free or low-fat mayonnaise or sour cream?	<input type="checkbox"/> <sub>1</sub> Never	<input type="checkbox"/> <sub>2</sub> Sometimes	<input type="checkbox"/> <sub>3</sub> Most of the time	<input type="checkbox"/> <sub>4</sub> All the time
8. Do you use canola, safflower, or sesame oil to prepare your food instead of using lard?	<input type="checkbox"/> <sub>1</sub> Never	<input type="checkbox"/> <sub>2</sub> Sometimes	<input type="checkbox"/> <sub>3</sub> Most of the time	<input type="checkbox"/> <sub>4</sub> All the time

### Weight Management

How often do you do the following things? Mark your answer with an **X**.

1. Do you read Nutrition Facts labels to choose foods lower in calories?	<input type="checkbox"/> <sub>1</sub> Never	<input type="checkbox"/> <sub>2</sub> Sometimes	<input type="checkbox"/> <sub>3</sub> Most of the time	<input type="checkbox"/> <sub>4</sub> All the time
2. Do you bake or grill chicken or other foods instead of frying them?	<input type="checkbox"/> <sub>1</sub> Never	<input type="checkbox"/> <sub>2</sub> Sometimes	<input type="checkbox"/> <sub>3</sub> Most of the time	<input type="checkbox"/> <sub>4</sub> All the time
3. Do you serve more vegetables on your plate than you do meat?	<input type="checkbox"/> <sub>1</sub> Never	<input type="checkbox"/> <sub>2</sub> Sometimes	<input type="checkbox"/> <sub>3</sub> Most of the time	<input type="checkbox"/> <sub>4</sub> All the time



# My Health Habits

## Pretest and Posttest *(continued)*

4. Do you serve yourself large portions of food?	<input type="checkbox"/> <sub>1</sub> Never	<input type="checkbox"/> <sub>2</sub> Sometimes	<input type="checkbox"/> <sub>3</sub> Most of the time	<input type="checkbox"/> <sub>4</sub> All the time
5. Do you drink water instead of regular soda?	<input type="checkbox"/> <sub>1</sub> Never	<input type="checkbox"/> <sub>2</sub> Sometimes	<input type="checkbox"/> <sub>3</sub> Most of the time	<input type="checkbox"/> <sub>4</sub> All the time
6. Do you have drinks with sugar, such as mango nectar, or other drinks?	<input type="checkbox"/> <sub>1</sub> Never	<input type="checkbox"/> <sub>2</sub> Sometimes	<input type="checkbox"/> <sub>3</sub> Most of the time	<input type="checkbox"/> <sub>4</sub> All the time
7. Do you eat fruits instead of desserts or snacks that contain high amounts of sugar?	<input type="checkbox"/> <sub>1</sub> Never	<input type="checkbox"/> <sub>2</sub> Sometimes	<input type="checkbox"/> <sub>3</sub> Most of the time	<input type="checkbox"/> <sub>4</sub> All the time
8. Do you eat more when you feel stressed?	<input type="checkbox"/> <sub>1</sub> Never	<input type="checkbox"/> <sub>2</sub> Sometimes	<input type="checkbox"/> <sub>3</sub> Most of the time	<input type="checkbox"/> <sub>4</sub> All the time

### Physical Activity

Mark your answer with an **X**.

1. Do you do any type of physical activity at your job? <input type="checkbox"/> <sub>1</sub> Yes <input type="checkbox"/> <sub>2</sub> No
2. Not including what you do at your job, do you do any other physical activity? <input type="checkbox"/> <sub>1</sub> Yes <input type="checkbox"/> <sub>2</sub> No <b>(GO TO SMOKING)</b> If yes, answer the following questions.
2a. What type of physical activity do you do? <input type="checkbox"/> <sub>1</sub> Walking <input type="checkbox"/> <sub>2</sub> Aerobic exercise <input type="checkbox"/> <sub>3</sub> Playing sports <input type="checkbox"/> <sub>4</sub> Other(s) (please specify): _____
2b. How often do you do physical activity? <input type="checkbox"/> <sub>1</sub> Rarely (1 day a week) <input type="checkbox"/> <sub>2</sub> Several times a week (2 to 6 days a week) <input type="checkbox"/> <sub>3</sub> Every day

# My Health Habits

## Pretest and Posttest *(continued)*

2c. How many minutes per day do you do physical activity?

- <sub>1</sub> Less than 30 minutes  
<sub>2</sub> 30 to 59 minutes  
<sub>3</sub> 60 minutes or more

### Smoking

Mark your answer with an **X**.

1. Do you smoke?	<input type="checkbox"/> <sub>1</sub> Yes	<input type="checkbox"/> <sub>2</sub> No
2. Does anyone else in your family smoke?	<input type="checkbox"/> <sub>1</sub> Yes	<input type="checkbox"/> <sub>2</sub> No
3. Do you allow people to smoke in your home?	<input type="checkbox"/> <sub>1</sub> Yes	<input type="checkbox"/> <sub>2</sub> No

### Alcohol

Mark your answer with an **X**.

**Note:** One drink is 12 ounces of beer **OR** 5 ounces of wine **OR** 1½ ounces of spirits (liquor or whiskey, straight or in a mixed drink). Drinking may occur every day, some days, or just on the weekend.

1. Do you drink alcohol?  
<sub>1</sub> Yes    <sub>2</sub> No (**GO TO KNOWLEDGE**)  
 If yes, answer the following questions.

- 1a. How often do you drink?  
<sub>1</sub> Rarely (on special occasions)  
<sub>2</sub> Occasionally (once a month)  
<sub>3</sub> Once a week  
<sub>4</sub> Regularly (several times a week)  
<sub>5</sub> Every day

- 1b. When you drink, how many drinks do you have per occasion?  
<sub>1</sub> One to two drinks  
<sub>2</sub> Three to four drinks  
<sub>3</sub> Five or more drinks

# My Health Habits

## Pretest and Posttest *(continued)*

1c. How often do you drink more than three drinks in one day?

- <sub>1</sub> Never
- <sub>2</sub> Once or twice a week
- <sub>3</sub> Three to six times per week
- <sub>4</sub> Every day

### Knowledge

Mark your answer with an **X**.

1. Can a high waist measure increase your risk of heart disease?	<input type="checkbox"/> <sub>1</sub> Yes	<input type="checkbox"/> <sub>2</sub> No	<input type="checkbox"/> <sub>3</sub> Don't know
2. Can the body mass index (BMI) tell you if you are overweight?	<input type="checkbox"/> <sub>1</sub> Yes	<input type="checkbox"/> <sub>2</sub> No	<input type="checkbox"/> <sub>3</sub> Don't know
3. Does your liver make all the cholesterol your body needs to keep you healthy?	<input type="checkbox"/> <sub>1</sub> Yes	<input type="checkbox"/> <sub>2</sub> No	<input type="checkbox"/> <sub>3</sub> Don't know
4. Can eating foods that are high in sodium increase your risk of high blood pressure?	<input type="checkbox"/> <sub>1</sub> Yes	<input type="checkbox"/> <sub>2</sub> No	<input type="checkbox"/> <sub>3</sub> Don't know
5. Does lard have a low amount of saturated fat?	<input type="checkbox"/> <sub>1</sub> Yes	<input type="checkbox"/> <sub>2</sub> No	<input type="checkbox"/> <sub>3</sub> Don't know
6. Can eating too much saturated fat and <i>trans</i> fat raise your cholesterol level?	<input type="checkbox"/> <sub>1</sub> Yes	<input type="checkbox"/> <sub>2</sub> No	<input type="checkbox"/> <sub>3</sub> Don't know
7. Is a blood pressure of 140/90 mmHg considered high?	<input type="checkbox"/> <sub>1</sub> Yes	<input type="checkbox"/> <sub>2</sub> No	<input type="checkbox"/> <sub>3</sub> Don't know
8. Can being overweight or obese put you at risk for developing high blood cholesterol?	<input type="checkbox"/> <sub>1</sub> Yes	<input type="checkbox"/> <sub>2</sub> No	<input type="checkbox"/> <sub>3</sub> Don't know
9. Is being physically active a way to reduce your risk for heart disease?	<input type="checkbox"/> <sub>1</sub> Yes	<input type="checkbox"/> <sub>2</sub> No	<input type="checkbox"/> <sub>3</sub> Don't know
10. Only people with high blood cholesterol should follow a heart healthy diet.	<input type="checkbox"/> <sub>1</sub> Yes	<input type="checkbox"/> <sub>2</sub> No	<input type="checkbox"/> <sub>3</sub> Don't know
11. Can nonsmokers die from secondhand smoke?	<input type="checkbox"/> <sub>1</sub> Yes	<input type="checkbox"/> <sub>2</sub> No	<input type="checkbox"/> <sub>3</sub> Don't know
12. Is having a fasting blood sugar of 126 mg/dL or higher considered diabetes?	<input type="checkbox"/> <sub>1</sub> Yes	<input type="checkbox"/> <sub>2</sub> No	<input type="checkbox"/> <sub>3</sub> Don't know

# My Health Habits

## Pretest and Posttest *(continued)*

---

### A Day with the de la Cruz Family

People act in different ways when they learn that they need to make changes to lower their chances of getting heart disease.

Read about how the members of the de la Cruz family react to the news about their risks for heart disease. Then place an **X** next to the name of the family member with whom you identify the most.



**Ric: “I don’t really care.”**

Ric learns that he is at risk for heart disease but he is not concerned. He gets upset when he’s reminded about changing his unhealthy habits. He has no intention of making changes for better heart health. “Whatever will be, will be,” claims Ric.



**Mila: “I am stuck.”**

Mila is worried because she knows that smoking is a risk factor for heart disease and she is aware of the effect that secondhand smoking has on asthma. She thinks about making changes, but cannot get started. She feels trapped and is not motivated to take steps for better health. “You can bring a horse to water but you cannot make it drink,” ponders Mila.



**Rose: “I am making plans.”**

Rose learns that her husband is at risk for heart disease and thinks that she should make changes. Instead of putting off her efforts until tomorrow, she asks her friends and family for suggestions on how she can make heart healthy changes for her family. “Walking the walk is harder than talking the talk,” says Rose.



**Lola (Mrs. Caridad de la Cruz): “I am taking action.”**

Lola learns that she is at risk for heart disease and quickly starts doing something about it. She goes to classes to learn how to improve her health. She practices what she learns. Lola makes simple changes and helps others to do the same. “An ounce of prevention is better than a pound of cure,” says Lola.



**Jose: “I stay on the healthy path.”**

Jose is making changes and is motivated to stay on track to improve his health. He knows that it is easy to fall back into old habits. He makes plans to prevent setbacks and learns to start again if he needs to. He is positive toward life. He asks for help and does not give up. “Time is gold, and health is priceless,” says Jose.

# My Health Habits

## Posttest Questions Only

---

Please answer these questions after completing all of the sessions of the “Healthy Heart, Healthy Family” manual. Mark your answer with an **X**.

1. How satisfied are you with the Healthy Heart, Healthy Family project presented by community health workers?

<sub>1</sub>I am not satisfied.

<sub>2</sub>I am somewhat satisfied.

<sub>3</sub>I am satisfied.

<sub>4</sub>I am very satisfied.

2. With whom have you shared the information from the sessions? (Mark your answer with an **X**. You may select more than one answer.)

<sub>1</sub>Friends

<sub>2</sub>Family

<sub>3</sub>Coworkers

<sub>4</sub>Other (please specify): \_\_\_\_\_

# Screening Form

<b>FOR INTERNAL USE ONLY</b> <b>(For Strategy 2b)</b>
Participant identification (ID) number: _____
Name of person completing the form: _____
Community health worker's identification (ID) number: _____
<b>Project Location:</b> <input type="checkbox"/> <sub>2</sub> Community-based organization: _____ <input type="checkbox"/> <sub>3</sub> Other setting (please specify): _____
Name of partnering organization: _____

Use this chart to record the screening information from each project participant.		
	Pretest Date (MM/DD/YYYY): ____/____/____	Posttest Date (MM/DD/YYYY): ____/____/____
<b>Blood Pressure</b> Average of two readings: Systolic (top number) Diastolic (bottom number)	____ mmHg ____ mmHg	____ mmHg ____ mmHg
<b>Overweight and Obesity</b> Height Weight Body Mass Index (BMI) Waist measure	____ feet ____ inches ____ cm ____ pounds / ____ kilograms ____ ____ inches or ____ centimeters	____ feet ____ inches ____ cm ____ pounds / ____ kilograms ____ ____ inches or ____ centimeters
<b>Blood Cholesterol</b> Total LDL HDL Triglycerides	____ mg/dL ____ mg/dL ____ mg/dL ____ mg/dL	____ mg/dL ____ mg/dL ____ mg/dL ____ mg/dL
<b>Blood Glucose</b> Hb A1C Blood glucose level (nonfasting) Blood glucose level (fasting)	____ % ____ mg/dL ____ mg/dL	____ % ____ mg/dL ____ mg/dL
<b>All participants with elevated levels are to be referred for further evaluation.</b>		
Does participant have elevated level(s)? <input type="checkbox"/> <sub>1</sub> Yes <input type="checkbox"/> <sub>2</sub> No If yes, participant was referred to: _____		
Did the participant go for followup care? <input type="checkbox"/> <sub>1</sub> Yes <input type="checkbox"/> <sub>2</sub> No		

# Clinical Measures and Followup Form

**FOR INTERNAL USE ONLY**  
**(For Strategy 3)**

Participant identification (ID) number: \_\_\_\_\_

Name of person completing the form: \_\_\_\_\_

Community health worker's identification (ID) number: \_\_\_\_\_

**Project Location:**

<sub>1</sub> Clinic

**Participant Information**

1. Today's date (MM/DD/YYYY): \_\_\_\_/\_\_\_\_/\_\_\_\_

2. Age \_\_\_\_

3. Gender: <sub>1</sub> Male <sub>2</sub> Female

4. Do you consider yourself Latino or Hispanic? <sub>1</sub> Yes <sub>2</sub> No

5. What race do you consider yourself to be?  
<sub>1</sub> Alaska Native  
<sub>2</sub> American Indian  
<sub>3</sub> Asian  
<sub>4</sub> Black or African American  
<sub>5</sub> Native Hawaiian or other Pacific Islander  
<sub>6</sub> White

6. (a) Place of birth: \_\_\_\_\_  
City State Country

(b) If your place of birth is in the Philippines, the city is located in the:  
<sub>1</sub> Northern Philippines <sub>2</sub> Central Philippines <sub>3</sub> Southern Philippines <sub>4</sub> N/A

7. Time living in the United States: \_\_\_\_ Years \_\_\_\_ Months

8. (a) Language you prefer: <sub>1</sub> English <sub>2</sub> Tagalog <sub>3</sub> Both <sub>3</sub> Other

(b) If language is "Other," please name the language you prefer: \_\_\_\_\_

9. Does your family have a history of heart disease? <sub>1</sub> Yes <sub>2</sub> No <sub>3</sub> Don't know

## Clinical Measures and Followup Form *(continued)*

	<b>Baseline</b> Date: __/__/__	<b>6 Months After Baseline</b> Date: __/__/__	<b>12 Months After Baseline</b> Date: __/__/__
<b>10. Blood cholesterol</b>			
Have you ever been told by a doctor or other health professional that you have high blood cholesterol?	<input type="checkbox"/> <sub>1</sub> Yes <input type="checkbox"/> <sub>2</sub> No	<input type="checkbox"/> <sub>1</sub> Yes <input type="checkbox"/> <sub>2</sub> No	<input type="checkbox"/> <sub>1</sub> Yes <input type="checkbox"/> <sub>2</sub> No
Are you on medication(s)?	<input type="checkbox"/> <sub>1</sub> Yes <input type="checkbox"/> <sub>2</sub> No	<input type="checkbox"/> <sub>1</sub> Yes <input type="checkbox"/> <sub>2</sub> No	<input type="checkbox"/> <sub>1</sub> Yes <input type="checkbox"/> <sub>2</sub> No
Total blood cholesterol	_____ mg/dL	_____ mg/dL	_____ mg/dL
LDL	_____ mg/dL	_____ mg/dL	_____ mg/dL
HDL	_____ mg/dL	_____ mg/dL	_____ mg/dL
Triglycerides	_____ mg/dL	_____ mg/dL	_____ mg/dL
<b>11. Blood pressure</b>			
Have you ever been told by a doctor or other health professional that you have prehypertension?	<input type="checkbox"/> <sub>1</sub> Yes <input type="checkbox"/> <sub>2</sub> No	<input type="checkbox"/> <sub>1</sub> Yes <input type="checkbox"/> <sub>2</sub> No	<input type="checkbox"/> <sub>1</sub> Yes <input type="checkbox"/> <sub>2</sub> No
Have you ever been told by a doctor or other health professional that you have high blood pressure?	<input type="checkbox"/> <sub>1</sub> Yes <input type="checkbox"/> <sub>2</sub> No	<input type="checkbox"/> <sub>1</sub> Yes <input type="checkbox"/> <sub>2</sub> No	<input type="checkbox"/> <sub>1</sub> Yes <input type="checkbox"/> <sub>2</sub> No
Are you on medication(s)?	<input type="checkbox"/> <sub>1</sub> Yes <input type="checkbox"/> <sub>2</sub> No	<input type="checkbox"/> <sub>1</sub> Yes <input type="checkbox"/> <sub>2</sub> No	<input type="checkbox"/> <sub>1</sub> Yes <input type="checkbox"/> <sub>2</sub> No
Average of two readings			
Systolic (top number)	_____ mmHg	_____ mmHg	_____ mmHg
Diastolic (bottom number)	_____ mmHg	_____ mmHg	_____ mmHg



## Clinical Measures and Followup Form *(continued)*

	<b>Baseline</b> Date: __/__/__	<b>6 Months After Baseline</b> Date: __/__/__	<b>12 Months After Baseline</b> Date: __/__/__
<b>12. Diabetes</b>			
Have you ever been told by a doctor or other health professional that you have prediabetes?	<input type="checkbox"/> <sub>1</sub> Yes <input type="checkbox"/> <sub>2</sub> No	<input type="checkbox"/> <sub>1</sub> Yes <input type="checkbox"/> <sub>2</sub> No	<input type="checkbox"/> <sub>1</sub> Yes <input type="checkbox"/> <sub>2</sub> No
Have you ever been told by a doctor or other health professional that you have high blood glucose?	<input type="checkbox"/> <sub>1</sub> Yes <input type="checkbox"/> <sub>2</sub> No	<input type="checkbox"/> <sub>1</sub> Yes <input type="checkbox"/> <sub>2</sub> No	<input type="checkbox"/> <sub>1</sub> Yes <input type="checkbox"/> <sub>2</sub> No
Are you on medication(s)?	<input type="checkbox"/> <sub>1</sub> Yes <input type="checkbox"/> <sub>2</sub> No	<input type="checkbox"/> <sub>1</sub> Yes <input type="checkbox"/> <sub>2</sub> No	<input type="checkbox"/> <sub>1</sub> Yes <input type="checkbox"/> <sub>2</sub> No
Hb A1C	_____ %	_____ %	_____ %
Blood glucose level (fasting)	_____ mg/dL	_____ mg/dL	_____ mg/dL
<b>13. Overweight and obesity</b>			
Weight	_____ pounds or _____ kilograms	_____ pounds or _____ kilograms	_____ pounds or _____ kilograms
Height	___ feet ___ inches or ___ centimeters	___ feet ___ inches or ___ centimeters	___ feet ___ inches or ___ centimeters
Body mass index (BMI)	_____ BMI	_____ BMI	_____ BMI
Waist measure	___ inches or ___ centimeters	___ inches or ___ centimeters	___ inches or ___ centimeters
<b>14. Medication (If the patient is on medication[s], ask the question below.)</b>			
Do you take your medication(s) as prescribed by the doctor?	<input type="checkbox"/> <sub>1</sub> Yes <input type="checkbox"/> <sub>2</sub> No	<input type="checkbox"/> <sub>1</sub> Yes <input type="checkbox"/> <sub>2</sub> No	<input type="checkbox"/> <sub>1</sub> Yes <input type="checkbox"/> <sub>2</sub> No

## Clinical Measures and Followup Form *(continued)*

<b>15. If the answer to question 14 is “no,” please ask the patient: “Can you tell me why you are not taking your medication?” (Based on the patient’s response, please check all the answers that apply.)</b>			
	<b>Baseline</b> Date: __/__/__	<b>6 Months After Baseline</b> Date: __/__/__	<b>12 Months After Baseline</b> Date: __/__/__
a. I believe that taking medication every day is not good for me.	<input type="checkbox"/> <sub>1</sub> Yes <input type="checkbox"/> <sub>2</sub> No	<input type="checkbox"/> <sub>1</sub> Yes <input type="checkbox"/> <sub>2</sub> No	<input type="checkbox"/> <sub>1</sub> Yes <input type="checkbox"/> <sub>2</sub> No
b. I forget to take my medication.	<input type="checkbox"/> <sub>1</sub> Yes <input type="checkbox"/> <sub>2</sub> No	<input type="checkbox"/> <sub>1</sub> Yes <input type="checkbox"/> <sub>2</sub> No	<input type="checkbox"/> <sub>1</sub> Yes <input type="checkbox"/> <sub>2</sub> No
c. I did not understand what the doctor told me.	<input type="checkbox"/> <sub>1</sub> Yes <input type="checkbox"/> <sub>2</sub> No	<input type="checkbox"/> <sub>1</sub> Yes <input type="checkbox"/> <sub>2</sub> No	<input type="checkbox"/> <sub>1</sub> Yes <input type="checkbox"/> <sub>2</sub> No
d. I stopped taking the medication when I felt better.	<input type="checkbox"/> <sub>1</sub> Yes <input type="checkbox"/> <sub>2</sub> No	<input type="checkbox"/> <sub>1</sub> Yes <input type="checkbox"/> <sub>2</sub> No	<input type="checkbox"/> <sub>1</sub> Yes <input type="checkbox"/> <sub>2</sub> No
e. I feel sick when I take the medication.	<input type="checkbox"/> <sub>1</sub> Yes <input type="checkbox"/> <sub>2</sub> No	<input type="checkbox"/> <sub>1</sub> Yes <input type="checkbox"/> <sub>2</sub> No	<input type="checkbox"/> <sub>1</sub> Yes <input type="checkbox"/> <sub>2</sub> No
f. I do not have anyone to help me.	<input type="checkbox"/> <sub>1</sub> Yes <input type="checkbox"/> <sub>2</sub> No	<input type="checkbox"/> <sub>1</sub> Yes <input type="checkbox"/> <sub>2</sub> No	<input type="checkbox"/> <sub>1</sub> Yes <input type="checkbox"/> <sub>2</sub> No
g. I do not have money to buy the medication(s).	<input type="checkbox"/> <sub>1</sub> Yes <input type="checkbox"/> <sub>2</sub> No	<input type="checkbox"/> <sub>1</sub> Yes <input type="checkbox"/> <sub>2</sub> No	<input type="checkbox"/> <sub>1</sub> Yes <input type="checkbox"/> <sub>2</sub> No
h. <b>Other reason (please specify):</b>	_____ _____	_____ _____	_____ _____

# Community Health Worker Activities Form

**FOR INTERNAL USE ONLY**

**(For Strategy 3)**

Please complete this form after the manual is taught to record the encounters with the patient.

Participant identification (ID) number: \_\_\_\_\_

Name of person completing the form: \_\_\_\_\_

Community health worker's identification (ID) number: \_\_\_\_\_

Name of person who taught the manual: \_\_\_\_\_

**Project Location:**

Clinic

Which of the following activities do you do? Mark your answer with an **X**.

ACTIVITIES	First Followup Encounter	3-Month Followup	6-Month Followup	12-Month Followup
	Date: __/__/__	Date: __/__/__	Date: __/__/__	Date: __/__/__
1. Listen to the patient's concerns.	<input type="checkbox"/> <sub>1</sub> Yes <input type="checkbox"/> <sub>2</sub> No	<input type="checkbox"/> <sub>1</sub> Yes <input type="checkbox"/> <sub>2</sub> No	<input type="checkbox"/> <sub>1</sub> Yes <input type="checkbox"/> <sub>2</sub> No	<input type="checkbox"/> <sub>1</sub> Yes <input type="checkbox"/> <sub>2</sub> No
2. Make the appointment for the patient.	<input type="checkbox"/> <sub>1</sub> Yes <input type="checkbox"/> <sub>2</sub> No	<input type="checkbox"/> <sub>1</sub> Yes <input type="checkbox"/> <sub>2</sub> No	<input type="checkbox"/> <sub>1</sub> Yes <input type="checkbox"/> <sub>2</sub> No	<input type="checkbox"/> <sub>1</sub> Yes <input type="checkbox"/> <sub>2</sub> No
3. Remind the patient to keep the appointment.	<input type="checkbox"/> <sub>1</sub> Yes <input type="checkbox"/> <sub>2</sub> No	<input type="checkbox"/> <sub>1</sub> Yes <input type="checkbox"/> <sub>2</sub> No	<input type="checkbox"/> <sub>1</sub> Yes <input type="checkbox"/> <sub>2</sub> No	<input type="checkbox"/> <sub>1</sub> Yes <input type="checkbox"/> <sub>2</sub> No
4. Make transportation arrangements for the patient.	<input type="checkbox"/> <sub>1</sub> Yes <input type="checkbox"/> <sub>2</sub> No	<input type="checkbox"/> <sub>1</sub> Yes <input type="checkbox"/> <sub>2</sub> No	<input type="checkbox"/> <sub>1</sub> Yes <input type="checkbox"/> <sub>2</sub> No	<input type="checkbox"/> <sub>1</sub> Yes <input type="checkbox"/> <sub>2</sub> No
5. Serve as interpreter for the patient.	<input type="checkbox"/> <sub>1</sub> Yes <input type="checkbox"/> <sub>2</sub> No	<input type="checkbox"/> <sub>1</sub> Yes <input type="checkbox"/> <sub>2</sub> No	<input type="checkbox"/> <sub>1</sub> Yes <input type="checkbox"/> <sub>2</sub> No	<input type="checkbox"/> <sub>1</sub> Yes <input type="checkbox"/> <sub>2</sub> No
6. Provide counseling/ educational materials to the patient.	<input type="checkbox"/> <sub>1</sub> Yes <input type="checkbox"/> <sub>2</sub> No	<input type="checkbox"/> <sub>1</sub> Yes <input type="checkbox"/> <sub>2</sub> No	<input type="checkbox"/> <sub>1</sub> Yes <input type="checkbox"/> <sub>2</sub> No	<input type="checkbox"/> <sub>1</sub> Yes <input type="checkbox"/> <sub>2</sub> No
7. Go over counseling/ educational materials with the patient.	<input type="checkbox"/> <sub>1</sub> Yes <input type="checkbox"/> <sub>2</sub> No	<input type="checkbox"/> <sub>1</sub> Yes <input type="checkbox"/> <sub>2</sub> No	<input type="checkbox"/> <sub>1</sub> Yes <input type="checkbox"/> <sub>2</sub> No	<input type="checkbox"/> <sub>1</sub> Yes <input type="checkbox"/> <sub>2</sub> No
8. Ask the patient if he or she has any questions about the medication(s).	<input type="checkbox"/> <sub>1</sub> Yes <input type="checkbox"/> <sub>2</sub> No	<input type="checkbox"/> <sub>1</sub> Yes <input type="checkbox"/> <sub>2</sub> No	<input type="checkbox"/> <sub>1</sub> Yes <input type="checkbox"/> <sub>2</sub> No	<input type="checkbox"/> <sub>1</sub> Yes <input type="checkbox"/> <sub>2</sub> No

## Community Health Worker Activities Form *(continued)*

	<b>First Followup Encounter</b>	<b>3-Month Followup</b>	<b>6-Month Followup</b>	<b>12-Month Followup</b>
9. Encourage the patient to stay on the treatment plan.	<input type="checkbox"/> <sub>1</sub> Yes <input type="checkbox"/> <sub>2</sub> No	<input type="checkbox"/> <sub>1</sub> Yes <input type="checkbox"/> <sub>2</sub> No	<input type="checkbox"/> <sub>1</sub> Yes <input type="checkbox"/> <sub>2</sub> No	<input type="checkbox"/> <sub>1</sub> Yes <input type="checkbox"/> <sub>2</sub> No
10. Give suggestions to the patient on how to remember to take the medication(s).	<input type="checkbox"/> <sub>1</sub> Yes <input type="checkbox"/> <sub>2</sub> No	<input type="checkbox"/> <sub>1</sub> Yes <input type="checkbox"/> <sub>2</sub> No	<input type="checkbox"/> <sub>1</sub> Yes <input type="checkbox"/> <sub>2</sub> No	<input type="checkbox"/> <sub>1</sub> Yes <input type="checkbox"/> <sub>2</sub> No
11. Ask the patient about difficulties in changing lifestyle habits.	<input type="checkbox"/> <sub>1</sub> Yes <input type="checkbox"/> <sub>2</sub> No	<input type="checkbox"/> <sub>1</sub> Yes <input type="checkbox"/> <sub>2</sub> No	<input type="checkbox"/> <sub>1</sub> Yes <input type="checkbox"/> <sub>2</sub> No	<input type="checkbox"/> <sub>1</sub> Yes <input type="checkbox"/> <sub>2</sub> No
12. Explain the benefits of changing lifestyle habits to the patient.	<input type="checkbox"/> <sub>1</sub> Yes <input type="checkbox"/> <sub>2</sub> No	<input type="checkbox"/> <sub>1</sub> Yes <input type="checkbox"/> <sub>2</sub> No	<input type="checkbox"/> <sub>1</sub> Yes <input type="checkbox"/> <sub>2</sub> No	<input type="checkbox"/> <sub>1</sub> Yes <input type="checkbox"/> <sub>2</sub> No
13. Encourage the patient to participate in support groups.	<input type="checkbox"/> <sub>1</sub> Yes <input type="checkbox"/> <sub>2</sub> No	<input type="checkbox"/> <sub>1</sub> Yes <input type="checkbox"/> <sub>2</sub> No	<input type="checkbox"/> <sub>1</sub> Yes <input type="checkbox"/> <sub>2</sub> No	<input type="checkbox"/> <sub>1</sub> Yes <input type="checkbox"/> <sub>2</sub> No
14. Refer the patient to health and community services.	<input type="checkbox"/> <sub>1</sub> Yes <input type="checkbox"/> <sub>2</sub> No	<input type="checkbox"/> <sub>1</sub> Yes <input type="checkbox"/> <sub>2</sub> No	<input type="checkbox"/> <sub>1</sub> Yes <input type="checkbox"/> <sub>2</sub> No	<input type="checkbox"/> <sub>1</sub> Yes <input type="checkbox"/> <sub>2</sub> No
15. Conduct followup home visit.	<input type="checkbox"/> <sub>1</sub> Yes <input type="checkbox"/> <sub>2</sub> No	<input type="checkbox"/> <sub>1</sub> Yes <input type="checkbox"/> <sub>2</sub> No	<input type="checkbox"/> <sub>1</sub> Yes <input type="checkbox"/> <sub>2</sub> No	<input type="checkbox"/> <sub>1</sub> Yes <input type="checkbox"/> <sub>2</sub> No
16. Conduct followup phone call.	<input type="checkbox"/> <sub>1</sub> Yes <input type="checkbox"/> <sub>2</sub> No	<input type="checkbox"/> <sub>1</sub> Yes <input type="checkbox"/> <sub>2</sub> No	<input type="checkbox"/> <sub>1</sub> Yes <input type="checkbox"/> <sub>2</sub> No	<input type="checkbox"/> <sub>1</sub> Yes <input type="checkbox"/> <sub>2</sub> No
17. Write down what you discussed during the home visit or phone call.	<input type="checkbox"/> <sub>1</sub> Yes <input type="checkbox"/> <sub>2</sub> No	<input type="checkbox"/> <sub>1</sub> Yes <input type="checkbox"/> <sub>2</sub> No	<input type="checkbox"/> <sub>1</sub> Yes <input type="checkbox"/> <sub>2</sub> No	<input type="checkbox"/> <sub>1</sub> Yes <input type="checkbox"/> <sub>2</sub> No
18. Meet with your supervisor on a regular basis.	<input type="checkbox"/> <sub>1</sub> Yes <input type="checkbox"/> <sub>2</sub> No	<input type="checkbox"/> <sub>1</sub> Yes <input type="checkbox"/> <sub>2</sub> No	<input type="checkbox"/> <sub>1</sub> Yes <input type="checkbox"/> <sub>2</sub> No	<input type="checkbox"/> <sub>1</sub> Yes <input type="checkbox"/> <sub>2</sub> No
19. File notes in the patient's chart.	<input type="checkbox"/> <sub>1</sub> Yes <input type="checkbox"/> <sub>2</sub> No	<input type="checkbox"/> <sub>1</sub> Yes <input type="checkbox"/> <sub>2</sub> No	<input type="checkbox"/> <sub>1</sub> Yes <input type="checkbox"/> <sub>2</sub> No	<input type="checkbox"/> <sub>1</sub> Yes <input type="checkbox"/> <sub>2</sub> No
20. Other: _____	<input type="checkbox"/> <sub>1</sub> Yes <input type="checkbox"/> <sub>2</sub> No	<input type="checkbox"/> <sub>1</sub> Yes <input type="checkbox"/> <sub>2</sub> No	<input type="checkbox"/> <sub>1</sub> Yes <input type="checkbox"/> <sub>2</sub> No	<input type="checkbox"/> <sub>1</sub> Yes <input type="checkbox"/> <sub>2</sub> No

# Recording Log

## (for Strategies 1, 2a, 2b, and 3)

---

Strategy	Use This Form	Information
1. Train the Trainer	Attendance Record	<input type="checkbox"/> Number of participants trained _____ <input type="checkbox"/> Number of sessions taught _____
	Feedback Form	<input type="checkbox"/> Number and percentage of participants who rate the training “good” or better _____ <input type="checkbox"/> Number and percentage of participants who report that they “will” or “most likely will” change their health habits _____
	Community Health Workers’ Train the Trainer Posttest only	<input type="checkbox"/> Number and percentage of participants using the “Healthy Heart, Healthy Family” manual 30 days after the training _____ <input type="checkbox"/> Types of activities participants have done 30 days after the training _____

# Recording Log (for Strategies 1, 2a, 2b, and 3) *(continued)*

Strategy	Use This Form	Information
<b>2. Community Education</b> <b>a. Teach the educational manual only.</b>	Attendance Record	<input type="checkbox"/> Number of participants counseled/taught _____ <input type="checkbox"/> Number of sessions taught _____
	My Health Habits Posttest	<input type="checkbox"/> Number of participants satisfied with project _____ <input type="checkbox"/> Number of persons who shared information about the project _____
<b>b. Teach the educational manual and screen program participants.</b>	Attendance Record	<input type="checkbox"/> Number of participants counseled/taught _____ <input type="checkbox"/> Number of sessions taught _____
	My Health Habits Posttest	<input type="checkbox"/> Number of participants satisfied with project _____ <input type="checkbox"/> Number of participants who shared information about the project _____
	Screening Form	<input type="checkbox"/> Number of participants screened _____ <input type="checkbox"/> Number of participants with elevated clinical values _____ <input type="checkbox"/> Number of participants referred to a health care professional _____ <input type="checkbox"/> Number of participants who actually followed up with a health care professional _____

# Recording Log (for Strategies 1, 2a, 2b, and 3) *(continued)*

Strategy	Use This Form	Information																																																											
<b>3. Lifestyle and Clinical Management</b>	Attendance Record	<input type="checkbox"/> Number of patients counseled/taught _____ <input type="checkbox"/> Number of sessions taught _____																																																											
	My Health Habits Posttest	<input type="checkbox"/> Number of participants satisfied with project _____ <input type="checkbox"/> Number of persons who shared information about the project _____																																																											
	Clinical Measures and Followup Form	<table style="width: 100%; border-collapse: collapse;"> <tr> <td style="width: 60%;"></td> <td style="text-align: center;">Baseline</td> <td style="text-align: center;">6 months</td> <td style="text-align: center;">12 months</td> </tr> <tr> <td><input type="checkbox"/> Number of patients screened</td> <td>_____</td> <td>_____</td> <td>_____</td> </tr> <tr> <td><input type="checkbox"/> Number of patients with:</td> <td>_____</td> <td>_____</td> <td>_____</td> </tr> <tr> <td>    <input type="checkbox"/> Prehypertension</td> <td>_____</td> <td>_____</td> <td>_____</td> </tr> <tr> <td>    <input type="checkbox"/> High blood pressure</td> <td>_____</td> <td>_____</td> <td>_____</td> </tr> <tr> <td>    <input type="checkbox"/> High blood cholesterol</td> <td>_____</td> <td>_____</td> <td>_____</td> </tr> <tr> <td>    <input type="checkbox"/> Prediabetes</td> <td>_____</td> <td>_____</td> <td>_____</td> </tr> <tr> <td>    <input type="checkbox"/> High blood glucose</td> <td>_____</td> <td>_____</td> <td>_____</td> </tr> <tr> <td>    <input type="checkbox"/> Body mass index (BMI) of 25 or more</td> <td>_____</td> <td>_____</td> <td>_____</td> </tr> <tr> <td>    <input type="checkbox"/> Waist measurement greater than 35 inches (88 cm) for women</td> <td>_____</td> <td>_____</td> <td>_____</td> </tr> <tr> <td>    <input type="checkbox"/> Waist measurement greater than 40 inches (102 cm) for men</td> <td>_____</td> <td>_____</td> <td>_____</td> </tr> <tr> <td><input type="checkbox"/> Number of patients who are taking medications for:</td> <td>_____</td> <td>_____</td> <td>_____</td> </tr> <tr> <td>    <input type="checkbox"/> High blood pressure</td> <td>_____</td> <td>_____</td> <td>_____</td> </tr> <tr> <td>    <input type="checkbox"/> High blood cholesterol</td> <td>_____</td> <td>_____</td> <td>_____</td> </tr> <tr> <td>    <input type="checkbox"/> Diabetes</td> <td>_____</td> <td>_____</td> <td>_____</td> </tr> </table>		Baseline	6 months	12 months	<input type="checkbox"/> Number of patients screened	_____	_____	_____	<input type="checkbox"/> Number of patients with:	_____	_____	_____	<input type="checkbox"/> Prehypertension	_____	_____	_____	<input type="checkbox"/> High blood pressure	_____	_____	_____	<input type="checkbox"/> High blood cholesterol	_____	_____	_____	<input type="checkbox"/> Prediabetes	_____	_____	_____	<input type="checkbox"/> High blood glucose	_____	_____	_____	<input type="checkbox"/> Body mass index (BMI) of 25 or more	_____	_____	_____	<input type="checkbox"/> Waist measurement greater than 35 inches (88 cm) for women	_____	_____	_____	<input type="checkbox"/> Waist measurement greater than 40 inches (102 cm) for men	_____	_____	_____	<input type="checkbox"/> Number of patients who are taking medications for:	_____	_____	_____	<input type="checkbox"/> High blood pressure	_____	_____	_____	<input type="checkbox"/> High blood cholesterol	_____	_____	_____	<input type="checkbox"/> Diabetes	_____	_____
	Baseline	6 months	12 months																																																										
<input type="checkbox"/> Number of patients screened	_____	_____	_____																																																										
<input type="checkbox"/> Number of patients with:	_____	_____	_____																																																										
<input type="checkbox"/> Prehypertension	_____	_____	_____																																																										
<input type="checkbox"/> High blood pressure	_____	_____	_____																																																										
<input type="checkbox"/> High blood cholesterol	_____	_____	_____																																																										
<input type="checkbox"/> Prediabetes	_____	_____	_____																																																										
<input type="checkbox"/> High blood glucose	_____	_____	_____																																																										
<input type="checkbox"/> Body mass index (BMI) of 25 or more	_____	_____	_____																																																										
<input type="checkbox"/> Waist measurement greater than 35 inches (88 cm) for women	_____	_____	_____																																																										
<input type="checkbox"/> Waist measurement greater than 40 inches (102 cm) for men	_____	_____	_____																																																										
<input type="checkbox"/> Number of patients who are taking medications for:	_____	_____	_____																																																										
<input type="checkbox"/> High blood pressure	_____	_____	_____																																																										
<input type="checkbox"/> High blood cholesterol	_____	_____	_____																																																										
<input type="checkbox"/> Diabetes	_____	_____	_____																																																										
	Community Health Worker's Activities Form	<input type="checkbox"/> Number of patients contacted at first encounter _____ <input type="checkbox"/> Number of patients contacted at 3 months _____ <input type="checkbox"/> Number of patients contacted at 6 months _____ <input type="checkbox"/> Number of patients contacted at 12 months _____ <input type="checkbox"/> Listed the activities community health workers conducted at first encounter, at 3 months, at 6 months, and at 12 months																																																											

# Develop an Evaluation Workplan for Your Project

Write your workplan for evaluating each project using the guide below.

## Project 1: Training Community Health Workers To Promote the Healthy Heart, Healthy Family Project in Your Community

- Your agency has agreed to conduct the Healthy Heart, Healthy Family Train the Trainer workshop for several agencies in the community. Your agency will train 25 community health workers from community agencies that have requested it.
- Your supervisor asks you and two other community health workers to plan the Train the Trainer workshop and to develop the evaluation plan.

### Setting:

Who will be your target audience?	What strategy will you use?	List the forms you will use to collect the data.	Describe the activities for carrying out the strategy (sample questions are given below)	Describe who will handle the data.	Who will write the report?
			How will you recruit participants?	Who will collect the data?	
			When will you schedule the classes?	Who will enter the data?	
			Who will teach the classes?	Who will analyze the collected data?	



## Develop an Evaluation Workplan for Your Project *(continued)*

Write your workplan for evaluating each project using the guide below.

### Project 2: Helping Community Members Make Heart Healthy Lifestyle Changes

- Your community-based organization is in Queens, New York.
- Your supervisor asks you to help develop the evaluation plan for the Healthy Heart, Healthy Family community project.
- The project is for adults aged 30 to 60.
- The goal is to recruit, teach, and increase the knowledge, attitudes, and skills of the community members attending your project.

#### Setting:

Who will be your target audience?	What strategy will you use?	List the forms you will use to collect the data.	Describe the activities for carrying out the strategy (sample questions are given below)	Describe who will handle the data.	Who will write the report?
			<p>How will you recruit participants?</p> <p>When will you schedule the classes?</p> <p>Who will teach the classes?</p>	<p>Who will collect the data?</p> <p>Who will enter the data?</p> <p>Who will analyze the collected data?</p>	

## Develop an Evaluation Workplan for Your Project *(continued)*

Write your workplan to evaluate a project using the guide below.

### Project 3: Helping Patients Manage Their Risk Factors for Heart Disease and Make Lifestyle Changes

- Your clinic is located in Honolulu, Hawaii.
- Your clinic has decided to get involved in a complete project on heart health to help patients change their behaviors and lower their clinical measures.
- You and two other community health workers attended a community health workers conference to receive the Healthy Heart, Healthy Family training.
- Now, your supervisor wants your group to develop activities and an evaluation plan for the project.

#### Setting:

Who will be your target audience?	What strategy will you use?	List the forms you will use to collect the data.	Describe the activities for carrying out the strategy (sample questions are given below)	Describe who will handle the data.	Who will write the report?
			How will you recruit participants?  When will you schedule the classes?  Who will teach the classes?	Who will collect the data?  Who will enter the data?  Who will analyze the collected data?	



# a p p e n d i x

## Activities for Training Community Health Workers



The “Healthy Heart, Healthy Family” manual can be used to train community health workers about heart health. The manual can also be used as a guide to conduct sessions to educate community members about heart health.

Trained community health workers can train other community health workers. Trained community health workers can also conduct heart health education sessions in the community to promote heart healthy behaviors, or they can conduct sessions in clinics to help patients control their risk factors for heart disease.

**Part 1** of this appendix offers activities to help community health workers develop skills to present sessions from the “Healthy Heart, Healthy Family” manual to community groups. The handouts in this section offer suggestions for leading groups, as well as opportunities for group members to practice teaching session topics during the training. The sample flyer on pages xxiii and 505 can be used to help groups publicize their community health worker training sessions. This flyer can be posted in local clinics and organizations, and community leaders can help find people who want to attend the training.

**Part 2** provides a series of special activities and additional information that community health workers can use to enhance learning during the training. These special activities can also be offered separately at community events such as health fairs and health festivals.

### **Part 1**

### **Training Session: Preparing To Make a Presentation**



**Note:** If your goal is to train community health workers, deliver the following session after you have finished Sessions 1 and 7.

Effective community health workers must have good presentation skills. This section presents information on how a community health worker can prepare to teach the Healthy Heart, Healthy Family training.

### At the end of Session 1

■ **Say:**

When you complete the Healthy Heart, Healthy Family training, you will be able to conduct your own project for groups in your community. As a community health worker, you will not be giving medical advice. You will give information and support to encourage others to live healthier lives and to use health services that are available in their communities.



**Note:** Give each community health worker the “Tips To Teach the ‘Healthy Heart, Healthy Family’ Manual” handout (page 502) and the “Seven Golden Rules for Teaching Groups” handout (page 503).



■ **Say:**

Now we will review some steps that will help you prepare an effective and interesting presentation of the “Healthy Heart, Healthy Family” manual.

■ **Say:**

Let’s review the “Tips To Teach the ‘Healthy Heart, Healthy Family’ Manual” handout and the “Seven Golden Rules for Teaching Groups” handout. I recommend that you use these materials when you prepare your presentation and teach the “Healthy Heart, Healthy Family” manual.

## Teaching Practice

Community health workers can gain confidence as presenters by practicing teaching a session. Listed below are two ways that your group can practice during the training: (1) group members can present a complete session, or (2) they can make short presentations on topics from each session. Choose the method that works best for your group.

### 1. Presenting a Session

This activity gives community health workers the opportunity to practice teaching the sessions of the “Healthy Heart, Healthy Family” manual. At the end of Session 7, divide the participants into two groups. Assign one group to present Session 9 and one group to present Session 10.

**Allow** the groups 30 minutes to practice at the end of Sessions 7 and 8. Give each group the handouts and other supplies needed to teach each session. The group not teaching will offer suggestions to the presenters about what was done well and what could be improved.

#### At the end of Session 7

■ **Say:**

Now you will have the chance to be the trainers. Let’s divide into two groups. One group will practice teaching Session 9, “Eat Heart Healthy on a Budget.” The other group will practice teaching Session 10, “Be Heart Healthy: Enjoy Living Smoke Free.”

■ **Say:**

Each group now has 30 minutes to review the assigned session and decide how to present the activities. You can use this time to divide the sections of the session among the members of your group.

■ **Say:**

You will also have 30 minutes at the end of Session 8, which is next week, to continue practicing. After this, you will teach Sessions 9 and 10. Each group will have 1 hour to teach each session.

## 2. Presenting a Topic from a Session

For this second method, group members will make presentations on specific topics from each session. Each participant may make a 5- to 10-minute presentation individually, or in a team of two, on a session topic covered during the training. Present this activity at the end of Session 7 by asking the community health workers to choose the topic they will present and by giving them time to practice.

### At the end of Session 7

■ **Say:**

At the end of Sessions 8, 9, and 10, each of you will make a short presentation on your own or with another group member. Each presentation will cover a topic from the manual and will last 5 to 10 minutes.

- **Give** participants the “Healthy Heart, Healthy Family: Topics for Practice” handout (page 504).



■ **Say:**

Here is a list of topics from which you can choose. I will give you a few minutes to select your topic. You can choose a partner if you wish to work in pairs. Then we’ll make a list of the topics and presenters. Do not be nervous. We are all here to learn and practice in a safe environment.



**Note:** A list of topics to include appears below.

### **Healthy Heart, Healthy Family: Topics for Practice**

- How the Heart Works (Session 1)
- Heart Disease Risk Factor Activity (Session 1)
- What Are the Warning Signs of a Heart Attack? (Session 2)
- Benefits of Physical Activity (Session 3)
- Types of Physical Activity (Session 3)
- Lowering High Blood Pressure (Session 4)
- Shake the Salt and Sodium Habit (Session 4)

- Facts About Blood Pressure and Stroke (Session 4)
- Metabolic Syndrome and Your Health (Session 5)
- Nutrition Facts Label Activity—Fats (Session 5)
- Facts About Saturated Fat, *Trans* Fat, and Cholesterol (Session 5)
- Cooking With Less Saturated Fat Activity (Session 5)
- What Is a Healthy Weight? Activity (Session 6)
- The Healthy Way To Lose Weight (Session 6)
- ABCs of Diabetes Control (Session 7)
- Think Before You Drink: Hidden Sugar in Common Beverages (Session 7)
- The Traditional Filipino Diet (Session 8)
- Eating in a Heart Healthy Way Even When There Is Little Time: Busy Times (Session 9)
- Eating in a Heart Healthy Way Even When There Is Little Time: Eating Out (Session 9)
- Saving Money on Your Food Bill (Session 9)
- Smoking Harms You (Session 10)
- Quitting Smoking (Session 10)

■ **Say:**

Now, please tell me which topics you want to present.

- **Write** each group member's name (and his or her partner's name, if applicable) beside the topic.



**Note:** If too many people choose the same topics, you should ask them to choose others.



■ **Say:**

Remember to use the “Tips To Teach the ‘Healthy Heart, Healthy Family’ Manual” handout (page 502) and the “Seven Golden Rules for Teaching Groups” handout (page 503) when you present your topics.

**Note:** Decide which group members will present their topics at the end of Session 8, at the end of Session 9, and at the end of Session 10.

**Note:** Now allow 30 minutes for group members to review their topics, ask questions, or practice their presentations.

**At the end of Sessions 8, 9, and 10**

**Note:** When you finish presenting each of Sessions 8, 9, and 10, assigned group members should present their topics.

■ **Say:**

Now we will present our topics. Each person or team will present for about 5 minutes. This exercise will give you a chance to practice your teaching skills and get feedback. Each time you present, you will become more comfortable and learn new ways to get people involved.

- **Ask** a group member or pair to make the first presentation. After the presentation, **allow** 3 to 5 minutes for questions or comments about what was done well and what can be improved. **Thank** group members, and give positive comments. Politely **correct** any wrong information. Then **ask** another group member or pair to present.

**Follow** these instructions for each presentation, until all group members have finished presenting their topics.

■ **Say:**

Your presentations have shown how much you have learned about heart health. I hope you will use every opportunity to spread the word—Filipino American families can make changes now to reduce their risk for heart disease. Community health workers—like you—are important to helping our families and communities live healthy lifestyles.

### 3. You May Want To Practice More

#### ■ Say:

Here are some ideas to build your confidence and give you more practice:

- Observe an experienced trainer or community health worker while he or she teaches a session or the entire project.
- Schedule an opportunity for each community health worker to present a full session to other community health workers.
- Team-teach a session or the entire project to a community group with the help of a more experienced trainer. Ask for assistance from your project coordinator.

# Tips To Teach the “Healthy Heart, Healthy Family” Manual

---

## Before Each Session

- Review the manual carefully several times.
- Review information about your audience (for example, their levels of education, years as community health workers, areas of expertise, or how open they are to new health information).
- Practice teaching in front of family or friends using all your materials.
- Gather materials and equipment you will need (posters, music, videotapes, handouts, extension cords, television monitor, VCR/VHS, picture cards, markers, measuring tape, masking tape, and food items). If the room has a blackboard, make sure there is plenty of chalk and an eraser. If no blackboard is available, you will need flipchart-size pieces of paper and additional markers.

## The Day of the Session

- Arrive at least 30 minutes before the start of the session.
- Set up chairs and tables in a U-shape so you can get the group more involved.
- Find the electrical outlets and light switches.
- Set up audiovisual equipment.
- Set videotapes to the place on the tape where you need to start them.
- Place posters where the audience can see them. Make sure not to damage the walls.
- Put the handouts in the order you will give them out. Make sure you have enough copies for everyone.
- Set up any activities or snacks that you have planned.

## After the Session

- Leave the room clean and arranged the way you found it.
- Collect all forms.
- Thank everyone for coming.

# Seven Golden Rules for Teaching Groups

---

- 1. Maintain eye contact with everyone.**
- 2. Speak so that everyone can hear.**  
Talk with a clear, strong, and kind voice.
- 3. Show your enthusiasm.** Move around. Use hand gestures.
- 4. Keep track of time.** Wear a watch, or have a clock in the room. Plan your presentation so that you do not have to rush. Do not let the class run too long.
- 5. Show interest in the group members.**
  - Greet them when they come in.
  - Tell them you value their time and attendance.
  - Listen to what people say.
  - Talk simply and to the point. Give clear, short answers.
  - Help them to set goals.
  - Stay calm and use humor. Focus on the positive.
  - End with a review of the most important points. Thank them for coming.
- 6. Try to have everyone participate.**  
People tend to learn more when they are involved. Try not to lecture.
  - Ask questions. Praise correct answers. Correct wrong information politely.
  - Answer questions. Be honest. Find out the answers to questions you cannot answer.
- 7. Pay attention to content.** Your presentation must provide correct information.

# Healthy Heart, Healthy Family: Topics for Practice

---

- How the Heart Works (Session 1)
- Heart Disease Risk Factor Activity (Session 1)
- What Are the Warning Signs of a Heart Attack? (Session 2)
- Benefits of Physical Activity (Session 3)
- Types of Physical Activity (Session 3)
- Lowering High Blood Pressure (Session 4)
- Shake the Salt and Sodium Habit (Session 4)
- Facts About Blood Pressure and Stroke (Session 4)
- Metabolic Syndrome and Your Health (Session 5)
- Nutrition Facts Label Activity—Fats (Session 5)
- Facts About Saturated Fat, *Trans* Fat, and Cholesterol (Session 5)
- Cooking With Less Saturated Fat Activity (Session 5)
- What Is a Healthy Weight? Activity (Session 6)
- The Healthy Way To Lose Weight (Session 6)
- ABCs of Diabetes Control (Session 7)
- Think Before You Drink: Hidden Sugar in Common Beverages (Session 7)
- The Traditional Filipino Diet (Session 8)
- Eating in a Heart Healthy Way Even When There Is Little Time: Busy Times (Session 9)
- Eating in a Heart Healthy Way Even When There Is Little Time: Eating Out (Session 9)
- Saving Money on Your Food Bill (Session 9)
- Smoking Harms You (Session 10)
- Quitting Smoking (Session 10)

# Join the Fight Against Heart Disease in the Filipino American Community



**Participate in a Healthy Heart, Healthy Family Training Workshop for Community Health Workers**

## Learn About Heart Health

The Healthy Heart, Healthy Family training workshop will help you gain the knowledge, skills, and motivation to help you take action against heart disease.

## Teach Others About Heart Health

The training workshop will also help you learn teaching methods. You will be introduced to educational materials that you can use to lead sessions about heart health in your community using the “Healthy Heart, Healthy Family” manual.

**The next training will be held:**

**Date:** \_\_\_\_\_ **Time:** \_\_\_\_\_

**Location:** \_\_\_\_\_

**To register, contact:** \_\_\_\_\_

**Upon completion of training, each participant will receive a certificate.**



**U.S. Department of Health and Human Services**  
National Institutes of Health



**National Heart  
Lung and Blood Institute**  
People Science Health

## Part 2

### Additional Information and Activities

Community health workers may add activities to the “Healthy Heart, Healthy Family” manual sessions to help with training. This section of the appendix offers instructions on how to present five additional activities to the group members.

#### Activity 1: Face The Heart Truth



**Note:** You can review The Heart Truth information with group members and tell them how they can participate. The Heart Truth is a national awareness campaign for women about heart disease.

#### The Heart Truth for Women

- Heart disease is a serious health problem for Filipinas and is one of the leading causes of death. In the United States, it is the #1 killer of women, regardless of race. It affects women at younger ages more than most people think, and the risk increases in middle age.
- Heart disease can diminish health and the ability to do even simple activities like climbing stairs. It can decrease your quality of life. Two-thirds of women who have heart attacks never fully recover. If you have a heart attack, your risk of having another one increases.



#### Act Now To Protect Your Heart

- Start protecting your heart now by learning about The Heart Truth at [www.hearttruth.gov](http://www.hearttruth.gov). You’ll find out how and why women everywhere are embracing The Heart Truth’s Red Dress, the national symbol for women that raises awareness of heart disease, which is the #1 killer of women.
- Celebrate a new tradition. The first Friday of February is National Wear Red Day. Promote this event in your community. Participate by showing off your favorite red dress, shirt, or tie and by wearing the Red Dress pin. Visit [www.hearttruth.gov](http://www.hearttruth.gov) to order your own official Red Dress pin.

## Activity 2: How To Organize a Walking Club



Walking is an excellent form of physical activity. It is fun and easy, and it builds good health and well-being. Walking is inexpensive, and you do not need special equipment.

### Promote the benefits of walking as a group.

- It is more fun to walk as a group.
- Team members help each other to keep the pace and stick to the project.
- Walking gives you time to spend with friends and meet new friends who are also interested in being active.
- You can develop goals and work together to achieve them.
- Your club can plan fun activities and themes, which increase participation.
- Walking is an easy activity to begin.

### How?

- Form a group of people who are interested in starting a walking club.
- Get the group together to share ideas and set goals.
- Plan your project. Use a calendar to mark the day, place, and time when you will meet. Also, write down the distance you want to walk each day. Remember to make changes from time to time and to keep your activities fun and challenging.
- Announce the start of the club during the Healthy Heart, Healthy Family classes, and invite the group members to bring their friends and family. Besides word of mouth, use interesting ways to advertise, including posters, church bulletins, calendars, newsletters, and newspapers.
- Ask club members to help you create a slogan or catchy name for your club.



## Where?

- Pick a location where your club will walk, perhaps in the surrounding neighborhood where you hold your classes. You may change the route to keep it fun, but you should always meet at the same time and in the same place.
- Look for well-lit areas with sidewalks. If there is a school nearby, tracks are usually open to the public.
- You can also walk inside a mall when it's too cold, too wet, or too hot outside.

## What?

- Plan your activities, and use your imagination!
- Encourage different members to lead the group.
- Have special walk days each month to highlight themes, such as American Heart Month, Filipino Heritage Month (in June), Asian Pacific American Heritage Month (in May), Mother's Day, and other traditional celebrations.
- Create daily or weekly theme walks, such as nature walks, discovery walks, or fitness walks.
- Encourage participants to warm up, cool down, and stretch to avoid injuries. (See the "Start Moving With Stretching Activities" handout in Session 3 on pages 86-88.)
- Use a calendar or notebook to record personal walks and distances.
- Motivate group members to keep personal records and to challenge themselves to improve.

## When?

- Decide when to walk (for example, before or after class or during weekend mornings or afternoons).

## Do Not Forget

- Stay alert. Be familiar with your surroundings.
- Encourage walkers to dress appropriately and to bring plenty of water.
- Advise participants on the dangers of wrapping themselves with plastic or wearing clothing that is too heavy. Tell them not to do this because it is dangerous. (See Session 3, page 71, for more information.)
- Make sure that chatting does not interfere with the walking pace. Encourage group members to socialize, but also encourage them to keep moving.

### Activity 3: Nutrition Displays



Nutrition displays are a great way to teach about nutrition. They visually encourage participants to learn about healthy food choices. Nutrition displays make a class or presentation more interesting, and they can be used with this manual. Examples of nutrition displays that you can create and use along with the nutrition activities in Sessions 4 through 9 are in this appendix on pages 511–516.

- Three nutrition displays are recommended for use with the manual:
  1. Fat Matters—But Calories Count  
Use during Session 5, “Be Heart Smart: Keep Your Cholesterol in Check.”
  2. How Much Sugar and How Many Calories Are in Your Favorite Drink?  
Use during Session 7, “Protect Your Heart: Prevent and Control Diabetes.”
  3. Making the Best Choice in Fast Food Places  
Use after Session 8, “Welcome Heart Healthy Eating into Your Home.”
- Prepare displays to teach participants about the food choices they may have. Use displays in settings such as health fairs, waiting room areas, schools, worksite cafeterias, community health centers, and sites of the Special Supplemental Nutrition Project for Women, Infants, and Children (WIC).

## What you need:

- One sheet of poster board (20 inches by 30 inches)
- Food pictures or food models
- Plastic spoons, preferably colored
- White clay, Velcro®, glue, markers
- Sugar cubes and manila file folders (for use in the sugar displays, as shown in the picture on page 512)

### 1. Fat Matters—But Calories Count

This nutrition display demonstrates the number of teaspoons of actual fat in foods. For example, you can compare fried chicken with baked or grilled chicken with the skin removed. Calculate the number of teaspoons by dividing the number of fat grams by four. For example, a food with 20 grams of fat has 5 teaspoons of fat (20 grams divided by 4).

#### Some foods that can be compared are:

Pork <i>Longanisa</i> , sweet, 2 links	.....	6¾ teaspoons of fat (27 grams)
3 ounces of lean pork tenderloin	.....	1¼ teaspoon of fat (5 grams)

3½ ounces of chicken breast with skin (fried in 1 tablespoon oil)	.....	4¾ teaspoons of fat (19 grams)
3½ ounces of skinless chicken breast (broiled).	.....	1 teaspoon of fat (4 grams)
Chicken <i>Siopao</i>	.....	1 teaspoon of fat (4 grams)

# Fat Matters—But Calories Count!



## **Pork *Longanisa*, sweet (2 links)**

Calories: 210  
Total fat: 27 grams  
Saturated Fat: 6 grams



**27 grams of total fat =  
6<sup>3</sup>/<sub>4</sub> teaspoons of fat**



## **Lean Pork Tenderloin (3 ounces)**

Calories: 140  
Total fat: 5 grams  
Saturated fat: 1 gram



**5 grams of total fat =  
1<sup>1</sup>/<sub>4</sub> teaspoons of fat**

## 2. How Much Sugar and How Many Calories Are in Your Favorite Drink?

This display is used to demonstrate how much sugar and how many calories are in common drinks.

- Cut a manila file folder in half, and fold each portion in half to make a card.
- Write the name of the drink on one side. On the other side, write the number of calories, grams of sugar, and teaspoons of sugar in the drink. Glue the sugar cubes onto the folder to show the number of teaspoons of sugar in each drink.
- Use the “How Much Sugar and How Many Calories Are in Your Favorite Drink?” handout (in Session 7, page 278) to find the number of calories, grams of sugar, and teaspoons of sugar in common drinks.

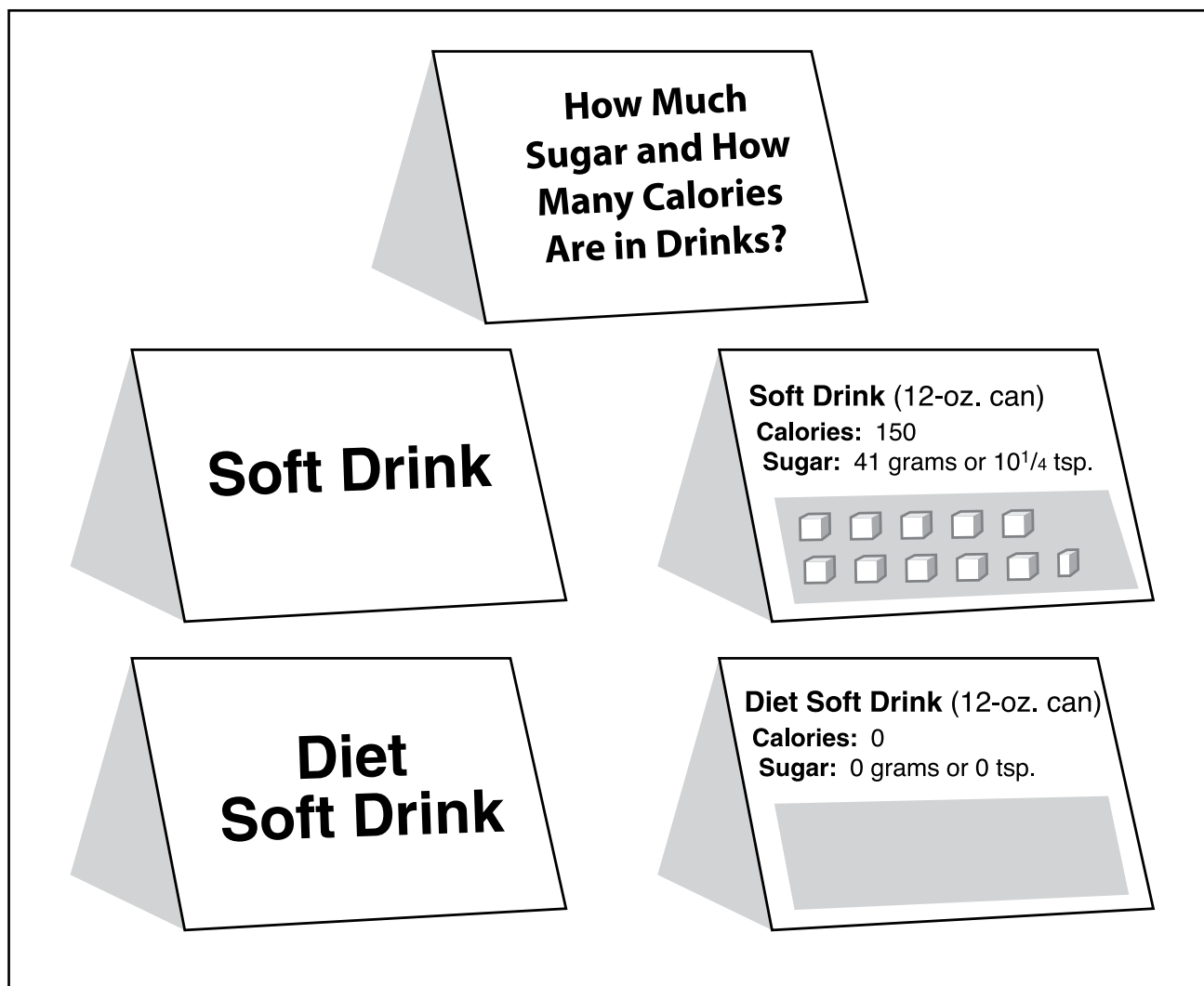

# Rethink Your Drink

**Q:** If you drink one 12-ounce can of regular soda every day for 1 year, how much sugar is that in a year?

**A:** 30 pounds of sugar



**Q:** How much weight would a person lose in a year after switching from regular soda to water or calorie-free beverages?

**A:** About 15½ pounds\*

\* Based on 150 calories in an average 12-ounce can of soda

### 3. Making the Best Choice in Fast Food Places

This display shows you how to make healthy choices at fast food restaurants. Nutrition information can be found on most company Web sites, and most fast food places have nutrition brochures available.

Two sample meals are shown below.

#### **HIGH-Calorie and HIGH-Fat Menu Choices**

<b>Food Items</b>	<b>Calories</b>	<b>Total Fat (g)</b>	<b>Saturated Fat (g)</b>
Double meat cheeseburger	1,120	76	30
Medium french fries	360	18	5
Medium chocolate shake	500	8	5
<b>Total</b>	<b>1,980</b>	<b>102</b>	<b>40</b>

102 grams of total fat = 25½ teaspoons of fat

#### **LOWER-Calorie and LOWER-Fat Menu Choices**

<b>Food Items</b>	<b>Calories</b>	<b>Total Fat (g)</b>	<b>Saturated Fat (g)</b>
Grilled chicken sandwich, no mayonnaise	330	7	1
Garden salad	25	0	0
Light salad dressing	50	5	1
Low-fat (1%) milk	110	2	2
<b>Total</b>	<b>515</b>	<b>14</b>	<b>4</b>

14 grams of total fat = 3½ teaspoons of fat

The food-choice sign on page 515 can be made into a table-tent sign by gluing the sign to a manila folder.

# Making the Best Choice:

## How To Choose a Healthier Fast Food Meal



### High-Calorie Menu Choice:

102 grams of total fat = 25<sup>1</sup>/<sub>2</sub> teaspoons of fat

Food Items	Calories	Total Fat	Saturated Fat
Double meat cheeseburger	1,120	76 g	30 g
Medium french fries	360	18 g	5 g
Medium chocolate milkshake	500	8 g	5 g
<b>Total</b>	<b>1,980</b>	<b>102 g</b>	<b>40 g</b>



### Lower-Calorie Menu Choice:

14 grams of total fat = 3<sup>1</sup>/<sub>2</sub> teaspoons of fat

Food Items	Calories	Total Fat	Saturated Fat
Grilled chicken sandwich, no mayonnaise	330	7 g	1 g
Salad, low-fat dressing	75	5 g	1 g
Low-fat (1%) milk	110	2 g	2 g
<b>Total</b>	<b>515</b>	<b>14 g</b>	<b>4 g</b>



# Making the Best Choice:

## How To Choose a Healthier Fast Food Meal *(Continued)*

---

### **Making the Best Choice**

#### **How To Choose a Healthier Fast Food Meal**

- Choose a sandwich without mayonnaise or special sauce.
- Order sandwiches without cheese. Choose a regular sandwich, not one with double meat or with more than two pieces of bread.
- Choose not to supersize.
- Have water, unsweetened iced tea, or a diet soft drink instead of a regular soft drink or milkshake.
- Choose a green salad with low-fat or fat-free dressing instead of french fries or onion rings.
- Plan ahead—have a healthy, low-fat breakfast and lunch if you plan to eat out for dinner.

## Activity 4: Take Time for Sleep—Additional Presentation



Most adults need 7 to 8 hours of sleep each night. School-aged children and teens need at least 9 hours of sleep a night. Like eating healthy and being physically active, getting a good night's sleep is important to your heart health and your mood, and it is important when you are completing your daily activities. Not getting enough sleep can cause problems.

Sleep disorders, such as sleep apnea, can disturb how well you sleep and leave you sleepy the next day. In people with sleep apnea, breathing stops briefly or becomes very shallow during sleep. They usually snore loudly and often.

If you do not get enough sleep each night, or if you have sleep apnea that is not treated, you may be at increased risk for becoming overweight or developing high blood pressure, heart disease, or diabetes.

### The Dos and Don'ts of Getting a Good Night's Sleep

- ✔ **Do** go to bed and wake up at the same time each day—even on weekends.
- ✔ **Do** physical activity, but not too late in the day.
- ✔ **Do** relax before bed—read or listen to music.
- ✔ **Do** take a hot bath before bed—it can help you relax.
- ✔ **Do** get rid of things that might distract you from sleep noises, bright lights, an uncomfortable bed, or a TV or computer in the bedroom.
- ✔ **Do** keep the room temperature cool.
- ✔ **Do** see a doctor if you have trouble sleeping. If you are tired during the day, even after spending enough time in bed at night, you may have a sleep disorder.
- ✖ **Do not** have caffeine or nicotine after 3 p.m.
- ✖ **Do not** eat large meals or drink beverages late at night.
- ✖ **Do not** take medicines that delay or disrupt your sleep. Check with your doctor about your prescribed medicines if you have trouble sleeping.
- ✖ **Do not** take naps after 3 p.m.
- ✖ **Do not** lie in bed awake. Get up and do some relaxing activity until you feel sleepy.

To learn more about sleep and sleep disorders, visit the National Heart, Lung, and Blood Institute (NHLBI) Web site at [www.nhlbi.nih.gov](http://www.nhlbi.nih.gov), and click on “Sleep.”

## Activity 5: Heart Healthy Cooking Demonstrations



Cooking demonstrations can be an important part of group discussions. A cooking demonstration can show participants how to prepare foods that still taste good but include less saturated fat, *trans* fat, cholesterol, and salt and sodium. Most people like to eat, especially traditional food prepared the traditional way, and they will be interested in learning how to prepare food in a heart healthy way. This section gives you more information about how to use cooking demonstrations as a part of the training and how to make sure they go smoothly.

### 1. Recruiting a Food Demonstration Facilitator

- If you are not going to conduct the food demonstration yourself, you can recruit a registered dietitian by contacting the local health department, the local American Dietetic Association, or the local Cooperative Extension Service office.

### 2. How To Plan the Demonstration

#### Choosing the Facility

- **Is food permitted?** Make sure that the site you choose for presenting the group discussion allows cooking demonstrations. If food may be brought in for tasting but not for cooking, you may be limited to bringing a prepared dish. You may also be limited in the type of food you are allowed to bring. Some organizations have special dietary restrictions. Check these out beforehand. If you are doing a cooking demonstration at a festival or outdoor fair, you may need a special permit to use cooking equipment. Most important, be sure to visit the site beforehand to look at the facilities.
- **Is water accessible?** You will need to wash your hands frequently. You may need large amounts of water for the recipes. Having a sink behind you or in the same room as the demonstration is ideal.
- **Is electricity accessible?** This is necessary if you plan to cook onsite. If electricity is in the room, but not close by, be sure to bring heavy-duty extension cords with multiple outlets. If the demonstration is outside, you may need extension cords to bring the electricity outside, or you may need a generator or gas stove.

- **Is lighting adequate?** Make sure there is enough light for participants to see what is being demonstrated.
- **Is location convenient?** Make sure the building is accessible by public transportation and parking is available.
- **Are tables and chairs available?** You will need at least one table for your demonstration. If you demonstrate several recipes, you may need more. If the demonstration is long, you will need chairs for the participants.

### Choosing the recipes

The recipes you choose depend on which principle of heart healthy cooking you want to show, the amount of time you have to prepare for the session, the amount of time you have for the demonstration, your budget, the facilities available at the presentation site, and the equipment you have available. Make sure you are familiar with your recipes and that you have prepared them at least once before the demonstration. The “Strawberry-Banana Yogurt Parfait Recipe” (page 522) is a simple and tasty demonstration.

- **Consider your message.** If you want to demonstrate how to reduce the saturated fat in food, look for a recipe that uses ground beef (to show how to drain the fat), uses skinless chicken, or uses low-fat (1%) or fat-free milk or milk products. If you want to demonstrate low-sodium cooking, look for recipes that use small amounts of salt, low-sodium ingredients, or lots of herbs and spices for flavor to replace the high-sodium condiments and sauces, such as monosodium glutamate (MSG), *tuyo* (dried salty fish), *hibi* (dried salty shrimp), *pusit* (dried squid), *bagoong* (salted fish paste), *patis* (fish sauce), and *bagoong alamang* (salted shrimp paste).
- **Consider your time.** If you have limited time before the food demonstration, look for very simple recipes that do not require a lot of ingredient preparation, such as chopping or slicing, or bring ingredients that are already prepared.

- **Determine total cooking time.** Consider the total time it takes to prepare the recipes. Read through the recipes, and look for those in which the preparation and cooking times are less than the total time you have for the demonstration. If you want to demonstrate more than one dish, determine the total cooking time for each one. Start with the dish that has the longest cooking time and then go to the next longest cooking time, and so on. That way, all the food will be done at the same time or as close to the same time as possible.
- **Demonstrate just one concept.** If you do not have the time or resources to demonstrate a whole recipe, consider demonstrating just one concept. For example, to demonstrate skimming the fat off soup, open a can of soup and use a spoon to skim off the fat. Or, to demonstrate draining the fat from ground beef, cook ground beef in a skillet and drain off the fat after it is browned.
- **Prepare in advance.** Make a list of what you need to buy from the store, and buy the food, equipment, or other things you need. Buy foods as close to the demonstration date as possible.
- **Consider food safety.** Wash your hands frequently with soap and water. You need to wash your hands whenever you touch an unclean surface, raw meats, or any part of your body. Cover your mouth and nose if you cough or sneeze, and immediately wash your hands in hot, soapy water. Keep all food that needs to be cold or frozen in a refrigerator or freezer until you are ready to go to the site. Gather and pack all the other equipment you will need first. Fill a cooler with ice or freezer packs, put the food into the cooler last, and go to the site as quickly as possible.
- **Wrap prepared dishes and ingredients tightly.** Do not let raw ingredients touch or run onto cooked ingredients. For example, keep raw meats, poultry, and fish separate from other raw or cooked vegetables. Use separate utensils, bowls, and cutting boards for these foods. Wash all utensils and cutting boards in hot soapy water when used to cut raw ingredients.
- **Have a handy supply of wet paper towels to wipe up spills as they happen.** Use a vinyl tablecloth as a table covering so spills can be wiped up easily. Keep a trash can nearby so you can easily toss in used items (such as empty cans and plastic wrap) and keep the table clear.

- **Make sure your appearance is neat and clean.** Remember that the participants will be eating the food you are preparing. Keep your hands clean. You may want to wear an apron to protect your clothes and a hairnet or scarf to keep your hair off your face.

### 3. Setting Up the Food Demonstration

- **Give yourself enough time.** Allow more time than you think you will need to set up.
- **Set up the room.** Consider the best arrangement to make sure everyone can see and hear you, and make sure you have access to electricity and water. Make sure all food-contact surfaces are clean.
- **Set up the food.** At the latest possible time before the demonstration, set out all food according to which skillet or container you will use and the order in which you will prepare it. Place all the food together for each recipe.
- **Keep cool.** If you forget an ingredient, or a pot does not boil quickly enough, let group members know. Give them examples of ingredients that can be used in place of the one you forgot. While the pot boils, go over the changes that you made to the recipe to make it more heart healthy.
- **You can begin the cooking demonstration, finally!** Explain how easy it is to prepare a recipe. Relax and have fun!

# Strawberry-Banana Yogurt Parfait Recipe

**Note:** This recipe can be used as part of a cooking demonstration. For variety, substitute fruit yogurt or sugar-free pudding for the vanilla yogurt. Plain, low-fat yogurt mixed with honey is another idea to share with the group. If fresh strawberries are not available, try thawed frozen fruit or canned fruit packed in fruit juice. If time permits, invite the group members to make their own parfait. Line up the bowls, and supply a measuring cup for the amount to be used for each layer. Group members will enjoy making their own desserts and eating the tasty treat!

1. To make the parfait, spoon 1 tablespoon of yogurt into the bottom of each of four 8-ounce wine or parfait glasses. Top the yogurt with 1 tablespoon of sliced bananas, 1 tablespoon of sliced strawberries, and  $\frac{1}{4}$  cup of graham cracker crumbs.
2. Repeat the banana, strawberry, wafer, and graham cracker layer.
3. Top with a rounded tablespoon of fat-free whipped topping, if desired. Serve the parfait immediately, or cover each glass with plastic wrap and chill for up to 2 hours before serving.

4 cups of light (no-sugar-added) vanilla yogurt or pudding

2 cups of sliced bananas  
(about 2 large bananas)

2 cups of fresh strawberries

2 cups graham cracker crumbs

*(Optional)* 1 tablespoon of fat-free whipped topping

<b>Yield:</b>	<b>Serving size</b>
<b>8 servings</b>	<b>1 cup:</b>
Calories	179
Total Fat	2 g
Saturated Fat	1 g
<i>Trans</i> fat:	0 g
Cholesterol	3 mg
Sodium	190 mg
Total Fiber	2 g
Protein	6 g
Carbohydrates	36 g
Potassium	438 mg

## Quick Fact

This nutritious yogurt and fruit treat will add color and joy to your celebrations.

The scientific content of this manual comes from the following sources:

Medline Plus Interactive Heart Attack Tutorial, 2006 <http://www.nlm.nih.gov/medlineplus/tutorials/heartattack/html/index.htm>

The Seventh Report of the Joint National Committee on Prevention, Detection, Evaluation, and Treatment of High Blood Pressure (JNC 7), 2003 <http://www.nhlbi.nih.gov/guidelines/hypertension/index.htm>

Your Guide to Lowering Your Blood Pressure with DASH, 2006 <http://www.nhlbi.nih.gov/health/public/heart/dash/index.htm>

Detection, Evaluation, and Treatment of High Blood Cholesterol in Adults (Adult Treatment Panel III), 2001 <http://www.nhlbi.nih.gov/guidelines/cholesterol/index.htm>

Your Guide to Lowering Cholesterol with TLC, 2005 [http://www.nhlbi.nih.gov/healthy/public/heart/chol/chol\\_tlc.pdf](http://www.nhlbi.nih.gov/healthy/public/heart/chol/chol_tlc.pdf)

Clinical Guidelines on the Identification, Evaluation, and Treatment of Overweight and Obesity in Adults, 1998 [http://www.nhlbi.nih.gov/guidelines/obesity/ob\\_home.htm](http://www.nhlbi.nih.gov/guidelines/obesity/ob_home.htm)

The Practical Guide: Identification, Evaluation, and Treatment of Overweight and Obesity in Adults, 2000 <http://www.nhlbi.nih.gov/guidelines/obesity/oractgde.htm>

Dietary Guidelines for Americans, 2005 <http://www.health.gov/dietaryguidelines/>

Small Steps, Big Rewards: Your Game Plan to Prevent Type 2 Diabetes, 2006 [http://www.ndep.nih.gov/diabetes/pubs/GP\\_Booklet.pdf](http://www.ndep.nih.gov/diabetes/pubs/GP_Booklet.pdf)



## **For More Information**

The NHLBI Health Information Center is a service of the NHLBI of the National Institutes of Health. The Health Information Center provides information to health professionals, patients, and the public about the treatment, diagnosis, and prevention of heart, lung, and blood diseases. Please contact the Health Information Center for prices and availability of publications.

NHLBI Health Information Center  
P.O. Box 30105  
Bethesda, MD 20824-0105  
Telephone: 301-592-8573  
TTY: 240-629-325  
Fax: 301-592-8563  
E-mail: [nhlbiinfo@rover.nhlbi.nih.gov](mailto:nhlbiinfo@rover.nhlbi.nih.gov)

Other publications are also available on the NHLBI Web site at [www.nhlbi.nih.gov](http://www.nhlbi.nih.gov).

Also see NHLBI Diseases and Conditions Index: [www.nhlbi.nih.gov/health/dci/index.html](http://www.nhlbi.nih.gov/health/dci/index.html).

**DISCRIMINATION PROHIBITED:** Under provisions of applicable public laws enacted by Congress since 1964, no person in the United States shall, on the grounds of race, color, national origin, handicap, or age, be excluded from participation in, be denied the benefits of, or be subjected to discrimination under any project or activity (or, on the basis of sex, with respect to any education project and activity) receiving Federal financial assistance. In addition, Executive Order 11141 prohibits discrimination on the basis of age by contractors and subcontractors in the performance of Federal contracts, and Executive Order 11246 states that no federally funded contractor may discriminate against any employee or applicant for employment because of race, color, religion, sex, or national origin. Therefore, the National Heart, Lung, and Blood Institute must be operated in compliance with these laws and Executive Orders.



**U.S. Department of Health and Human Services**  
National Institutes of Health



**National Heart  
Lung and Blood Institute**  
People Science Health

NIH Publication No. 08-6339  
July 2008



“What good is the grass  
if the horse is already dead?”

## Session 1

**Knowledge Is Power:  
Know Your Risk for Heart Disease**

**“The act of self goes back to self.”**

**Session 2**

**Act in Time to Heart Attack Signs**

**“No undertaking is difficult  
if pursued with perseverance.”**

## **Session 3**

**Get Energized!  
Say YES to Physical Activity**

**“If you plant, you will harvest.”**

## **Session 4**

**Help Your Heart:  
Control Your High Blood Pressure**

**“If it is work, do it fast;  
If it is food, eat it little by little.”**

## **Session 5**

**Be Heart Smart:  
Keep Your Cholesterol in Check**



**“Life is like a wheel;  
sometimes you are on top,  
sometimes you are on the bottom.”**

## **Session 6**

**Keep the Beat: Aim for a  
Healthy Weight**

“To a fearless person, no fence is too high.”

## Session 7

**Protect Your Heart:  
Prevent and Control Diabetes**

**“A heavy burden is lightened if everyone participates in carrying it.”**

## **Session 8**

**Welcome Heart Healthy  
Eating Into Your Home**

**“A wise man does not see his foot on the ground, he watches his next step.”**

## **Session 9**

**Eat in a Heart Healthy Way—  
Even When Time or Money Is Tight**

**“There is no success if there is no sacrifice.”**

## **Session 10**

**Take Control of Your Health:  
Enjoy Living Smoke Free**



**“Those who do not know how to look back at where they came from will never get to their destination.”**

**Session 11**

**Review and Graduation**

**“Dare to know; knowledge is power.”**

## **Session 12**

**Use Evaluation To Track Your Progress**  
*(Especially for Community Health Workers)*

**“Do good for all.”**

## **Appendix**

### **Activities for Training Community Health Workers**



# Healthy Heart, Healthy Family

## A Community Health Worker's Manual for the Filipino Community



U.S. Department of Health and Human Services  
National Institutes of Health



National Heart  
Lung and Blood Institute

September 2008



**U.S. Department of Health and Human Services**  
National Institutes of Health



**National Heart  
Lung and Blood Institute**  
People Science Health

NIH Publication No. 08-6339  
September 2008